

# 5153500

## FINEZZA DUE Series

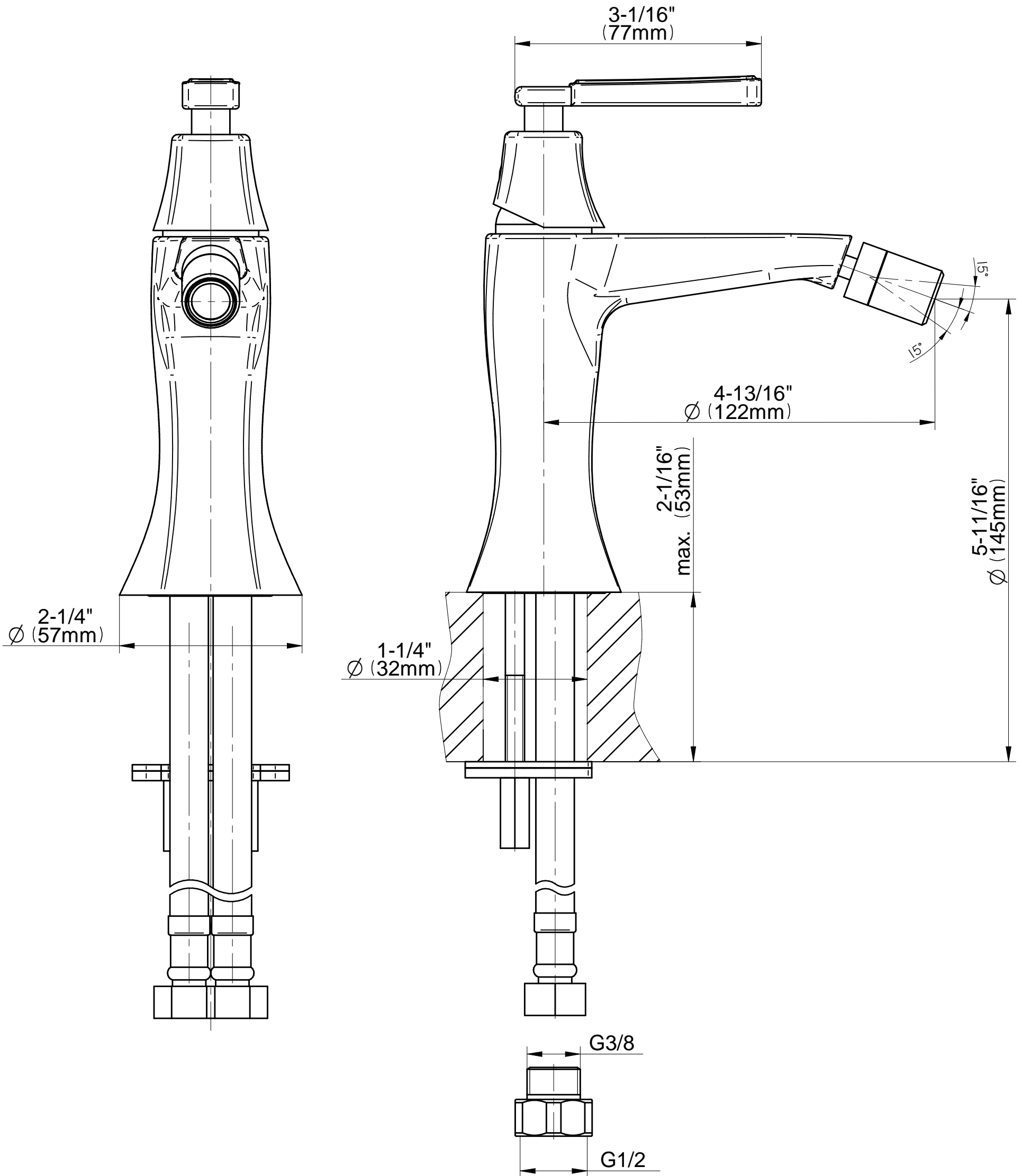

SOLID EDGE RESELLER COPY

**GRAFF**<sup>®</sup>  
CUTTING EDGE DESIGN