

Features

- Integral seat design for comfort.
- Single threshold for three-wall installation.
- Coordinates with other products in the Memoirs collection.

Material

- Acrylic.

Installation

- Left drain.

Recommended Products/Accessories

K-1733 9 kW Steam Generator
 K-702208-G54 Frameless Sliding Shower Door
 K-702208-G73 Frameless Sliding Shower Door
 K-702208-L Frameless Sliding Shower Door
 K-702209-L Frameless Sliding Shower Door
 K-705704-L Frameless Pivot Shower Door
 K-705710-L Frameless Pivot Shower Door
 K-705716-L Frameless Pivot Shower Door
 K-705722-L Frameless Pivot Shower Door
 K-705728-L Frameless Pivot Shower Door
 K-705740-L Frameless Pivot Shower Door
 K-705809-L Semi-Frameless Pivot Shower Door
 K-705822-L Semi-Frameless Pivot Shower Door
 K-705823-L Semi-Frameless Pivot Shower Door
 K-706008-D3 Frameless Sliding Shower Door
 K-706008-L Frameless Sliding Shower Door
 K-706010-L Frameless Sliding Shower Door
 K-706011-L Frameless Sliding Shower Door
 K-706012-L Frameless Sliding Shower Door
 K-706014-D3 Frameless Sliding Shower Door
 K-706014-L Frameless Sliding Shower Door
 K-706016-L Frameless Sliding Shower Door
 K-706017-L Frameless Sliding Shower Door
 K-5526 7 kW Steam Generator
 K-9132 Shower Drain
 K-23726 Drain treatment
 K-23732 Tub & shower cleaner



Codes/Standards











ASME A112.19.1/CSA B45.2
 CSA B45.5/IAPMO Z124
 ASTM E162
 ASTM E662

KOHLER® Plastic Baths and Receptors Lifetime Limited Warranty

See website for detailed warranty information.

Available Colors/Finishes

Color tiles intended for reference only.

Color	Code	Description
	0	White
	96	Biscuit
	47	Almond
	NY	Dune
	95	Ice™ Grey
	G9	Sandbar
	33	Mexican Sand™
	K4	Cashmere
	58	Thunder™ Grey
	7	Black Black™

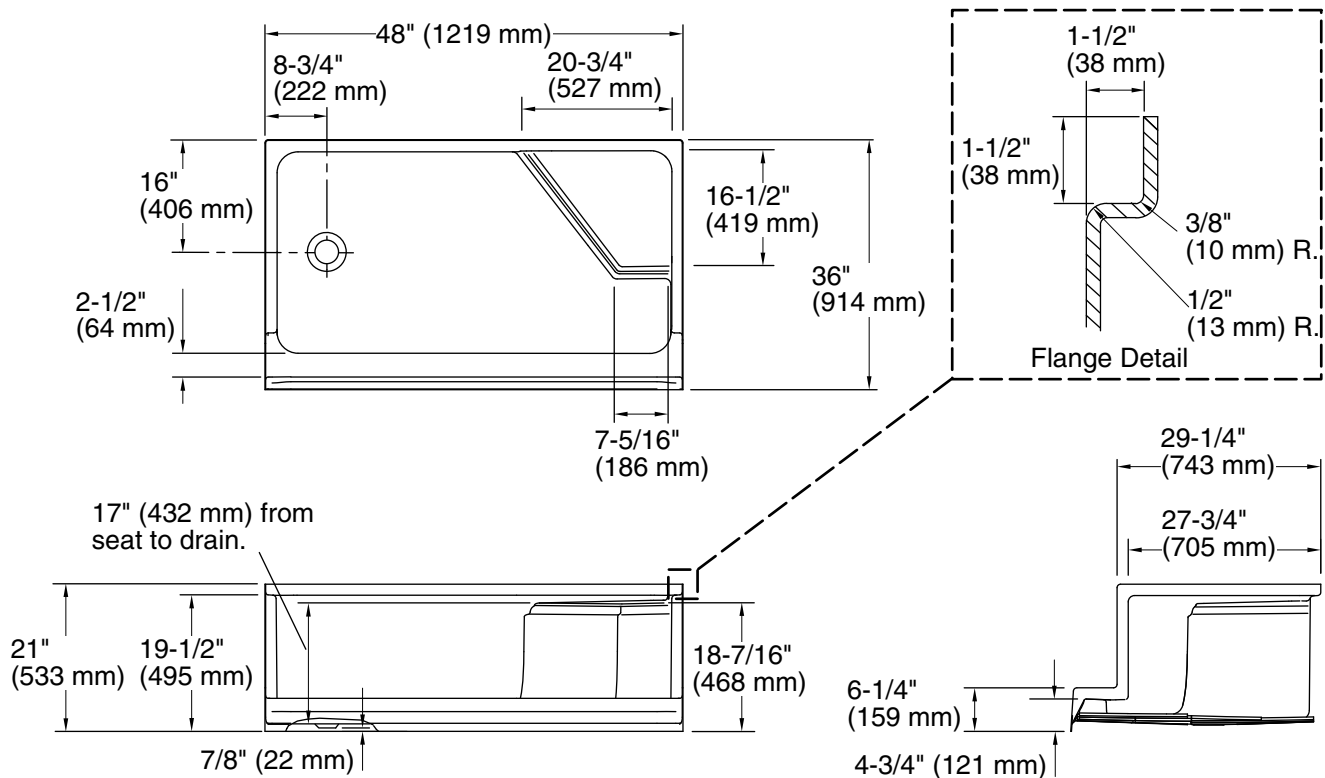

Technical Information

All product dimensions are nominal.

Installation:	Three-wall alcove
Drain location:	Left
Weight:	70 lbs (31.8 kg)
Minimum floor load:	21 lbs/ft ² (102.5 kg/m ²)

Notes

- Measure your actual product for rough-in details.
- Install this product according to the installation instructions.
- Shimming may be required to level the fixture.
- Shimming may be required between the stud frame and the fixture.
- Stud opening tolerance is + 1/4" (6 mm), - 0" (0 mm).