

Features

- Includes three 48" x 96" walls and two 96" corner joints.
- No need to install trim. Factory-installed edge provides a finished look for walls.
- Joint system hides caulk and silicone, leaving fewer places for mold to grow and simplifying cleaning.
- Coordinates with Choreograph shower accessories and storage (sold separately).

Material

- Serica®, KOHLER's proprietary composite material, offers unparalleled durability, strength, and aesthetic beauty.
- Matte finish complements any decor.
- VeinCut and CrossCut colors are based on the unique and intricate patterns of real stone; variation in the pattern is normal.
- Choreograph walls made from Serica are repairable. KOHLER's ASR network can assist in repairing surface defects, cracks, etc. Customer service can assist in scheduling a repair. Repair kit part numbers: Patterned panels: 1374534-NY, 1374534-G9, 1374534-96. Solid Panels: 1283194 - *.

Installation

- In-field trimmable.
- Adheres to water-resistant wallboard.
- For a 48" x 48" x 96" three-wall alcove or smaller.
- Intended for following use – residential (single family & multifamily) and hotel guest rooms.

Recommended Products/Accessories

K-23732 Tub & shower cleaner

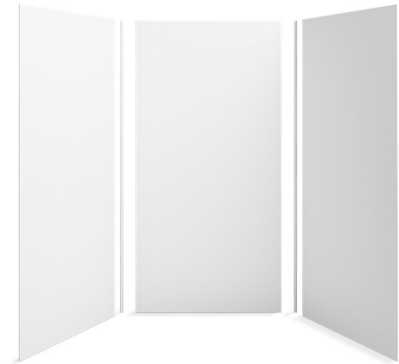

Codes/Standards













ASTM E162
ASTM E662

KOHLER® Limited Warranty – Choreograph™ Walls and Accessories

See website for detailed warranty information.

Available Colors/Finishes

Color tiles intended for reference only.

Color	Code	Description
	0	White
	96	Biscuit
	NY	Dune
	G9	Sandbar
	7NY	VeinCut Dune/Dune Combo
	896	VeinCut Biscuit/Biscuit Combo
	9G9	VeinCut Sandbar/Sandbar Combo
	W07	VeinCut in Dune
	W08	VeinCut in Biscuit
	W09	VeinCut in Sandbar
	W10	Crosscut in Dune
	W11	Crosscut in Biscuit

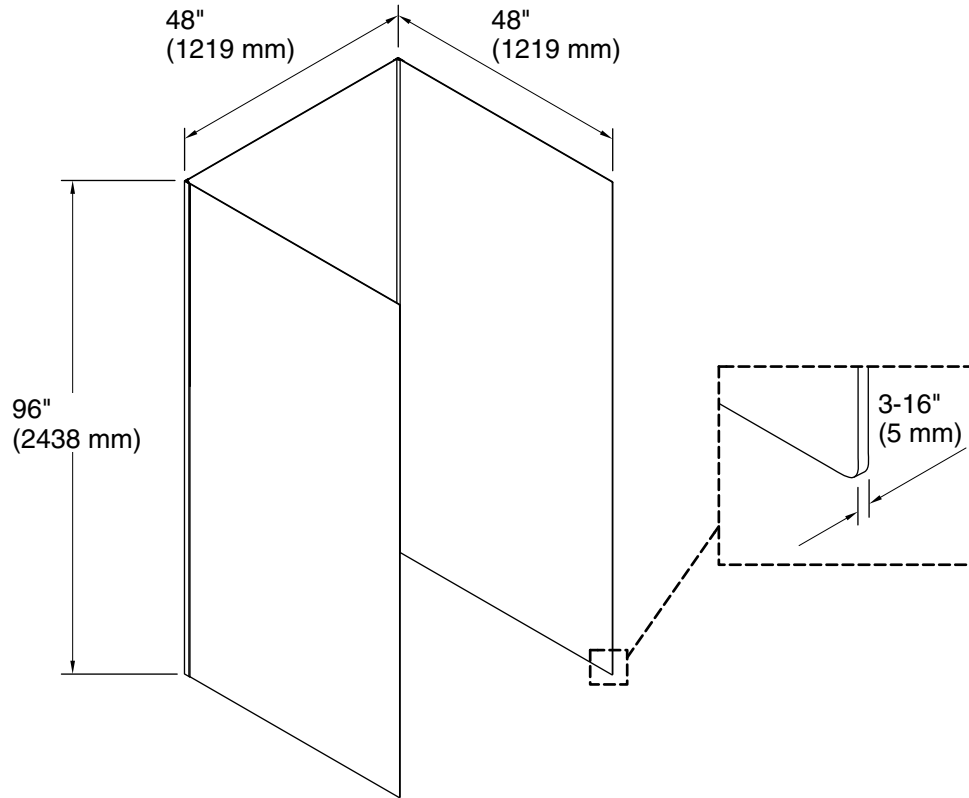

Technical Information

All product dimensions are nominal.

Installation: Three-wall alcove

Material Thickness: 3/16" (5 mm)

Notes

Measure your actual product for rough-in details.

Install this product according to the installation instructions.

Use non-solvent based construction adhesive.
For installation over tile, use 100% silicone sealant.

Corner joints allow for 3/8" (10 mm) adjustment for out-of-plumb conditions or uneven cuts.

If installing accessories, install 2x4 backing for handrails, shelves, and shower hooks, and 2x10 backing for the flip-down seat.