



EURET

A35945F

A35945H

1	AV0020403R	3	AV0028200R
2	AV0017500R	4	AV0028307R
		5	AV0026800R
		6	AV0028000R

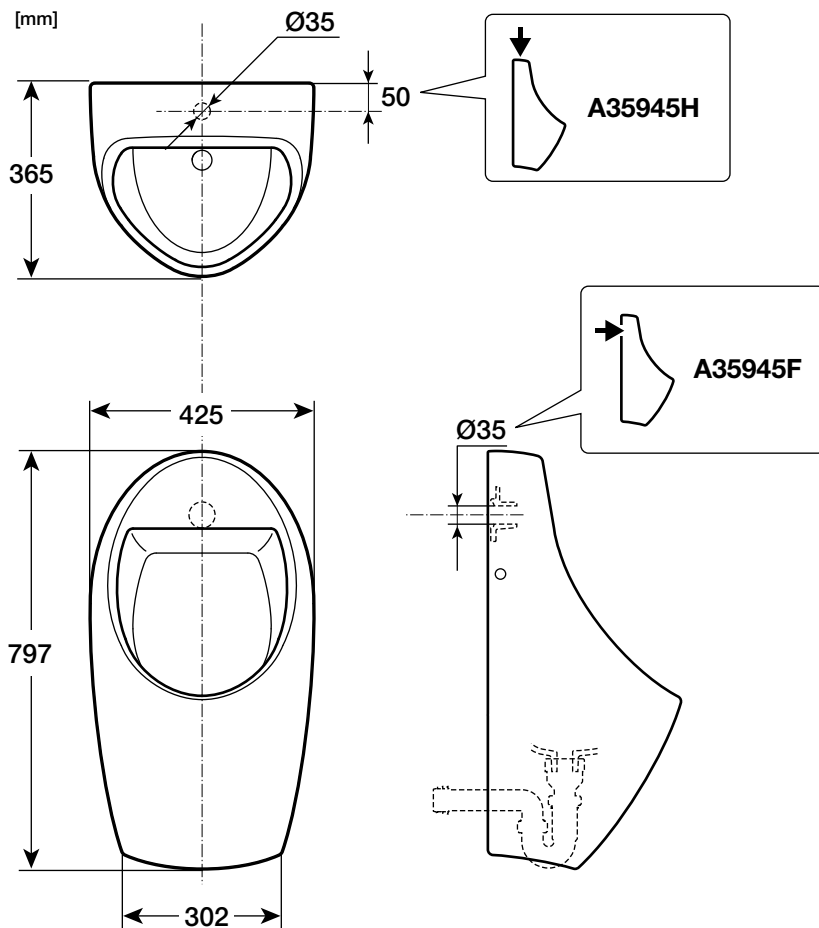

[mm]

!

≥150

AV0026800R

AV0017500R

<150

A890094100

1

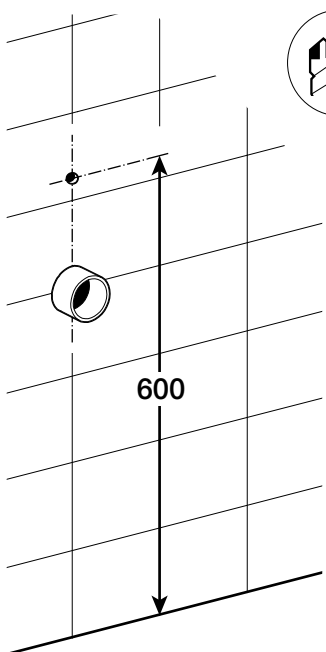
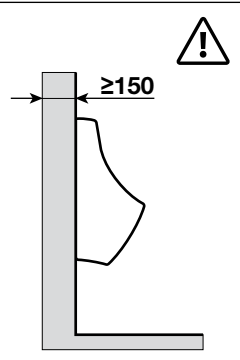
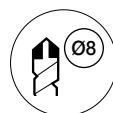

2

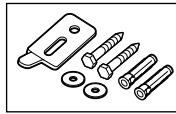
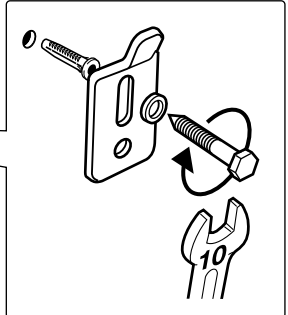
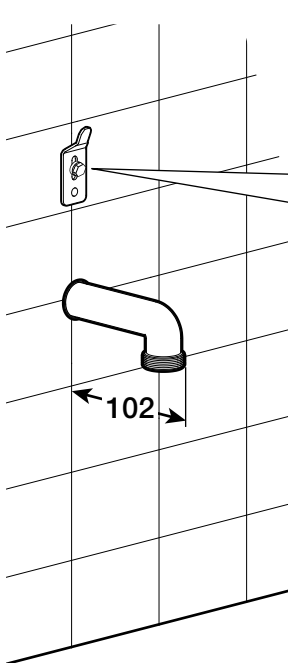

3

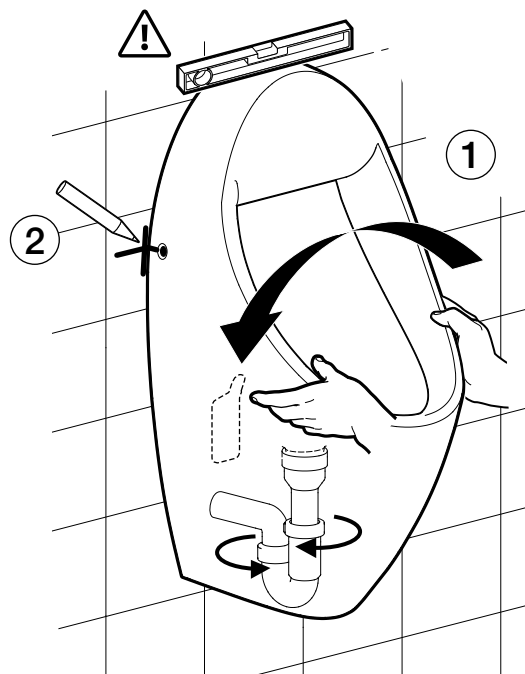

4

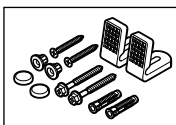
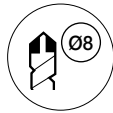
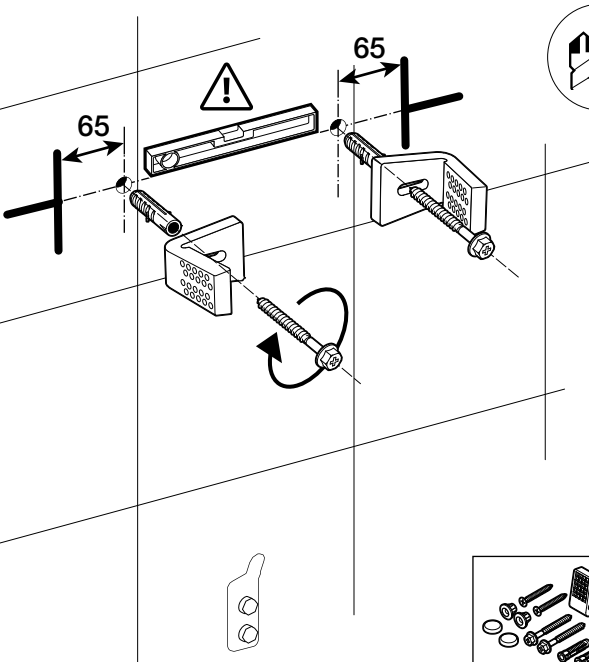

5

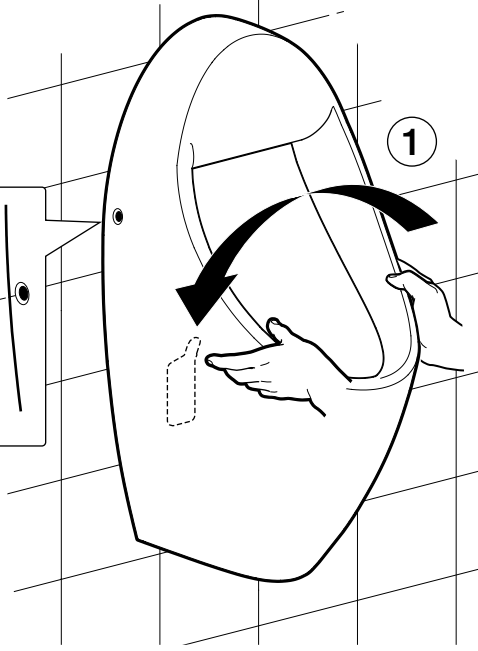
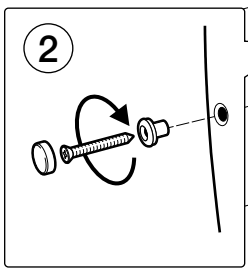

6

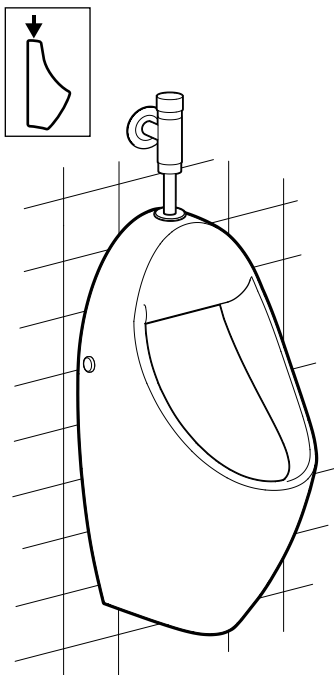
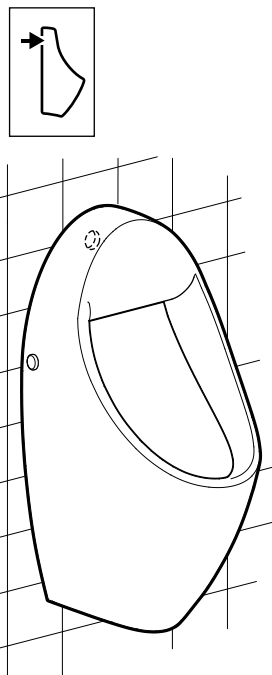



Roca Sanitario, S.A.
Avda. Diagonal, 513
08029 Barcelona
SPAIN
www.roca.com

933 LÍNEA DE ATENCIÓN
661 AL CONSUMIDOR
266 ESPAÑA 
SERVICIO TÉCNICO
ESPAÑA 



productsupport.rs@roca.net
soporteproducto.rs@roca.net