

5143900

Finezza UNO Series

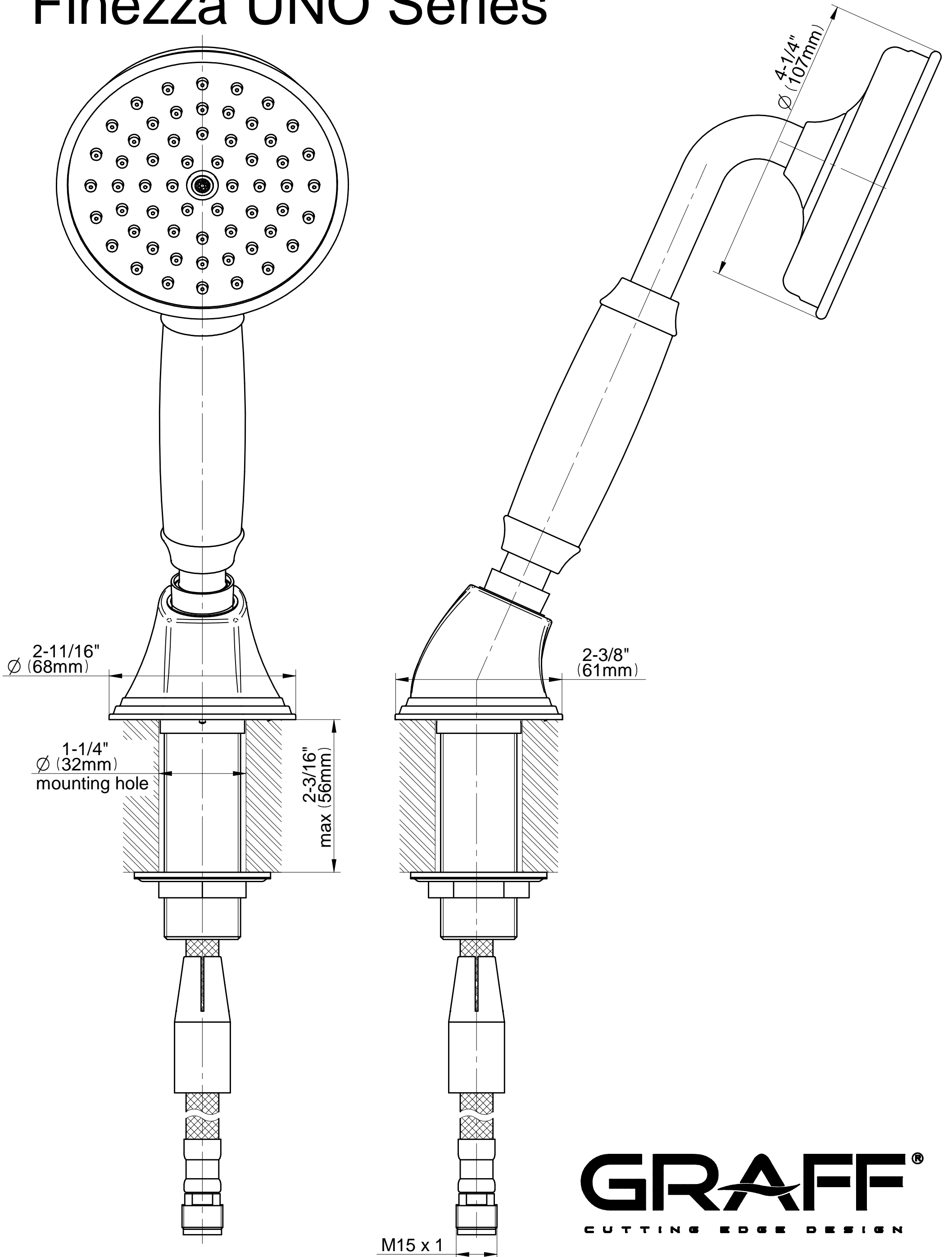

GRAFF[®]
CUTTING EDGE DESIGN