



# Brevia™ Quick-Release™

## Round-Front Toilet Seat

### K-4775

#### Features

- Quick-Release™ hinges allow seat to be unlatched from toilet for easy removal and convenient cleaning; no tools required.
- Quick-Attach® hardware for fast and secure installation.
- Color-matched plastic hinges.
- Grip-Tight bumpers hold seat firmly in place.
- Contoured seat for user comfort.
- Round closed-front seat.
- For non-residential application recommend using K-7673 or K-20111.

#### Material

- Plastic.



#### Codes/Standards







None Applicable

#### KOHLER® One-Year Limited Warranty

See website for detailed warranty information.

#### Available Colors/Finishes

*Color tiles intended for reference only.*

Color	Code	Description
	0	White
	96	Biscuit
	47	Almond
	NY	Dune
	95	Ice™ Grey
	G9	Sandbar

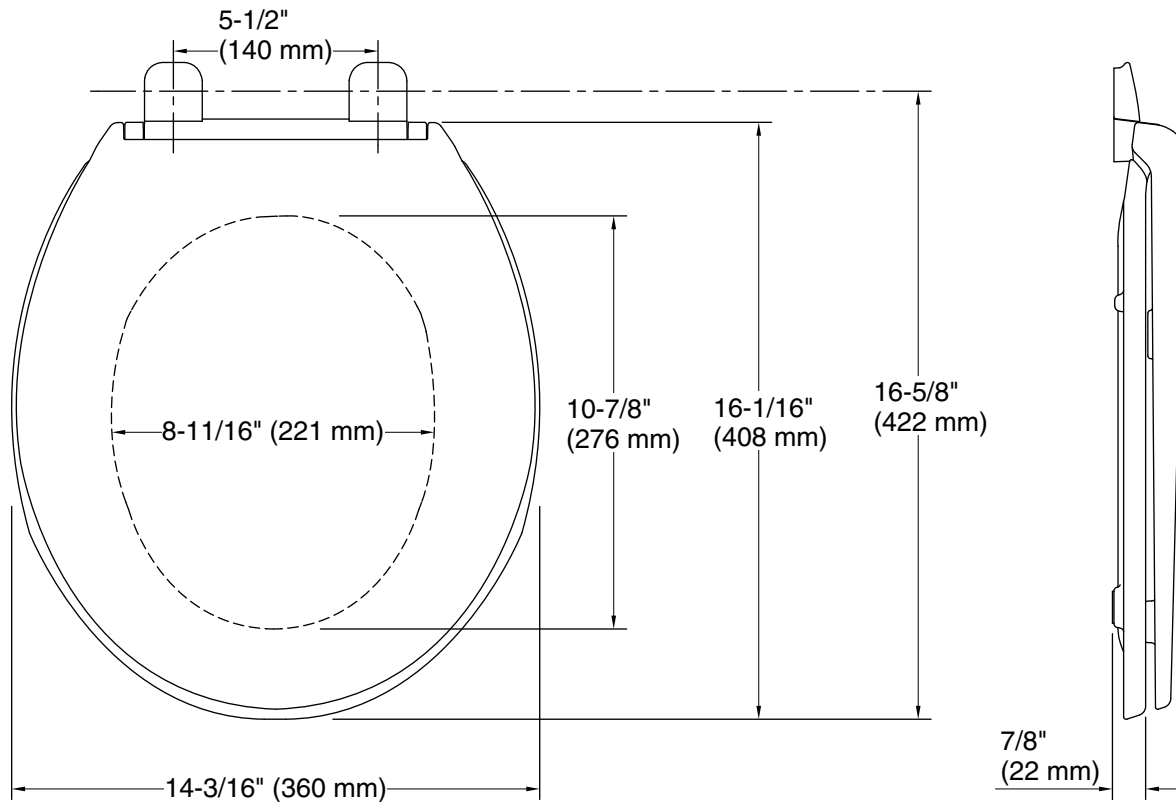

### Technical Information

All product dimensions are nominal.

Seat shape type: Round-front

Seat front type: Closed-front

Seat-mounting holes: 5-1/2" (140 mm)

### Notes

Install this product according to the installation guide.