



Kelston® Comfort Height®

two-piece elongated 1.6 gpf toilet
K-3754

Features

- Two-piece toilet.
- Elongated bowl offers added room and comfort.
- Comfort Height® feature offers chair-height seating that makes sitting down and standing up easier for most adults.
- 1.6 gallons per flush (gpf).
- Standard left-hand trip lever included.
- Combination consists of the K-4306 bowl and the K-4474 tank.
- Coordinates with other products in the Kelston collection.

Technology

- Single-flush gravity uses the force of gravity and a precision-engineered tank, bowl, and trapway to create a strong siphon during flushing.
- AquaPiston® canister allows water to flow into the bowl from all sides (360 degrees), increasing the power and effectiveness of the flush.
- Flush valve's 3:2 ratio harnesses the natural force of gravity and optimizes flush performance.
- Durable canister design has 90% less exposed seal material than a 3" flapper for leak-free performance.
- Light-touch canister flush requires a lower actuation force than a flapper.
- AquaPiston® canister flush valve optimizes flush performance and resists warping and deterioration.

Installation

- Standard 12" (305 mm) rough-in.
- DryLock® System saves installation time and helps prevent water leakage.
- Seat and supply line sold separately.

Recommended Products/Accessories

- K-4636 Cachet® Quiet-Close™ Elongated Toilet Seat
- K-5588 Purefresh® Elongated Toilet Seat
- K-4108 C³®-230 Elongated cleansing toilet seat
- K-5420 Low-Profile Bolt Caps
- K-9385 Left-Hand Trip Lever
- 1023457 Wax Ring/Hardware Kit
- 1265114 Connector Hose
- K-23726 Drain treatment

Included Components

Product consists of:

- K-4306 Toilet Bowl
- K-4474 Toilet tank, 1.6 gpf

Additional Components:

- Bolt cap accessory pack
- Tank accessory pack
- Tank cover
- Trip lever



ADA CSA B651 OBC

Codes/Standards







ASME A112.19.7/CSA B45.10
DOE - Energy Policy Act 1992
ADA
ICC/ANSI A117.1
CSA B651
OBC

KOHLER® Toilets and Seats Limited Warranty

See website for detailed warranty information.

Available Colors/Finishes

Color tiles intended for reference only.

Color	Code	Description
	0	White
	96	Biscuit
	47	Almond
	NY	Dune
	95	Ice™ Grey
	G9	Sandbar
	7	Black Black™

1-800-4KOHLER (1-800-456-4537)

Kohler Co. reserves the right to make revisions without notice to product specifications.

For the most current Specification Sheet, go to www.kohler.com.

5-8-2020 06:27 - US/CA

THE BOLD LOOK
OF **KOHLER**®

KOHLER®

Kelston® Comfort Height® two-piece elongated 1.6 gpf toilet K-3754

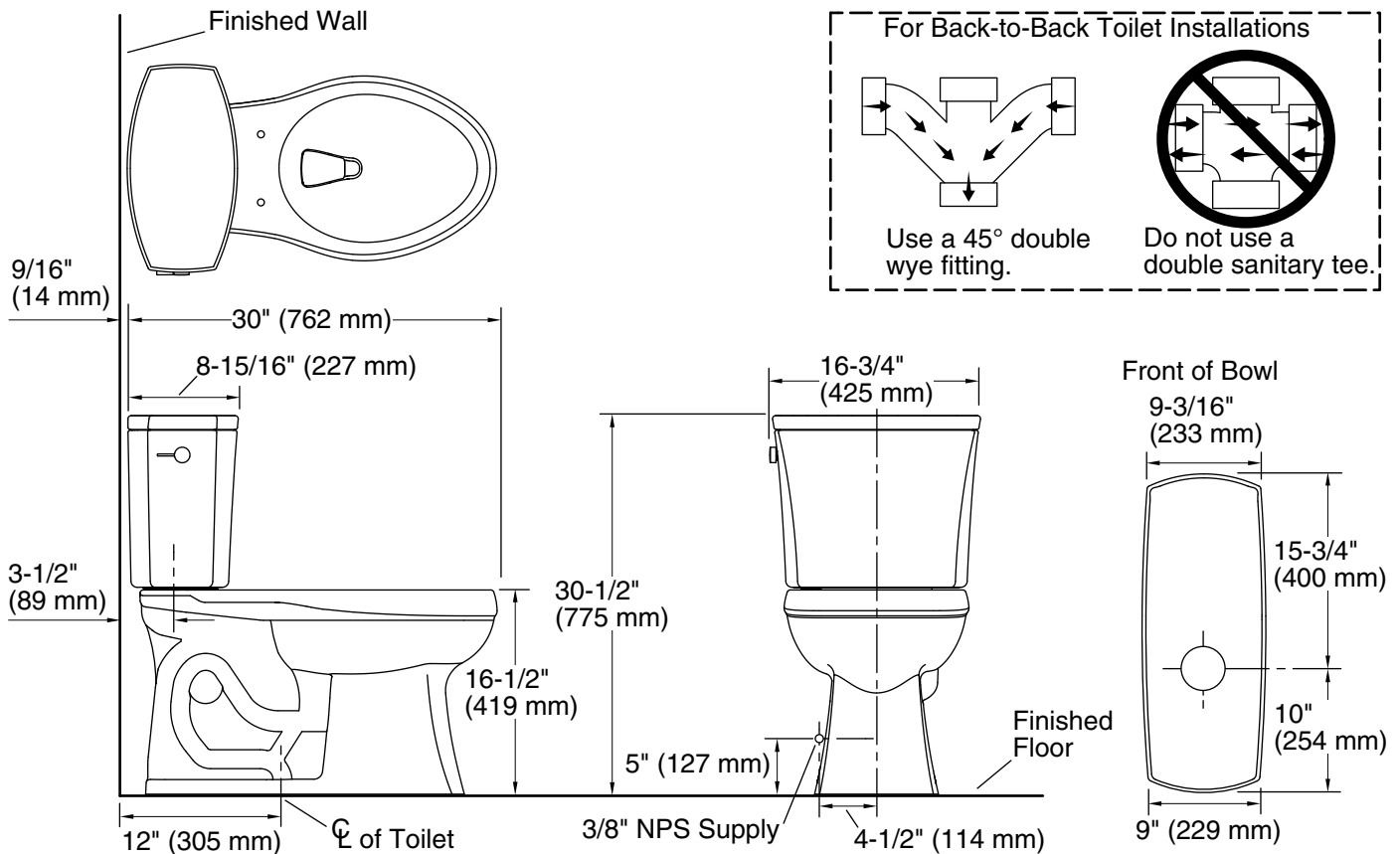

Technical Information

All product dimensions are nominal.

Toilet type:	Two-piece, Floor-mount
Waste Outlet:	Floor
Bowl shape:	Elongated
Flush type:	AquaPiston®
Trap passageway:	2-1/8" (54 mm)
Water Consumption	
Full:	1.6 gpf (6 lpf)
Water surface size:	11" x 8-3/4" (279 mm x 222 mm)
Rim to water surface:	6" (152 mm)
Rough-in:	12" (305 mm)
Seat-mounting holes:	5-1/2" (140 mm)

Notes

Install this product according to the installation instructions.

For back-to-back toilet installations: Use only a 45° double wye fitting.

The model is acceptable for left-hand Accessible compartment installations only.

ADA, OBC, CSA B651 compliant when installed to the specific requirements of these regulations.

Plumbing codes may require elongated toilets and elongated, open-front seats in public bathrooms.

Accessibility standards may require controls to be located on the open side of the toilet.

1-800-4KOHLER (1-800-456-4537)

Kohler Co. reserves the right to make revisions without notice to product specifications.

For the most current Specification Sheet, go to www.kohler.com.

5-8-2020 06:27 - US/CA

THE BOLD LOOK
OF **KOHLER**®