

Electrical Settings



SERIES ARC300/ARC600



NO.1 IN HYDRONIC SYSTEM CONTROL

Mtrl.nr: 9814 09 56 • Ritn.nr 8467 vers. B • Rev 1810



Series ARC300
Series ARC600

CE
LVD 2006/95/EC valid until April 19th 2016
LVD 2014/35/EU valid from April 20th 2016
EMC 2004/108/EC valid until April 19th 2016
EMC 2014/30/EU valid from April 20th 2016
RoHS 2011/65/EU

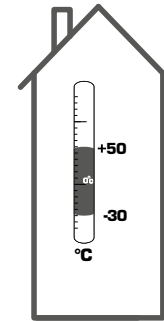

Series ARC300



Series ARC600



ARC300
Valve
Assembly
ARC300
Damper
Assembly

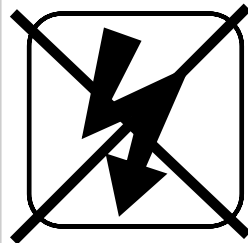

ARC361/ARC363/ARC661

**E
2A**

2-point

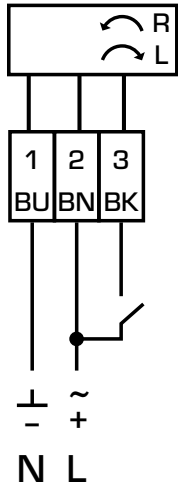

3-point

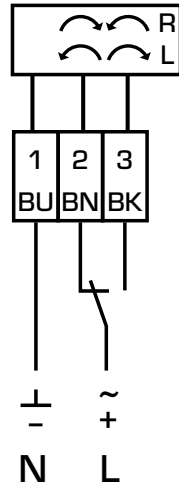

i

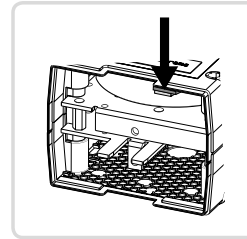
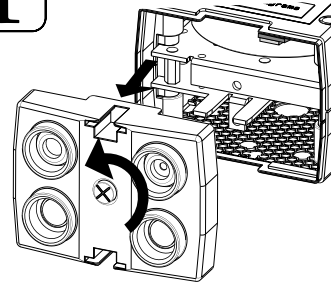

ARC361=85...265V AC/DC

ARC363=19...29V AC/DC

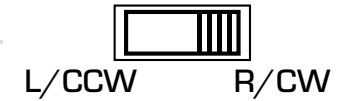

R/CW=Clockwise working direction
L/CCW=Counter clockwise working direction

ARC368/ARC369/ARC669

**E
2B**

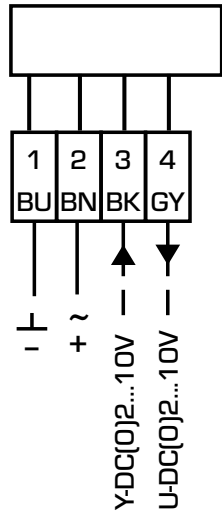

AC 19...29 V
DC 19...29 V

i

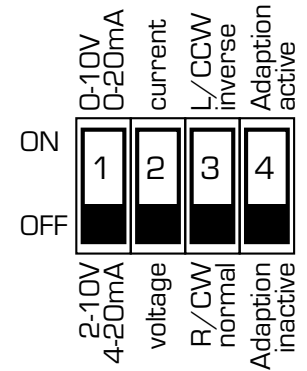
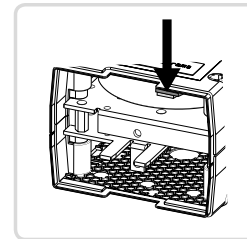
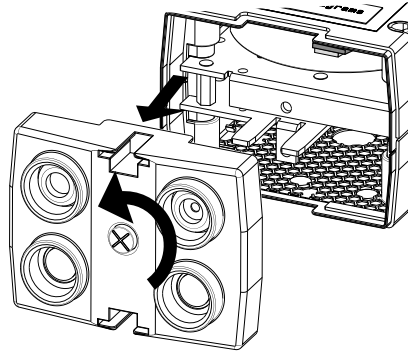

R/CW=Clockwise working direction
L/CCW=Counter clockwise working direction

ARC368/ARC369/ARC669

E 3

Y=0 - 10 V DC/0-20mA
U = 0-10 V DC

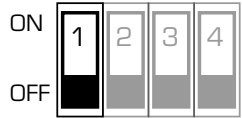

Y = 2 - 10 V DC/4-20mA



U = 2 - 10 V DC

Current (mA)

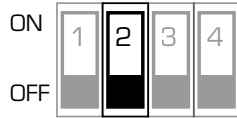

Voltage (V DC)

L/CCW

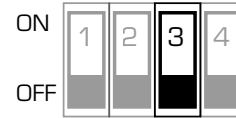

R/CW



Adaption active

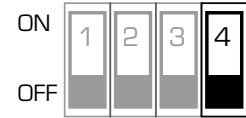

Adaption inactive

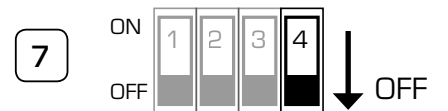
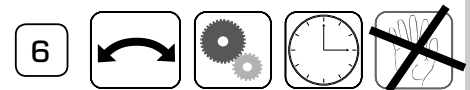
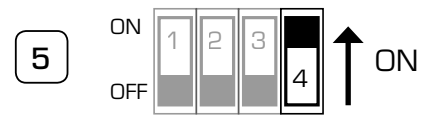
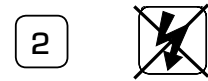

ARC368 Auxiliary switch S1/S2

E 4a

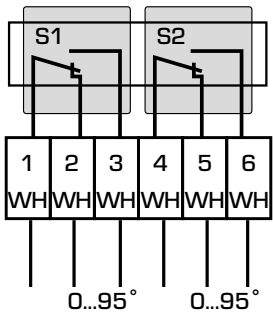

i

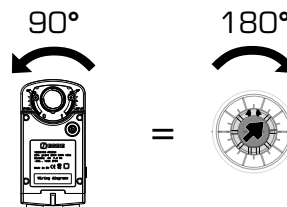
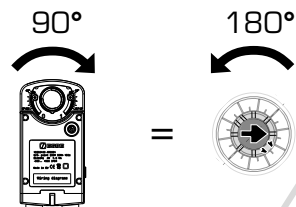
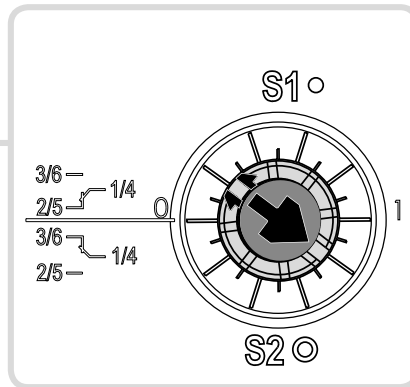
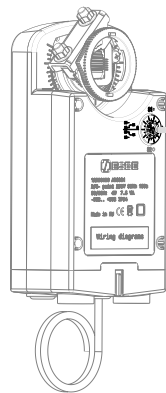

S1

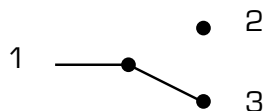
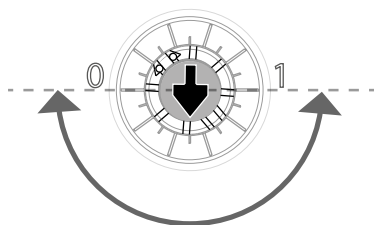
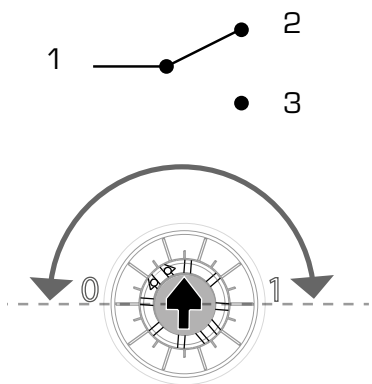

Example R/CW operation

S2

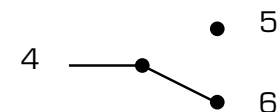
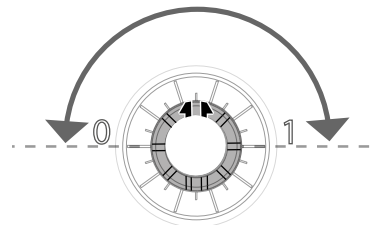
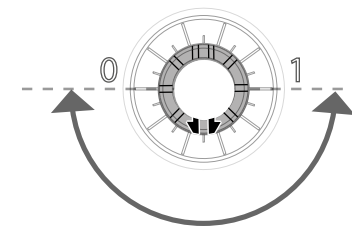
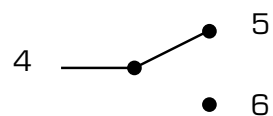

Example L/CCW operation

E 4b

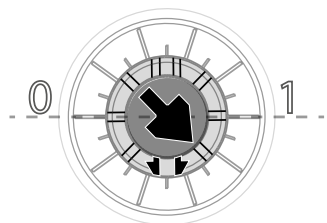

= 0° (Closed position)

Ex. **S1** 0° - 20° 1 — 3
 20° - 90° 1 — 2

Ex. **S2** 0° - 45° 4 — 6
 45° - 90° 4 — 5

E 4c

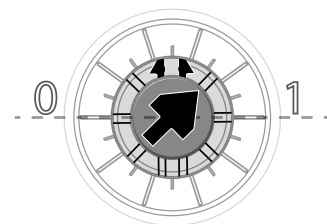

= 0° (Closed position)

Ex. **S1** 0° - 20° 1 — 2
 20° - 90° 1 — 3

Ex. **S2** 0° - 45° 4 — 5
 45° - 90° 4 — 6

All examples are general representations