

EAN CODE

3276000664819

3276000664857

3276000664871

3276000664864

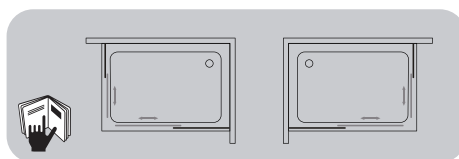

FR Notice de Montage -
Utilisation - Entretien

ES Instrucciones de Montaje,
Utilización y Mantenimiento

PT Instruções de Montagem,
Utilização e Manutenção

IT Istruzioni per il Montaggio,
l'Uso e la Manutenzione

EL Εγχειρίδιο συναρμολόγησης,
χρήσης και συντήρησης

PL Instrukcja Montażu,
Użytkowania i Konserwacji

RU Руководство По Сборке
и Эксплуатации

KZ Жинау, пайдалану және
техникалық қызмет
көрсету нұсқаулығы

UA Керівництво По Збірці
і Експлуатації

RO Manual asamblare,
utilizare și întreținere

BR Instruções de Montagem,
Utilização e Manutenção





EN Assembly - Use -
Maintenance Manual

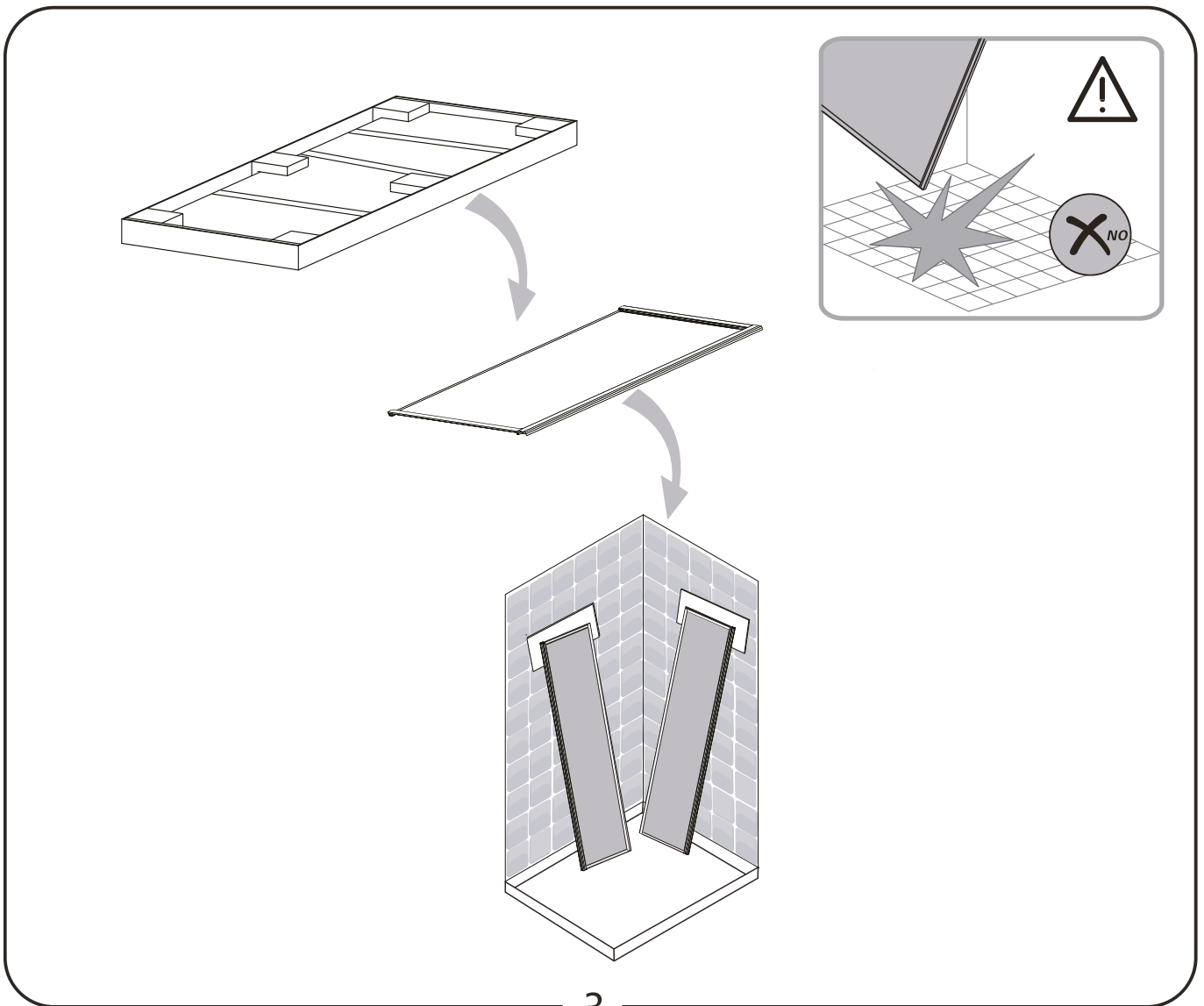
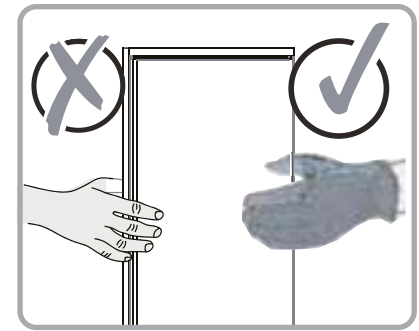
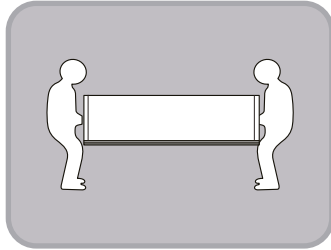
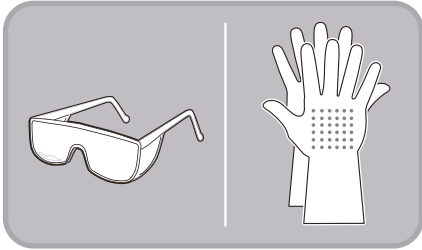
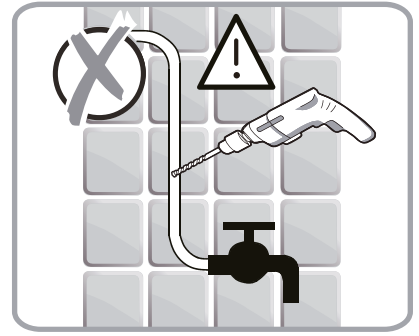
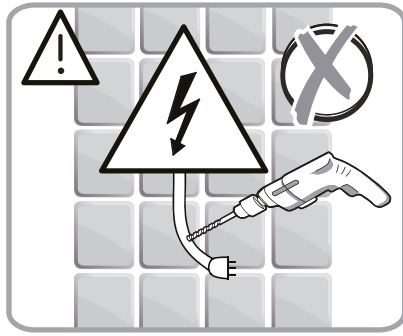
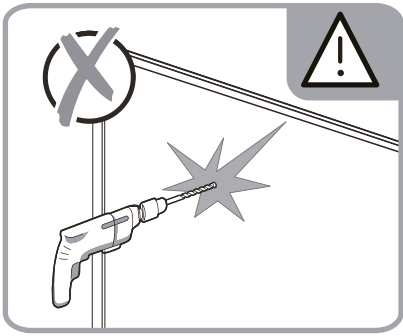

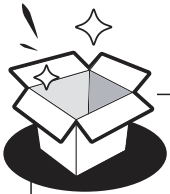
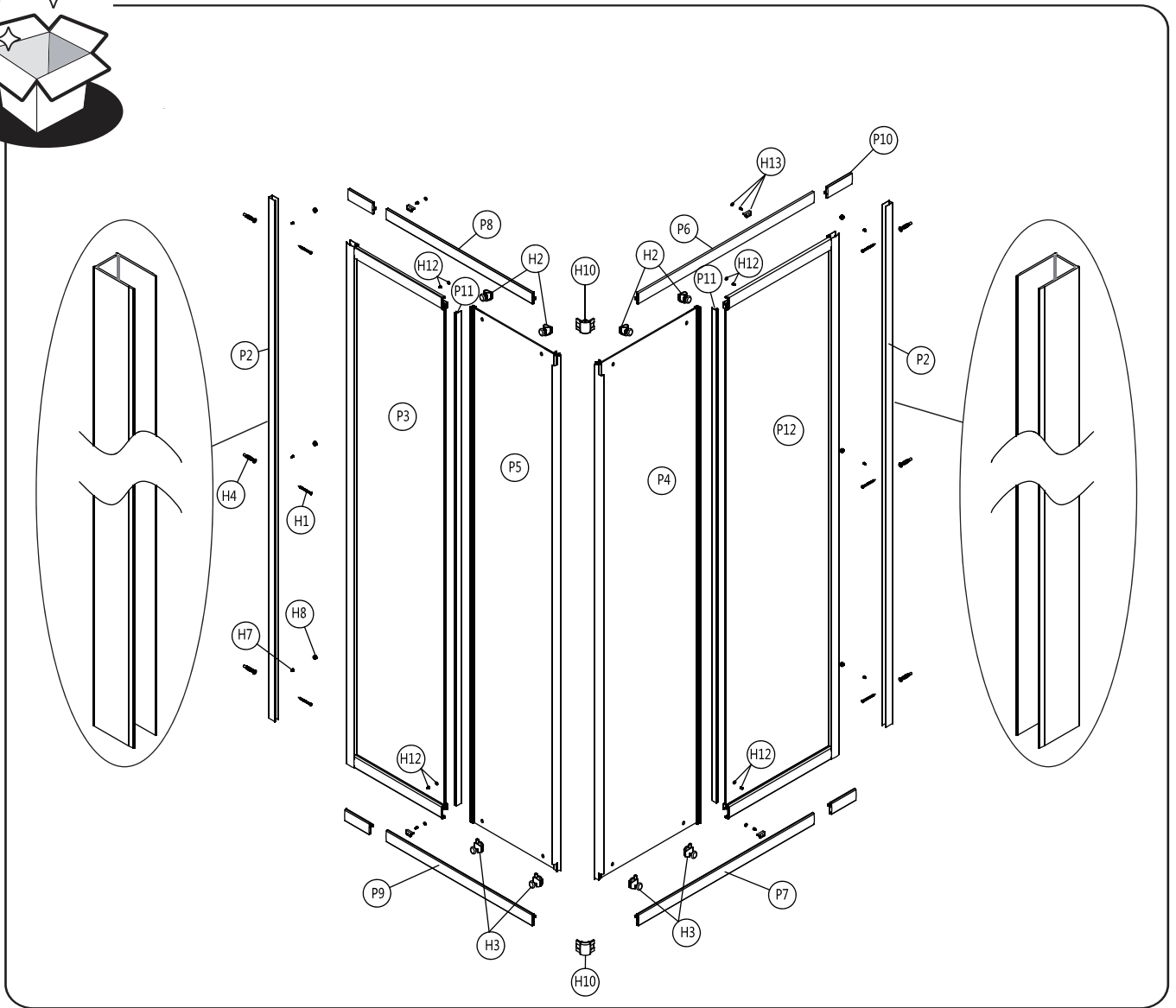
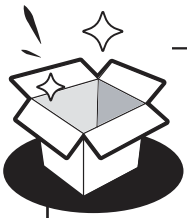
- FR** Nous vous remercions d'avoir acheté ce produit. Nous vous conseillons de lire attentivement la notice d'installation, d'utilisation et d'entretien. Nous avons conçu ce produit pour vous apporter entière satisfaction.
Si vous avez besoin d'aide l'équipe de votre magasin est à votre disposition pour vous accompagner.
- ES** Le agradecemos haber comprado este producto. Le recomendamos leer atentamente el manual de instalación, uso y mantenimiento. Este producto ha sido diseñado para proporcionarle plena satisfacción.
Si necesita alguna ayuda, el personal de la tienda estará a su disposición para guiarle.
- PT** Agradecemos a sua preferência por este produto. Aconselhamo-lo a ler o manual de instalação, utilização e manutenção com atenção. Criámos este produto para sua completa satisfação.
Se precisar de ajuda, a equipa da sua loja está à sua disposição para o acompanhar.
- IT** Grazie per aver acquistato questo prodotto. Vi raccomandiamo di leggere attentamente il manuale di installazione, utilizzo e manutenzione. Questo prodotto è stato progettato per offrirvi la massima soddisfazione.
Per ricevere assistenza, il personale del punto vendita è a vostra disposizione.
- EL** Ευχαριστούμε για την αγορά σας αυτού του προϊόντος. Σας συμβουλεύουμε να διαβάσετε προσεκτικά τις οδηγίες εγκατάστασης, χρήσης και συντήρησης. Σχεδιάσαμε αυτό το προϊόν για να σας προσφέρει πλήρη ικανοποίηση.
Αν χρειάζεστε βοήθεια, η ομάδα του καταστήματος από το οποίο αγοράσατε το προϊόν είναι στη διάθεσή σας
- PL** Dziękujemy za zakup produktu firmy. Zalecamy, aby uważnie przeczytać instrukcję instalacji, użytkowania i konserwacji. Ten produkt marki zaprojektowaliśmy, aby spełnić wszystkie Państwa oczekiwania.
W razie potrzeby pracownicy sklepu służą Państwu pomocą i są do Państwa dyspozycji.
- RU** Благодарим Вас за приобретение изделия. Рекомендуем внимательно прочитать инструкции по установке, эксплуатации и техническому обслуживанию. Изделие разработано, чтобы доставить Вам удовольствие.
Если Вам потребуется помощь, консультанты Вашего магазина находятся в Вашем распоряжении.
- KZ** Өнімін сатып алғаныңыз үшін алғыс білдіреміз. Орнату, қолдану және қызмет көрсету жөніндегі нұсқаулықтарды мұқият оқып шығуға кеңес береміз. Біз бұл өнімін сізді толықтай қанағаттандыру үшін жасап шығардық.
Егер сізге көмек қажет болса сіздің бөлшектеп сататын дүкеніңіздегі топ сізге жәрдем береді.
- UA** Дякуємо вам за покупку цього виробу. Ми радимо вам уважно прочитати інструкції з установлення, експлуатації та технічного обслуговування. Ми розробили цей виріб для того, щоб він приносив вам задоволення.
Якщо вам потрібна допомога, співробітники вашого магазину готові допомогти вам
- RO** Vă mulțumim pentru achiziționarea acestui produs. Vă sfătuim să citiți cu atenție instrucțiunile de instalare, de utilizare și de întreținere. Am conceput acest produs pentru a vă furniza satisfacție totală.
Dacă aveți nevoie de ajutor, echipa magazinului de cumpărare este la dispoziția dumneavoastră pentru a vă asista.
- BR** Obrigado por ter adquirido um produto. Nós aconselhamos a ler atentamente o manual de instalação, uso e manutenção. Concebemos um produto para proporcionar total satisfação.
Caso precise de ajuda, a equipe da sua loja estará à disposição para te acompanhar.
- EN** Thank you for purchasing this product. We recommend that you read the installation, user and maintenance instructions carefully. We have designed this product to ensure your complete satisfaction.
If you require assistance, the team at your retailer is on hand to help you.

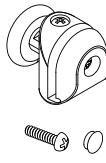
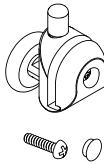
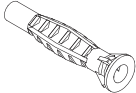

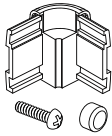

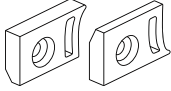
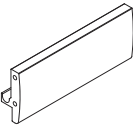
	x6	x4	x4	x6
				
	H1 ST4X45mm	H2	H3	H4 $\phi 6 \times 40 \text{mm}$
x6	x6	x2 x4	x4	x2
				
H7 ST4X12mm	H8 $\phi 9 \times 6 \text{mm}$	H10 ST4X6mm	H12 ST4X7mm	H13
x4				
				
P10				

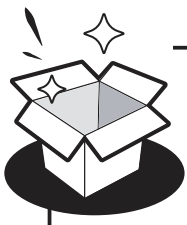

0 1 2 3 4 5 cm

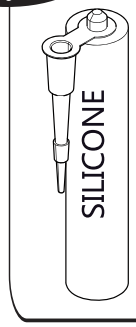
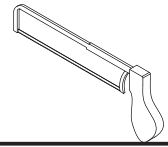
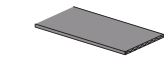
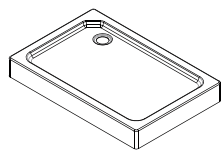
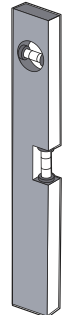
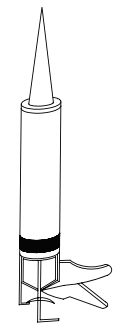
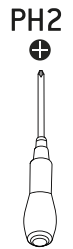
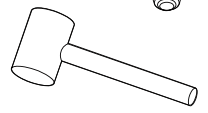
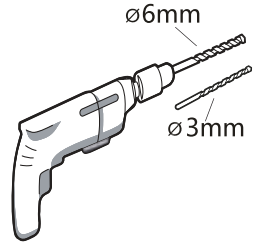
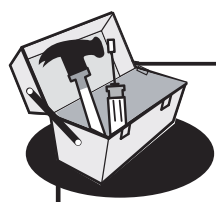
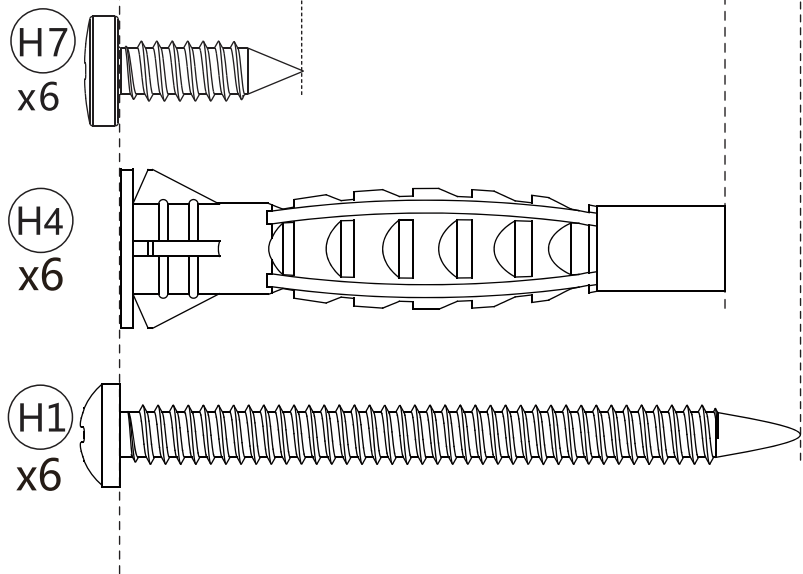
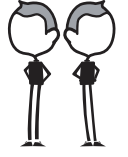



FR: Préparation / **ES:** Preparación / **PT:** Preparação / **IT:** Preparazione / **EL:** Προετοιμασία /
PL: Przygotowanie / **RU:** Подготовка / **KZ:** Дайындау / **UA:** Підготування / **RO:** Pregătire /
BR: Preparação / **EN:** Preparation



3 → 8



FR: Montage / **ES:** Montaje / **PT:** Montagem / **IT:** Montaggio / **EL:** Συναρμολόγηση /
PL: Montaż / **RU:** Сборка / **KZ:** Монтаждау / **UA:** Збірка / **RO:** Montaj / **BR:** Montagem /
EN: Assembly



9 → 41



FR: Entretien / **ES:** Mantenimiento / **PT:** Manutenção / **IT:** Manutenzione / **EL:** Συντήρηση /
PL: Konserwacja / **RU:** Уход / **KZ:** Және техникалық қызмет көрсету / **UA:** Догляд / **RO:** Întreținere /
BR: Manutenção / **EN:** Maintenance



42



FR: Mentions Légales & Consignes de Sécurité / **ES:** Instrucciones Legales y de Seguridad /
PT: Avisos Legais e instruções de Segurança / **IT:** Istruzioni Legali e di Sicurezza /
EL: Νομικό σημείωμα και οδηγίες ασφαλείας / **PL:** Uwagi Prawne i Instrukcja Bezpieczeństwa /
RU: Руководство по технике безопасности и правовым нормам /
KZ: Қауіпсіздік және құқықтық басшылық / **UA:** Керівництво з Техніки /
RO: Manual privind siguranța / **BR:** Avisos Legais e instruções de Segurança /
EN: Legal & Safety Instructions



43



- FR** Vérifiez que les chevilles murales fournies sont appropriées à votre mur (celles fournies dans l'emballage sont conçues pour le béton). Sinon, utilisez des vis et des chevilles murales adaptées au type de matériau de votre mur. Pour obtenir des conseils concernant les vis et les chevilles appropriées à votre mur, demandez à un vendeur spécialisé.
- ES** Compruebe que todos los tacos suministrados puedan ser utilizados con su pared (los incluidos en la caja son para hormigón). En caso contrario, utilice tornillos y tacos de pared apropiados para el material de su pared. Para información acerca de las fijaciones y tornillos apropiados para su pared, consulte con un asistente de ventas especializado.
- PT** Certifique-se de que as buchas fornecidas são adequadas à sua parede (as fornecidas na embalagem são para betão). Caso contrário, use parafusos e buchas adequados ao tipo de material da sua parede. Para se aconselhar acerca dos parafusos e buchas adequados à sua parede, fale com um assistente de vendas especializado.
- IT** Verificare che i tasselli da parete forniti siano compatibili con la propria parete (quelli forniti con l'articolo sono per cemento). Altrimenti, utilizzare viti e tasselli adatti per la superficie della propria parete. Per ottenere consigli e suggerimenti sulle viti e i tasselli più adatti alla propria parete, consultare un rivenditore specializzato.
- EL** Βεβαιωθείτε ότι οι παρεχόμενες στερεώσεις τοίχου είναι κατάλληλες για τον τοίχο σας (οι παρεχόμενες στη συσκευή προορίζονται για μπετό). Αλλιώς χρησιμοποιήστε βίδες και στερεώσεις τοίχου κατάλληλες για τον τύπο υλικού του τοίχου σας. Για να λάβετε συμβουλές σχετικά με τις κατάλληλες βίδες και τα εξαρτήματα για τον τοίχο σας, ρωτήστε έναν ειδικό πωλητή.
- PL** Prosimy sprawdzić, czy dostarczone kołki do ścian nadają się do użycia w posiadanej ścianie (kołki dostarczone w zestawie są przeznaczone do betonu). Jeśli tak nie jest, należy użyć śrub i kołków odpowiednich do materiału, z którego wykonana jest ściana. Aby uzyskać poradę w sprawie śrub i elementów montażowych odpowiednich do danego typu ściany, należy zwrócić się z pytaniem do wyspecjalizowanego sprzedawcy.
- RU** Убедитесь, что прилагаемые дюбеля подходят для ваших стен (входящие в комплект дюбеля предназначены для бетона). В противном случае используйте шурупы и дюбеля, соответствующие материалу стены. Для получения рекомендаций по выбору шурупов и крепежных деталей, подходящих для вашей стены, обратитесь к специалисту-консультанту.
- KZ** Жеткізілетін қабырға анкерінің (қаланған тастарды ұстастыратын темір) сіздің қабырғаңызға үйлесімділігін тексеріңіз (жиынтыққа кіретіні бетонға арналған). Олай болмаған жағдайда, қабырғаңыздың материалының түріне сәйкес бұрмашеге мен қабырға анкерін пайдаланыңыз. Қабырғаңызға сәйкес бұрмашегелер мен бөлшектер туралы ақпарат алу үшін сату бөлімінің кеңесшісіне хабарласыңыз.
- UA** Перевірте, що анкери підходять для вашої стіни (ті, що постачаються в упаковці – для бетону). В іншому випадку використовуйте гвинти й стінові анкери, що відповідають матеріалу вашої стіни. Для отримання консультацій щодо гвинтів й фітінгів для вашої стіни зверніться до відповідного продавця-консультанта.
- RO** Verificați ca toate ancorele de perete furnizate să fie adecvate pentru peretele dumneavoastră (cele furnizate în pachet sunt pentru beton). În caz contrar, folosiți șuruburi și ancore de perete adecvate pentru tipul de material din care este peretele dumneavoastră. Pentru a obține recomandări privind șuruburile și armăturile adecvate pentru peretele dumneavoastră, întrebați un vânzător specializat.
- BR** Verifique se as buchas fornecidas são adequadas para sua parede (as fornecidas na embalagem são para concreto). Caso contrário, use parafusos e buchas adequados ao tipo de material da parede. Para obter conselhos sobre os parafusos e buchas adequadas à sua parede, questione um assistente de vendas especializado.
- EN** Check that wall anchors provided are suitable for your wall (those provided in the package are for concrete). Otherwise, use screws and wall anchors suited to the type of material of your wall. To obtain advice on the screws and fittings suited to your wall, ask a specialized sales assistant.

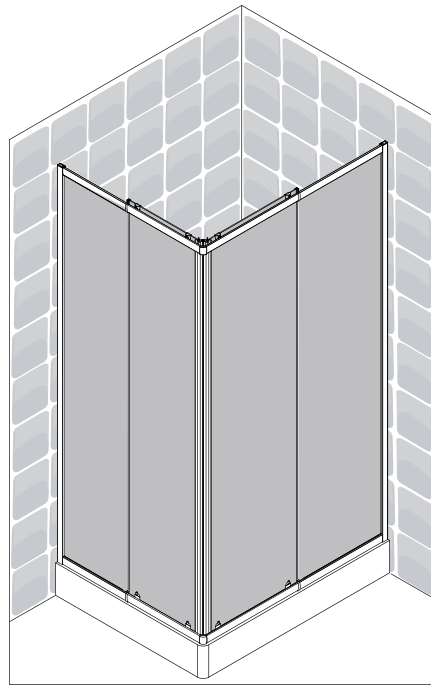

 9 → 24

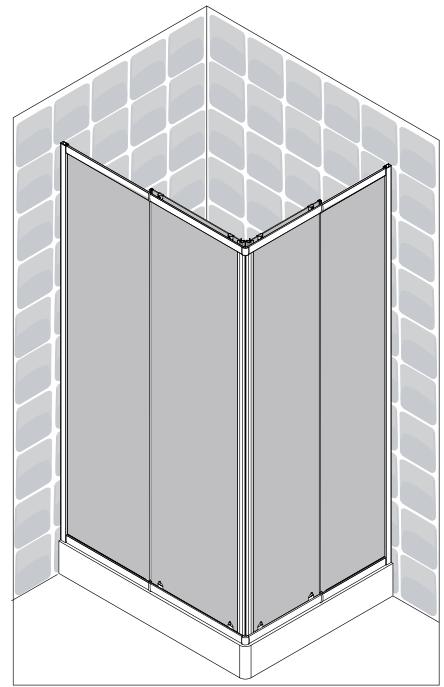

 25 → 40

EAN CODE	**MODEL NO.	SIZE(mm)
3276000664819	ESS-RAE8090-C-C	(700-800)X(800-900) X 1850
3276000664857	ESS-RAE8090-W-P	(700-800)X(800-900) X 1850
3276000664871	ESS-RAE90100-C-C	(700-800)X(900-1000) X 1850
3276000664864	ESS-RAE90100-W-P	(700-800)X(900-1000) X 1850



ESSENTIAL
(700-800) X (800-900) X 1850mm
(700-800) X (900-1000) X 1850mm

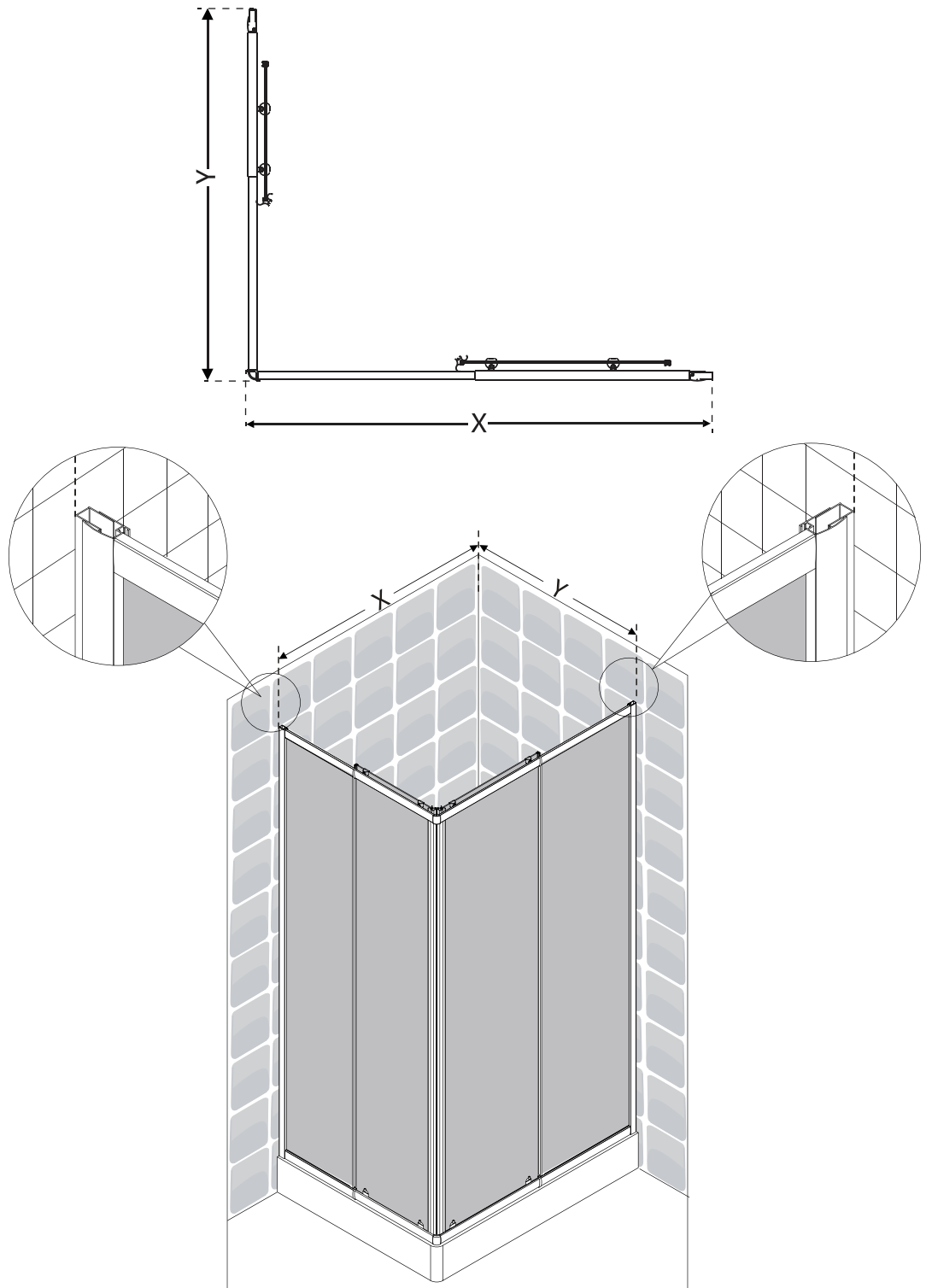



1

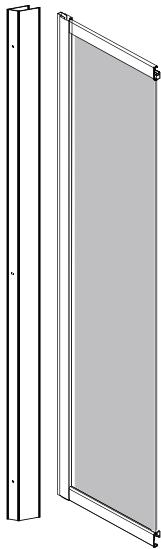

P2
x2

P3
x1

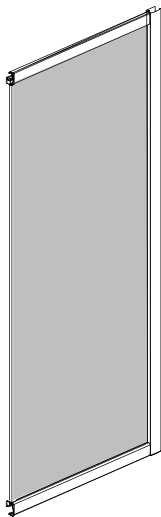

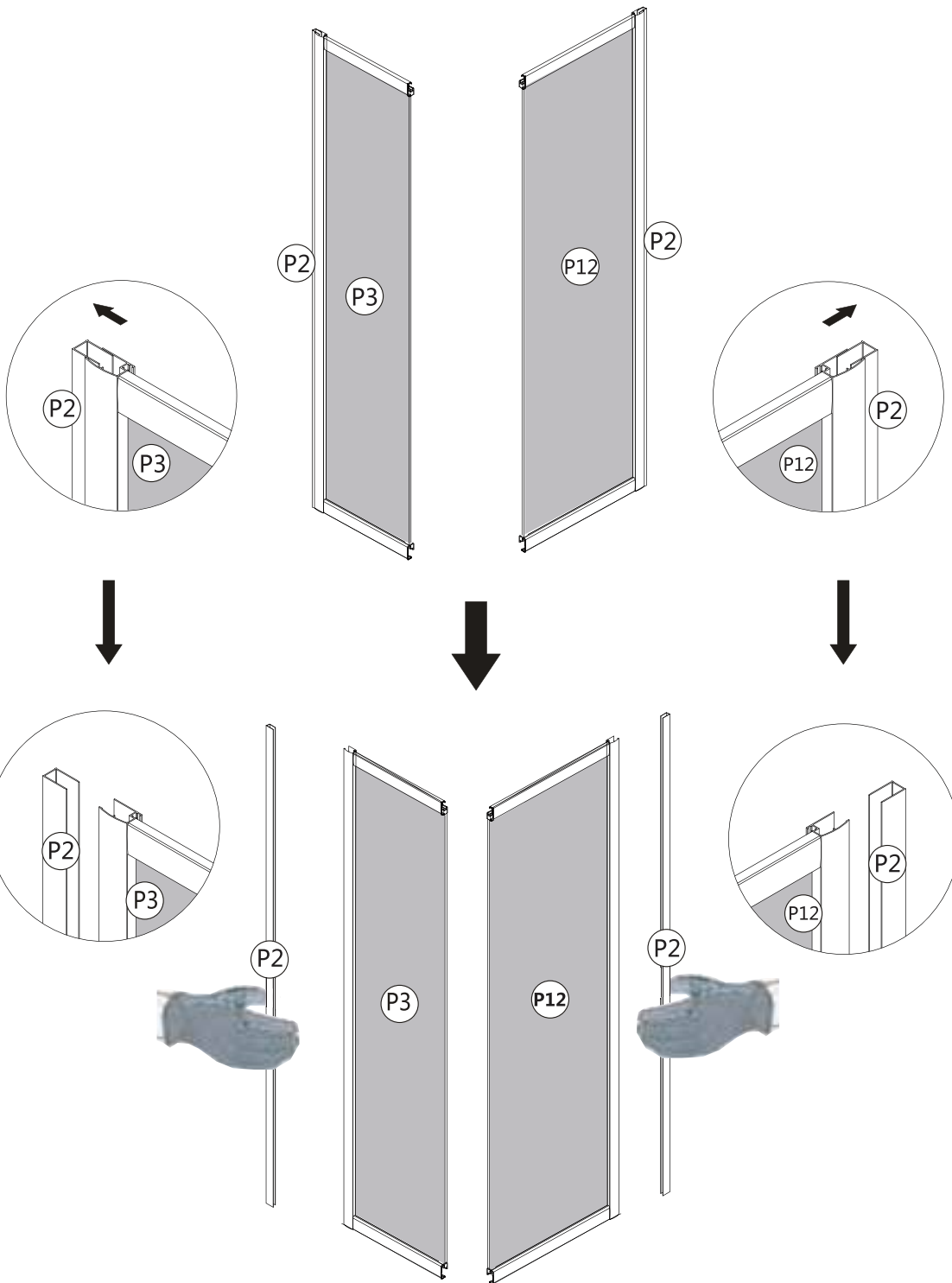

P12
x1

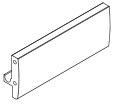

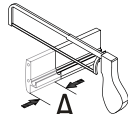
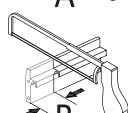
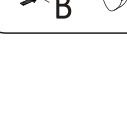

P10

X4

	EAN code	ESSENTIAL(mm)	A(mm)	B(mm)
	3276000664819	(700-800)X(800-900)	A=890-X	B=790-Y
	3276000664857	(700-800)X(800-900)	A=890-X	B=790-Y
	3276000664871	(700-800)X(900-1000)	A=990-X	B=790-Y
	3276000664864	(700-800)X(900-1000)	A=990-X	B=790-Y

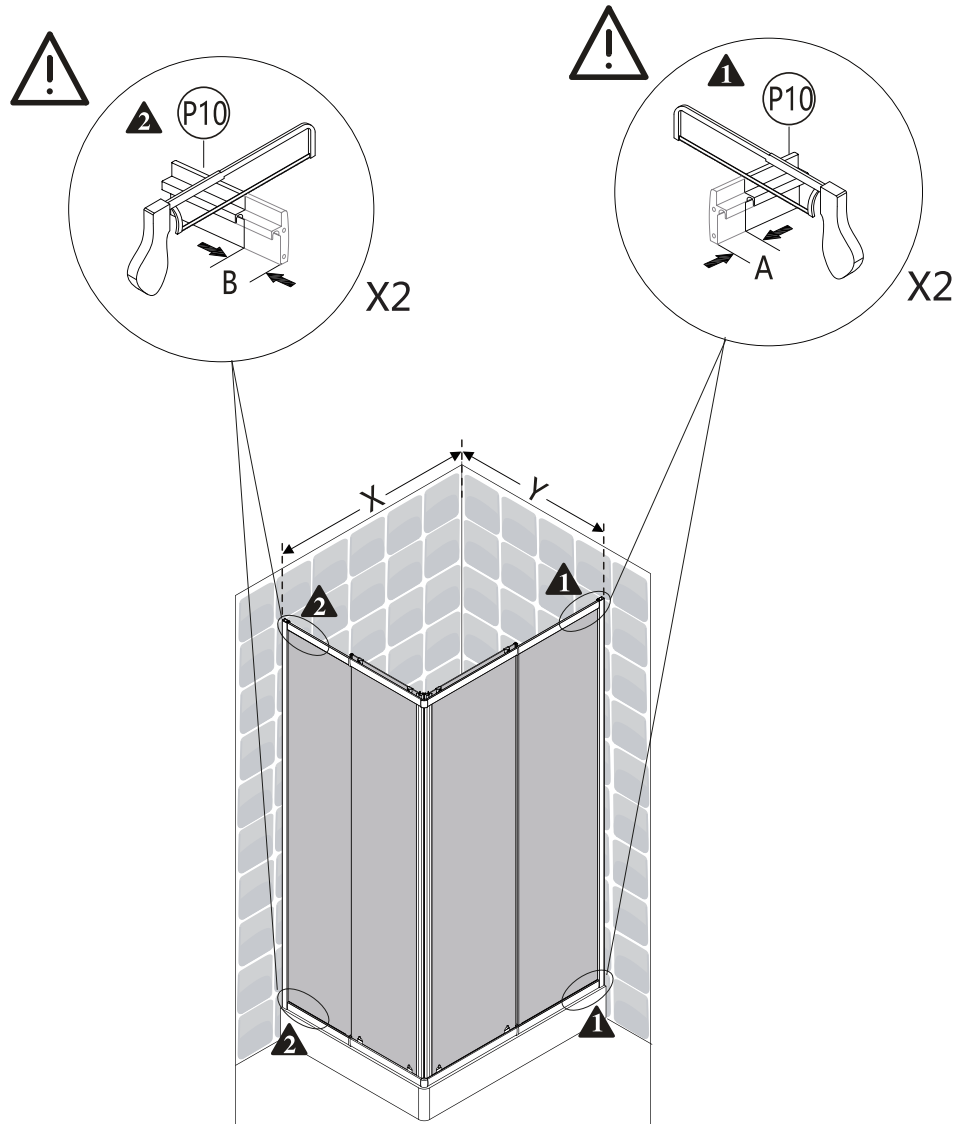

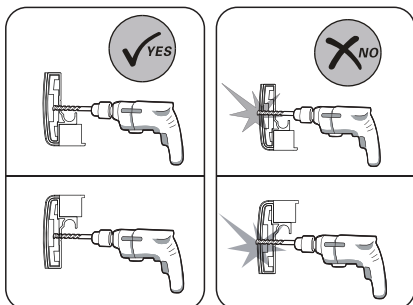
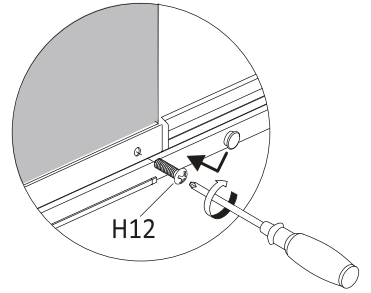
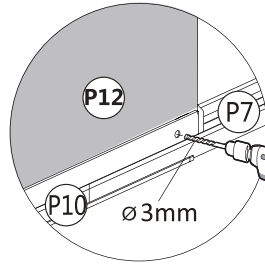
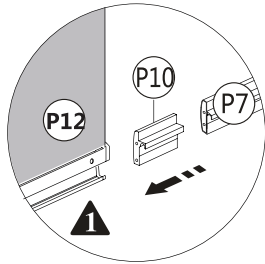
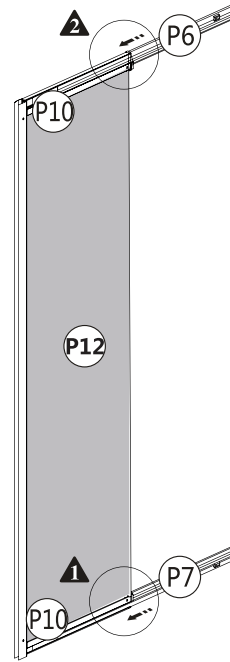
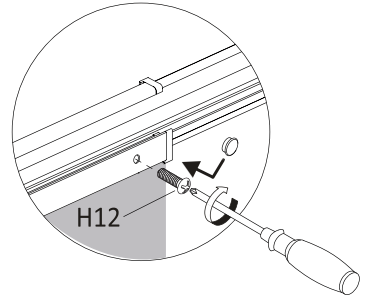
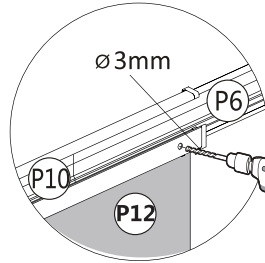
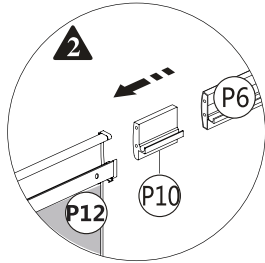
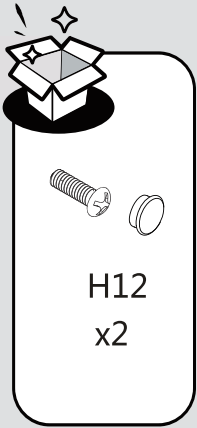

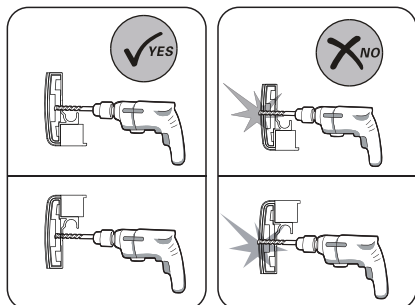
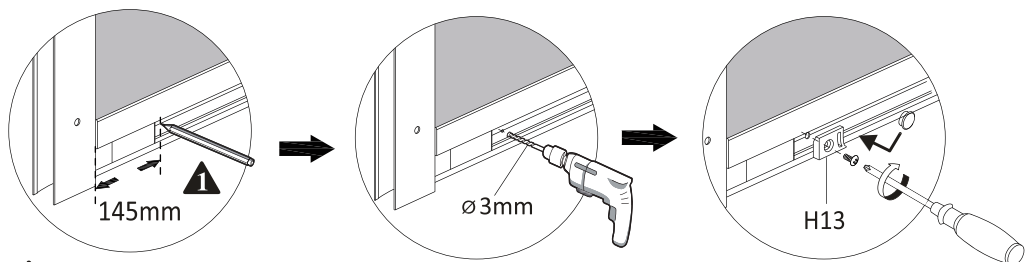
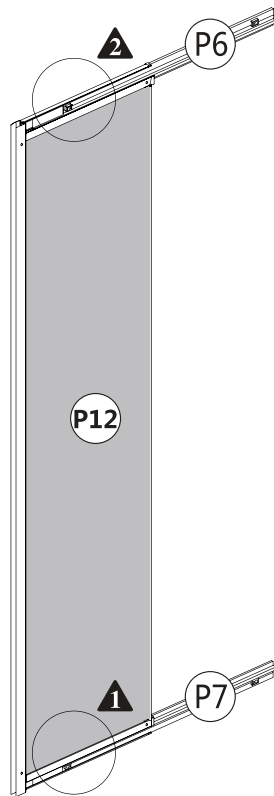
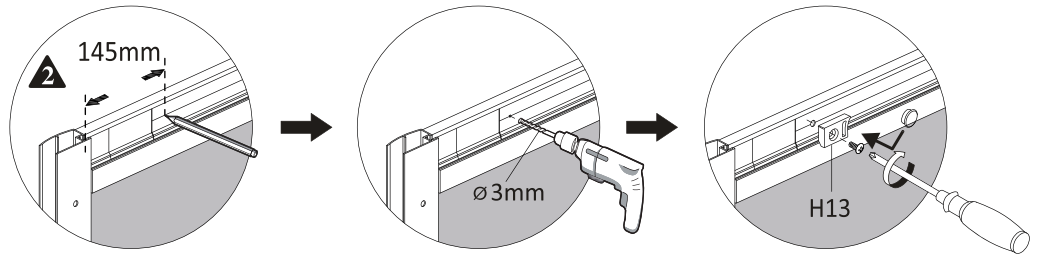
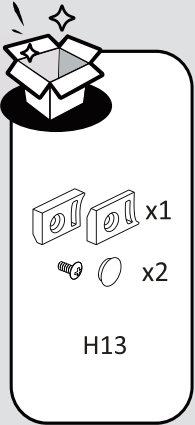

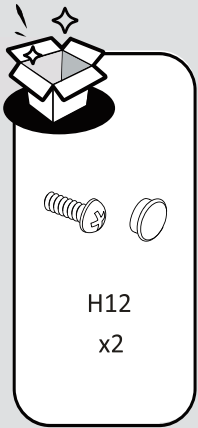

H12
x2

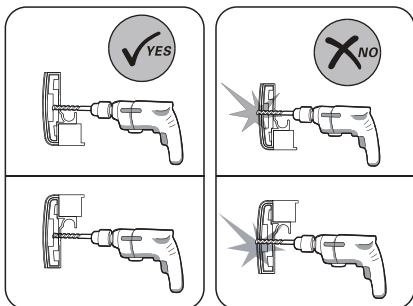
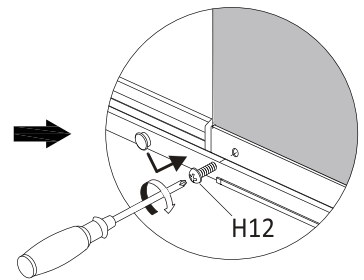
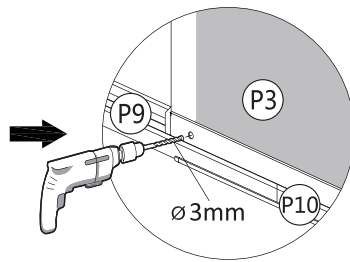
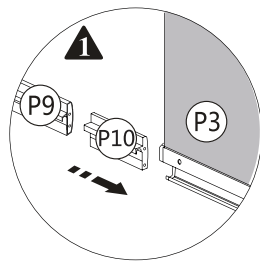
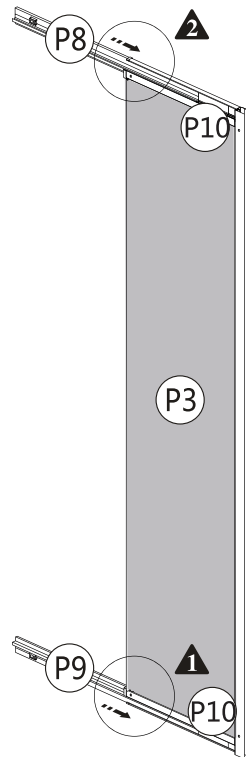
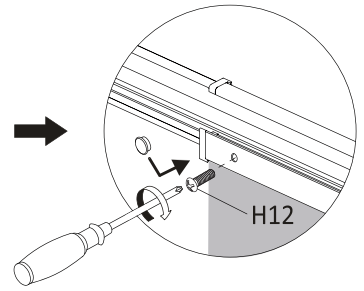
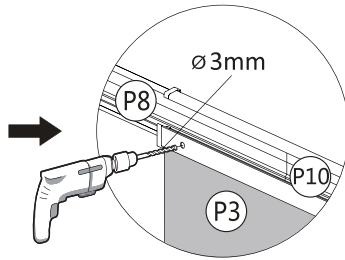
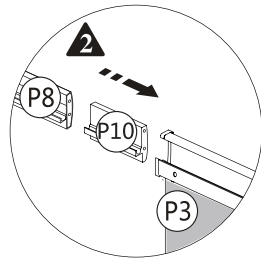

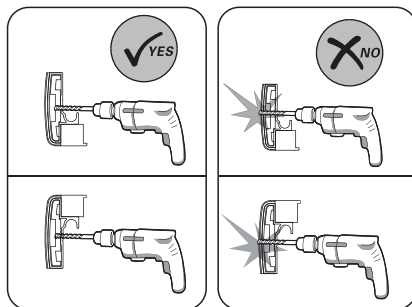
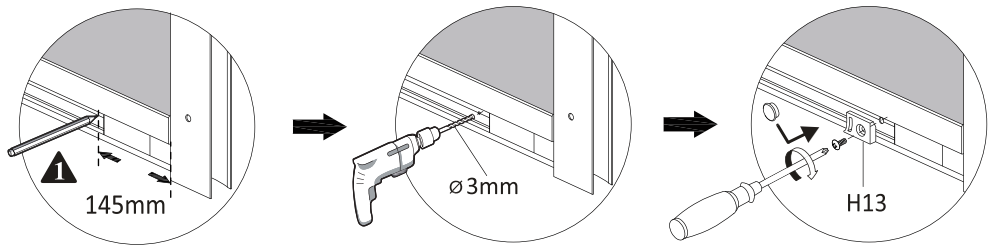
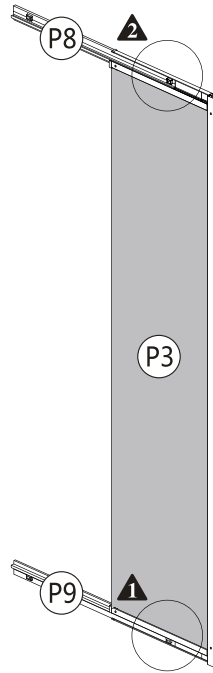
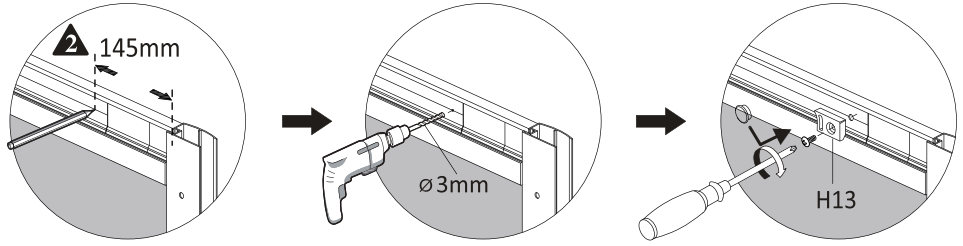
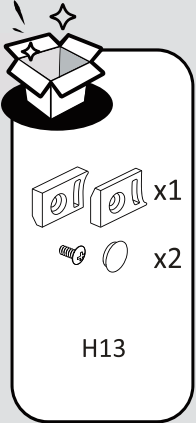

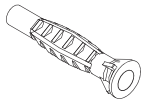

H4
x6



(P2)
X2

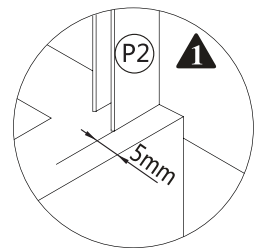
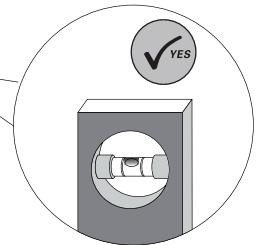
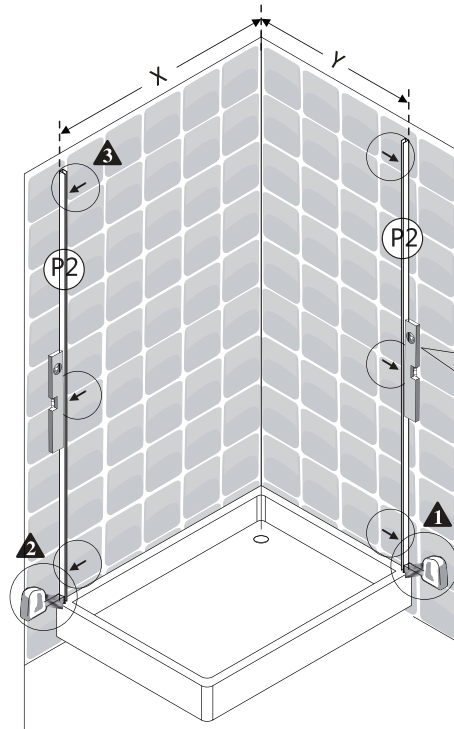
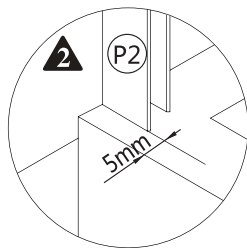
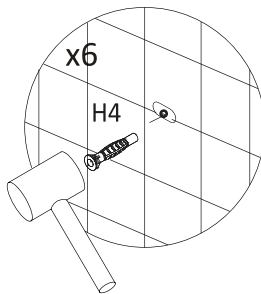
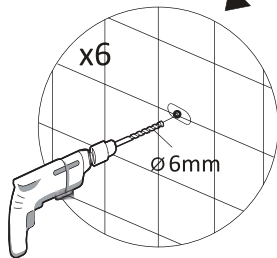
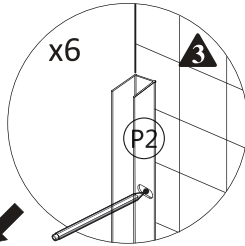
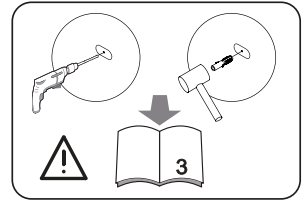

5mm minimum
 5mm mínimo
 5mm mínimo
 5mm mínimo
 5mmελάχιστο
 5mmminimalny
 5mmминимальный
 5mmминимум
 5mmмінімальний
 5mmminim
 5mm mínimo
 5mm minimum

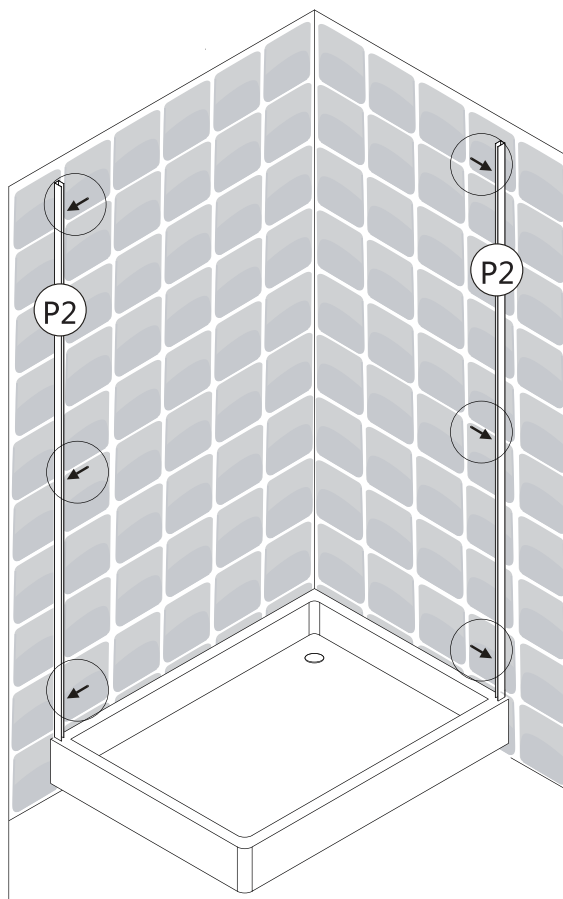
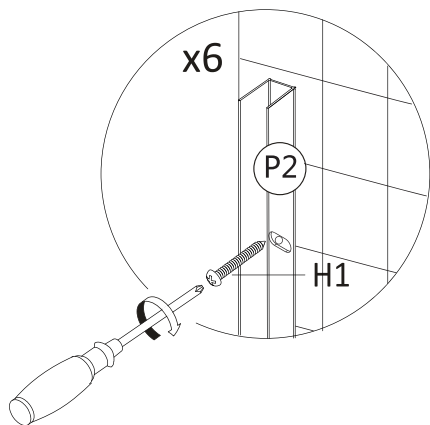
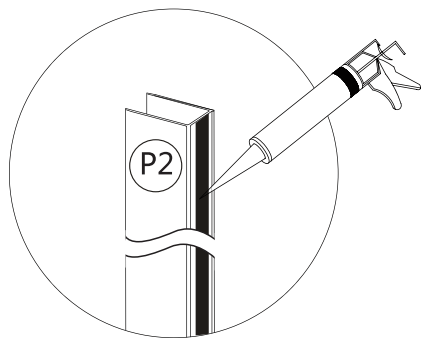
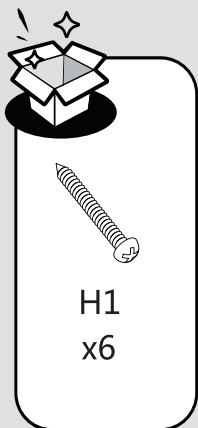



9

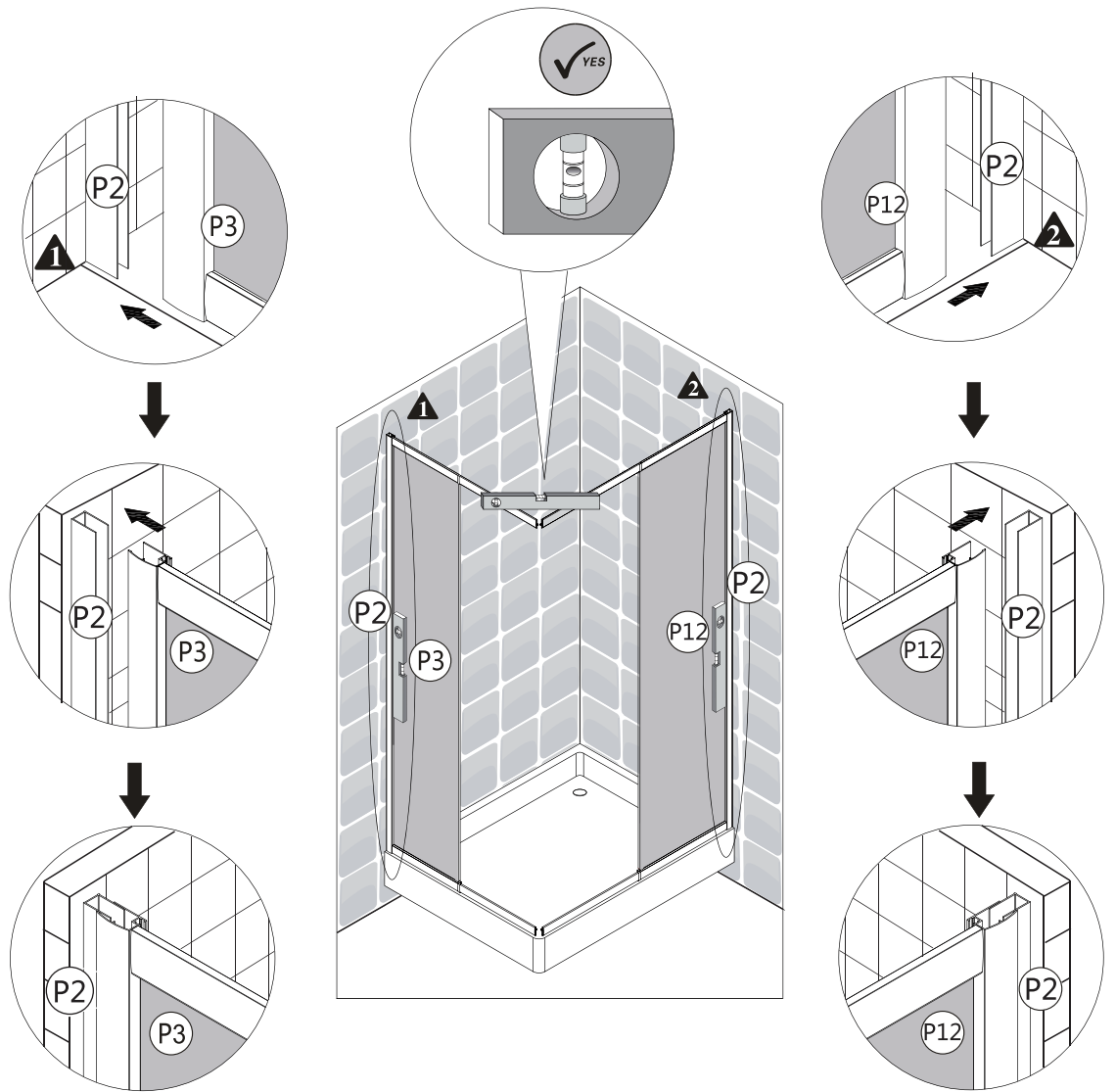



10

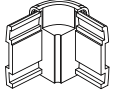

x2



x4

H10

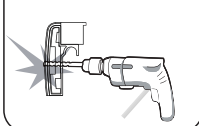
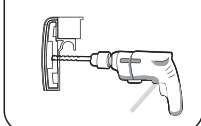
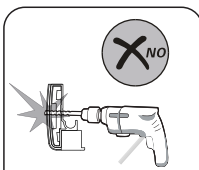
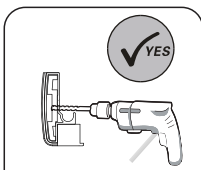
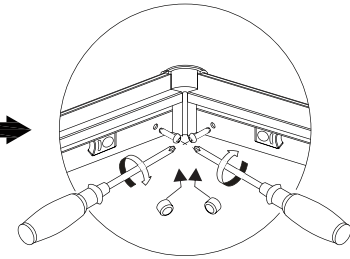
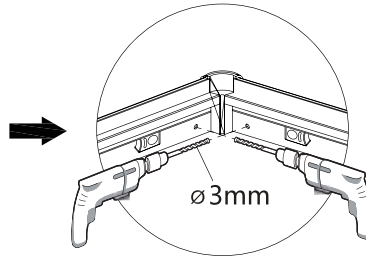
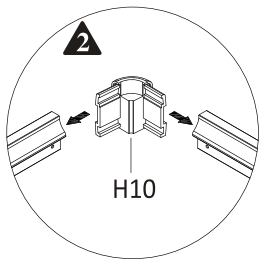
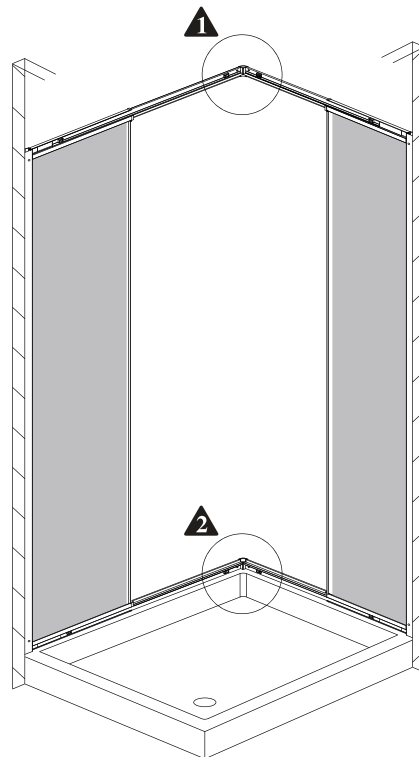
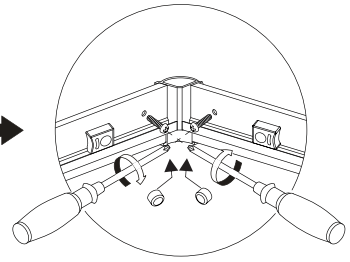
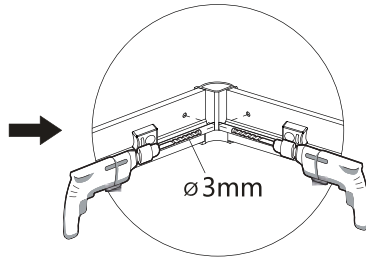
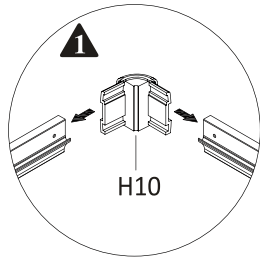

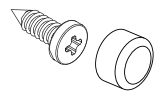

H7 H8
x6 x6

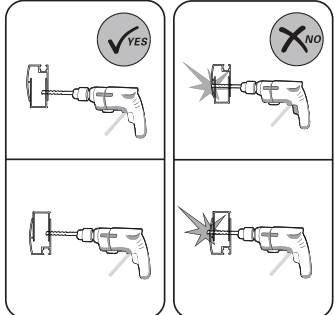
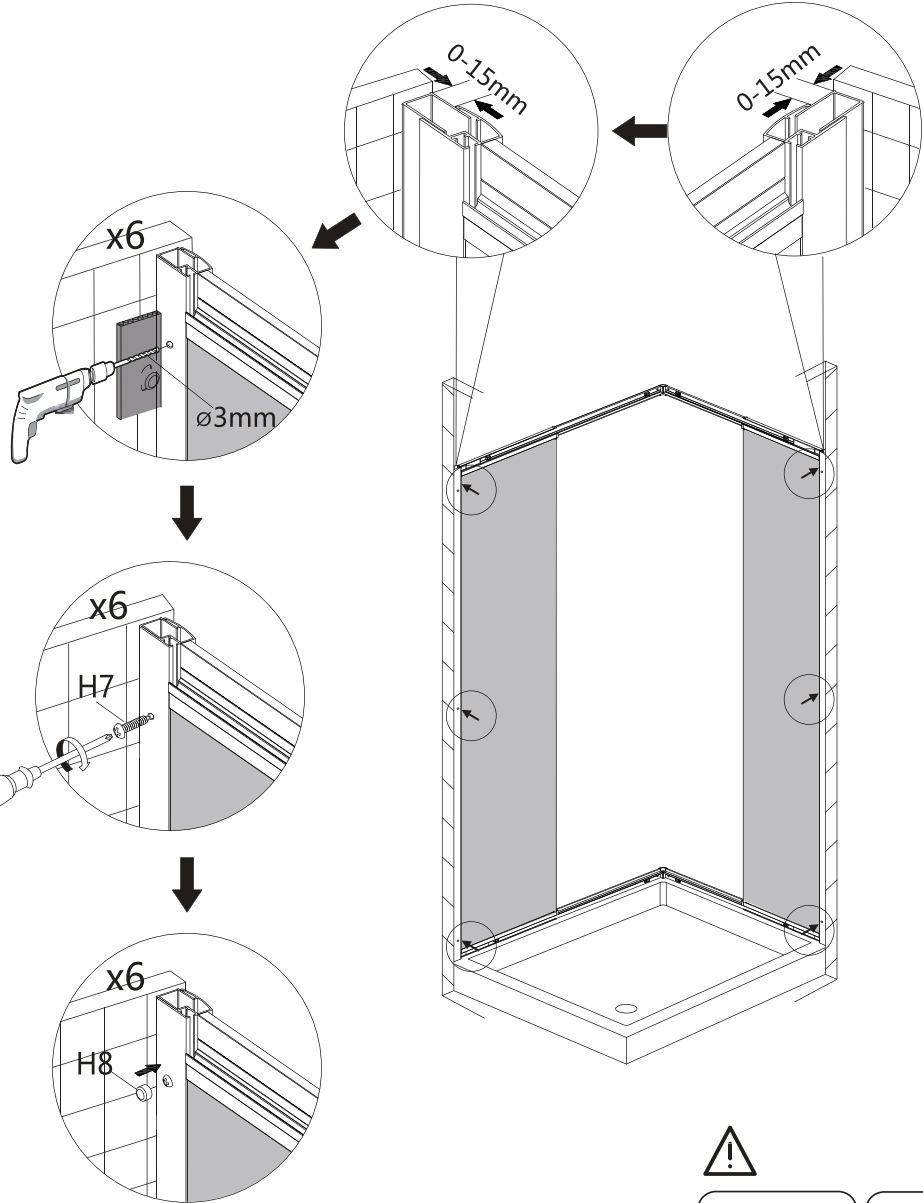



H2
x2



H3
x2

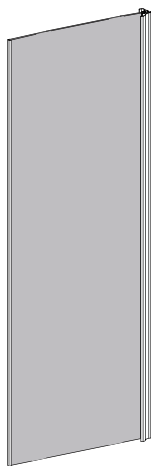

P4

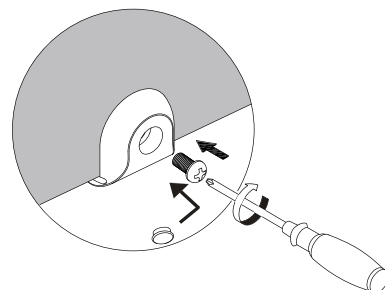
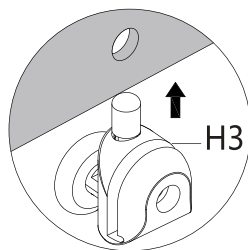
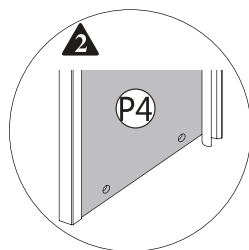
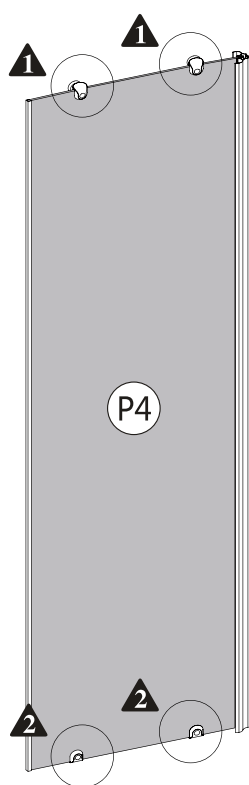
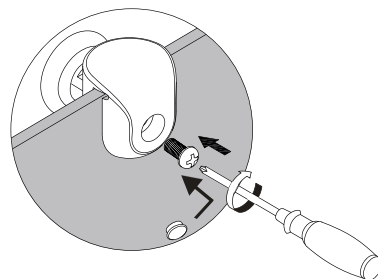
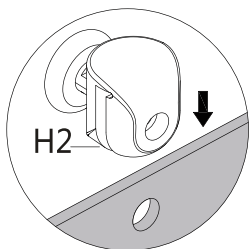
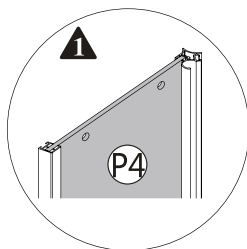



H2
x2



H3
x2

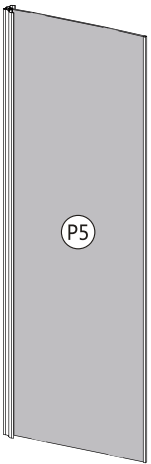

P5

P5

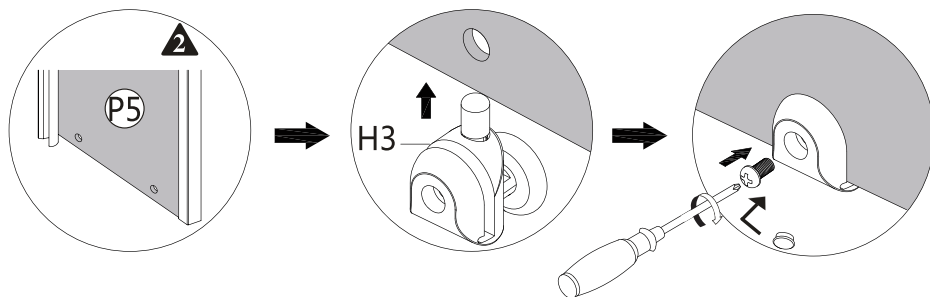
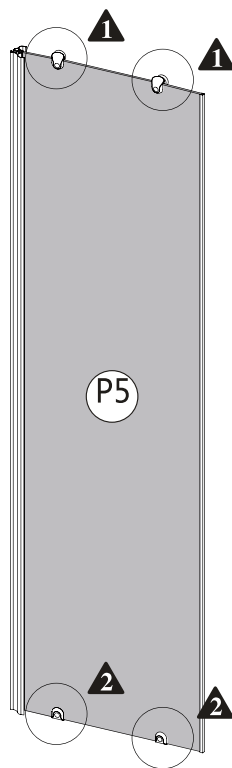
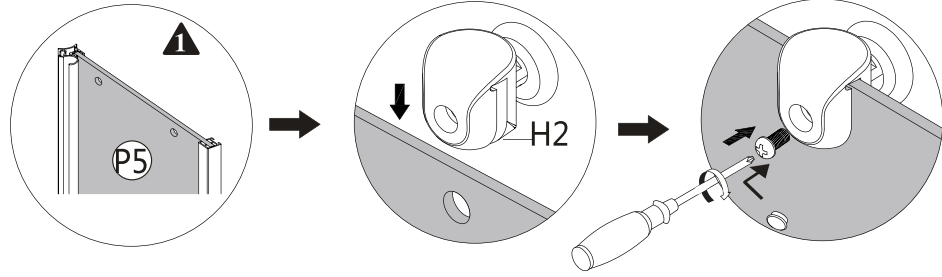

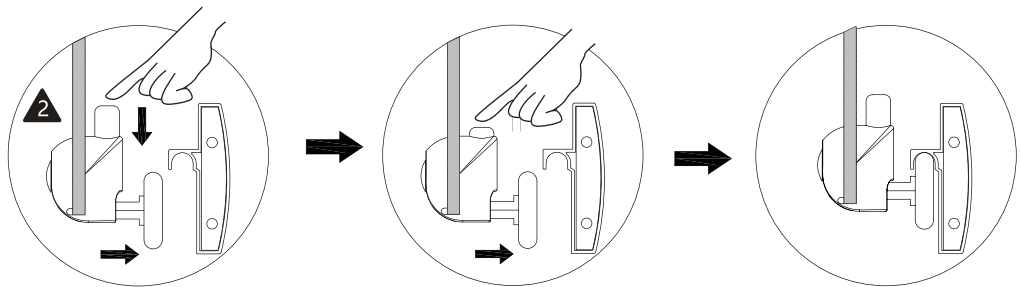
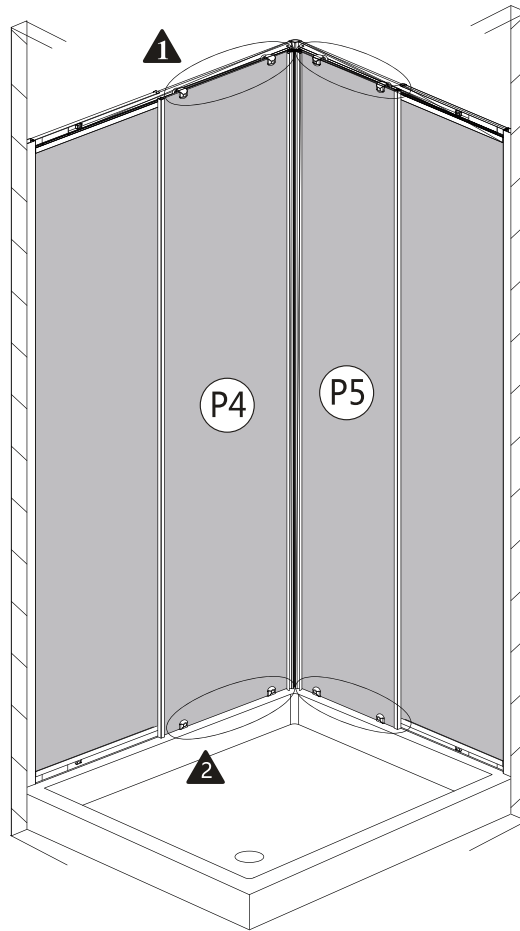
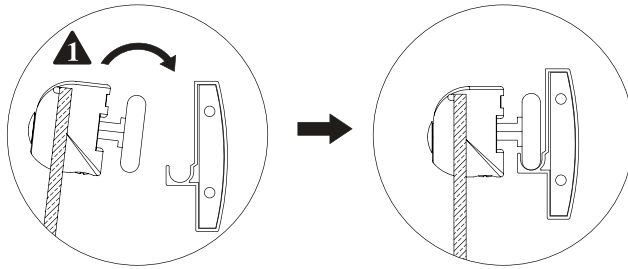

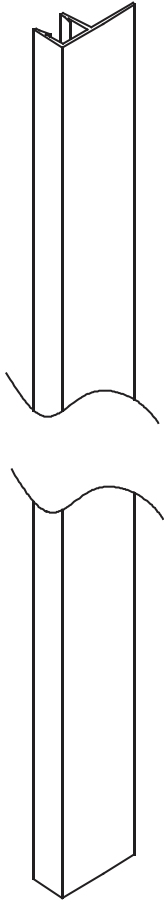

P11 X2

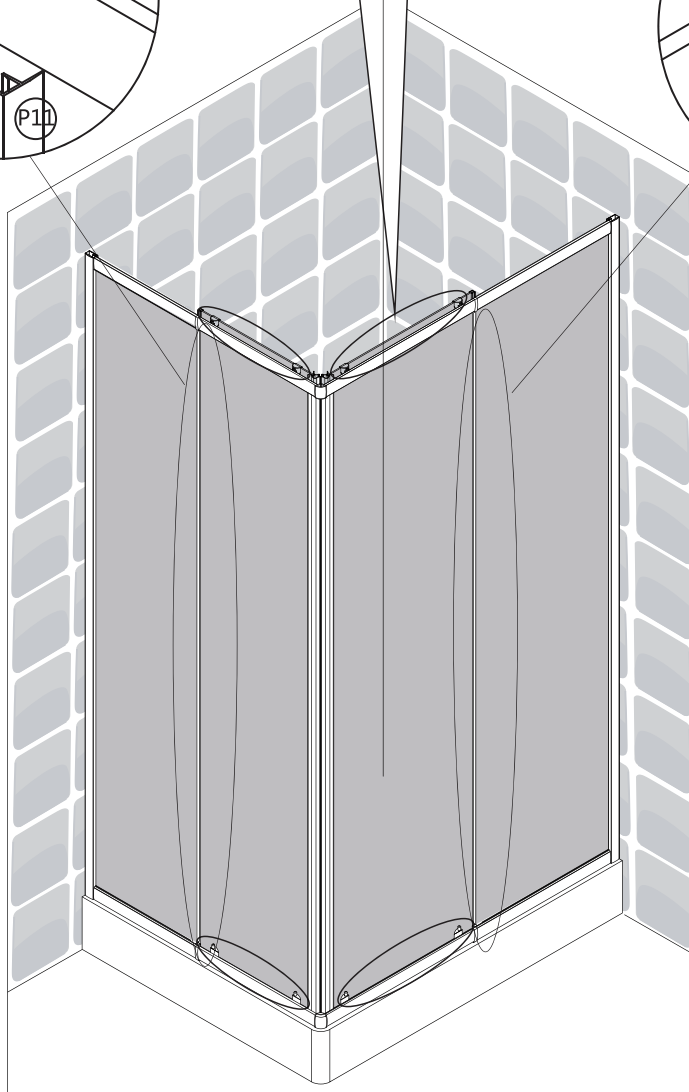
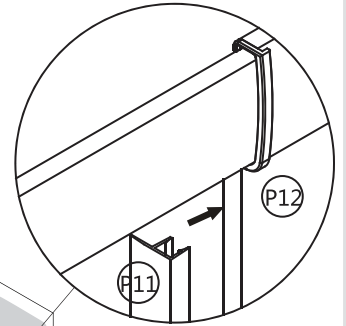
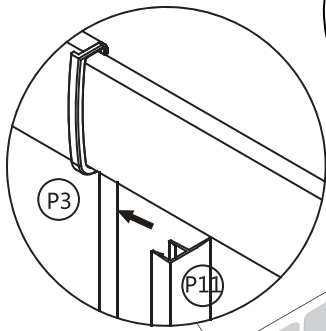
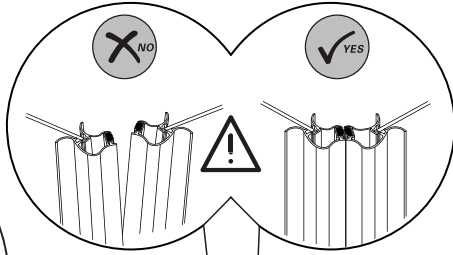
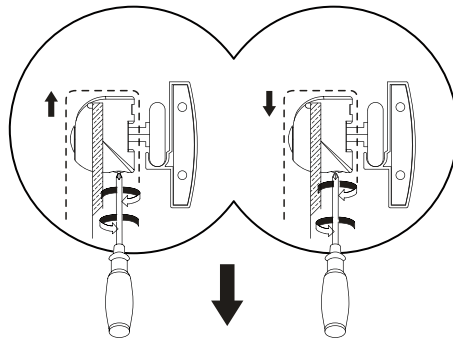



16

ESSENTIAL
(700-800) X (800-900) X 1850mm
(700-800) X (900-1000) X 1850mm

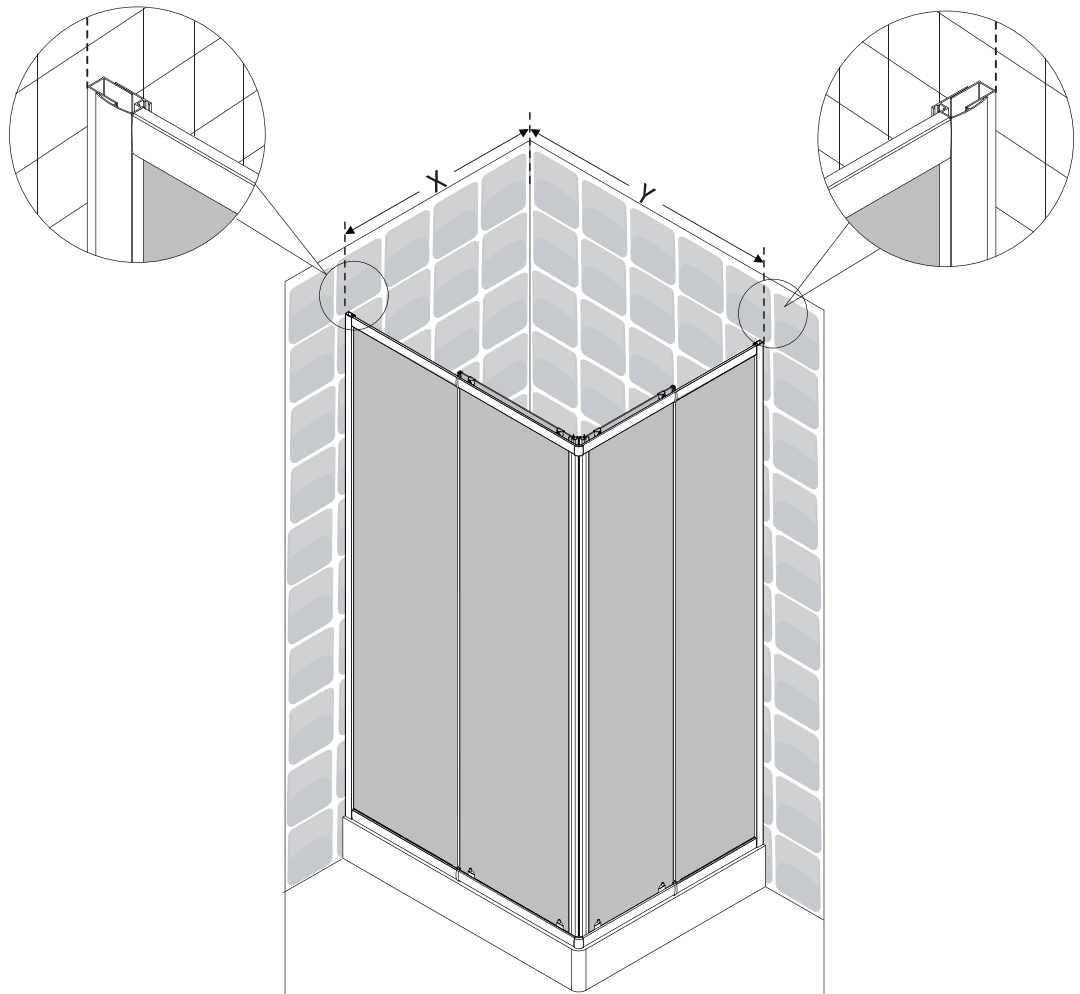
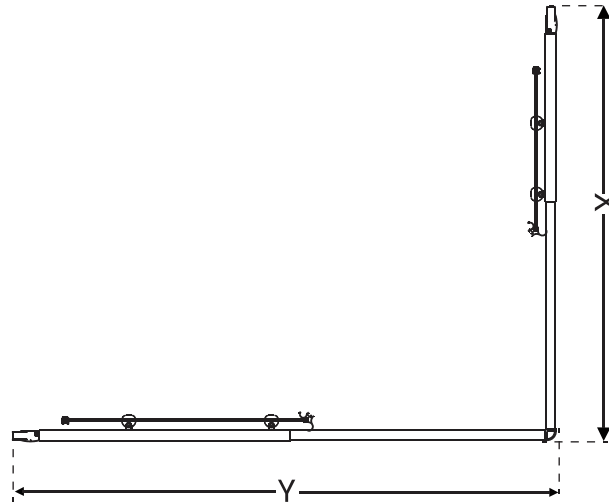



17

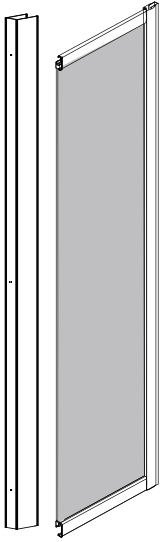

P2
x2

P3
x1

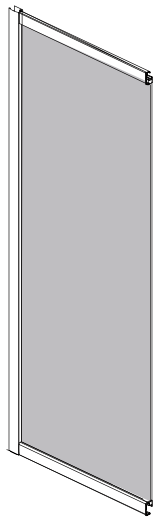

P12

x1

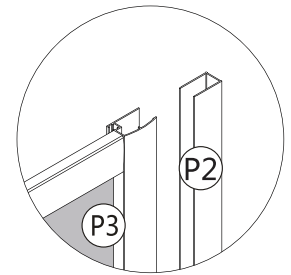
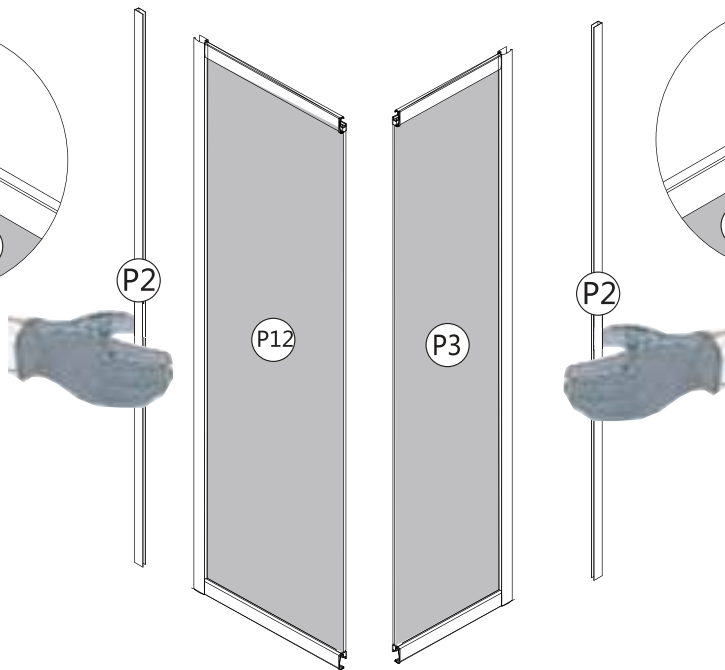
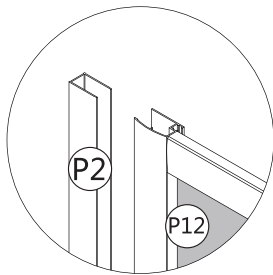
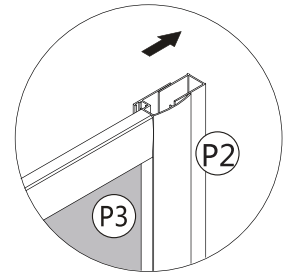
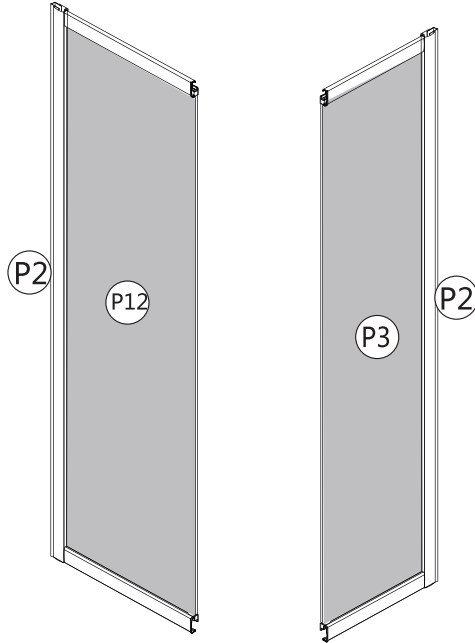
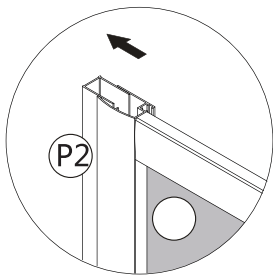

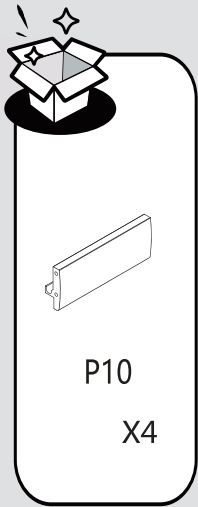

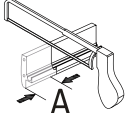
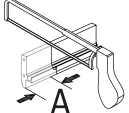
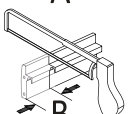
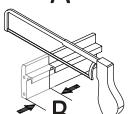
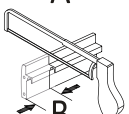
	EAN code	ESSENTIAL(mm)	A(mm)	B(mm)
	3276000664819	(700-800)X(800-900)	A=790-X	B=890-Y
	3276000664857	(700-800)X(800-900)	A=790-X	B=890-Y
	3276000664871	(700-800)X(900-1000)	A=790-X	B=990-Y
	3276000664864	(700-800)X(900-1000)	A=790-X	B=990-Y

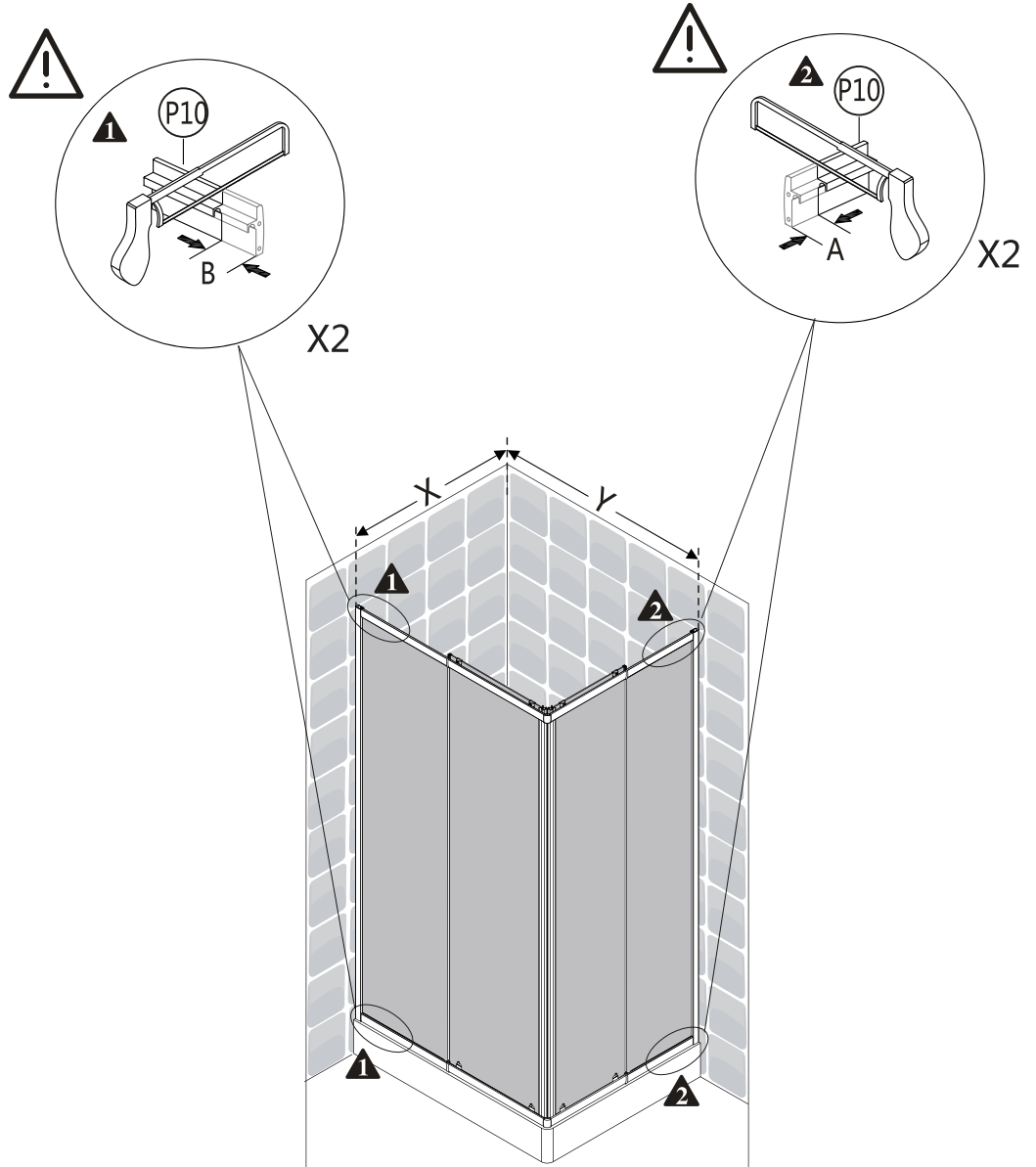

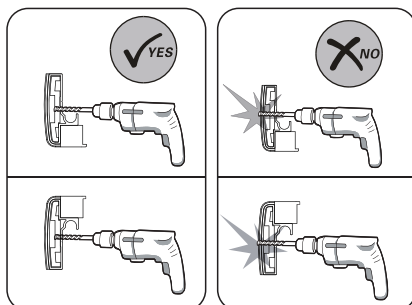
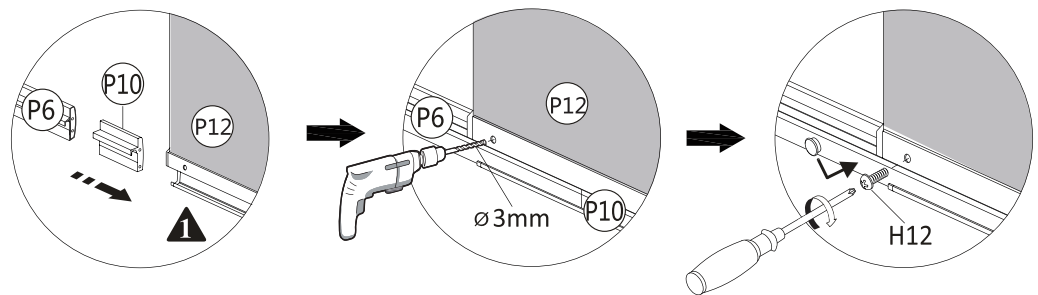
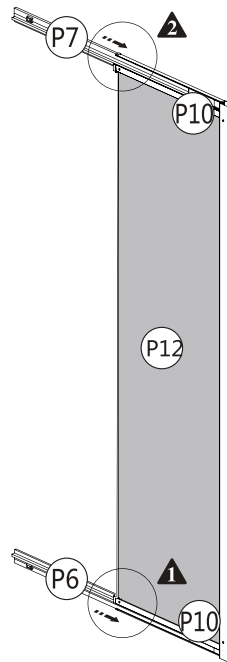
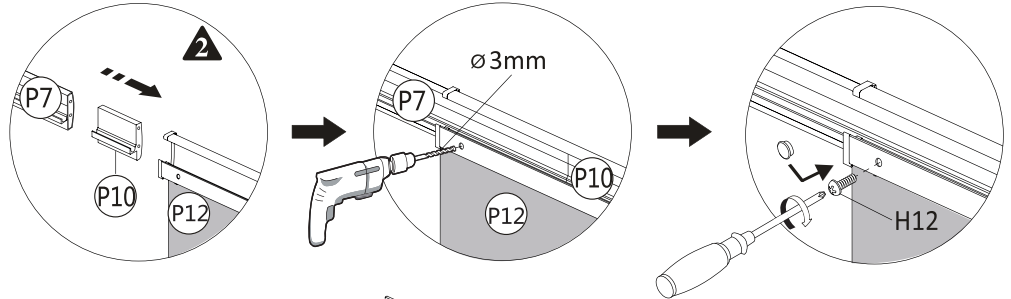
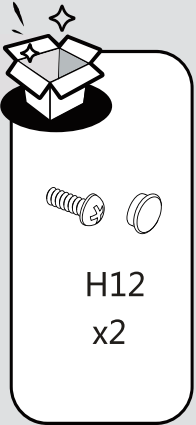

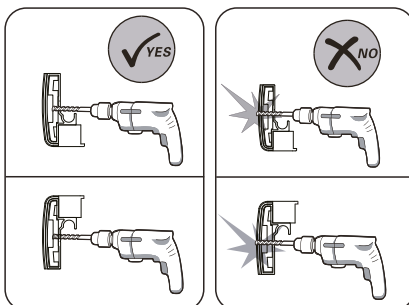
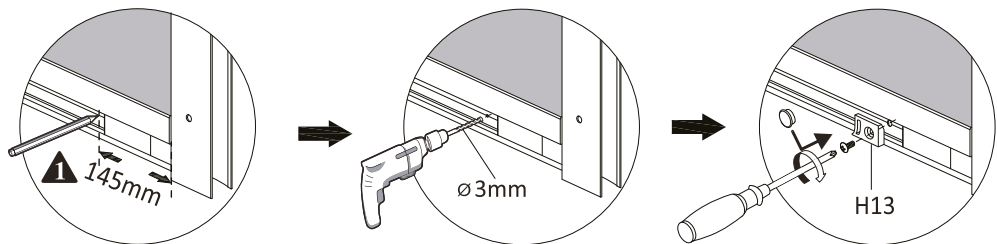
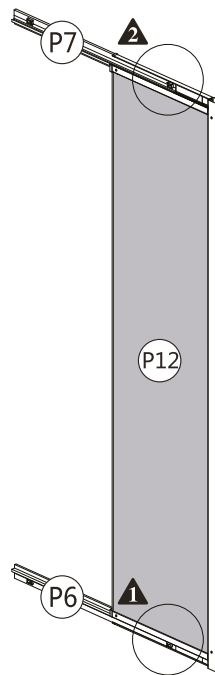
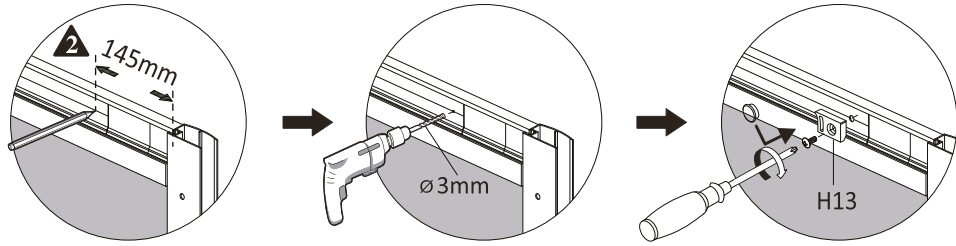
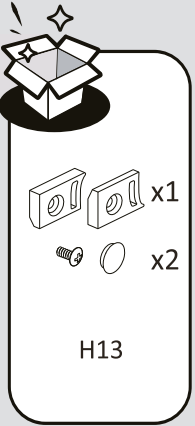

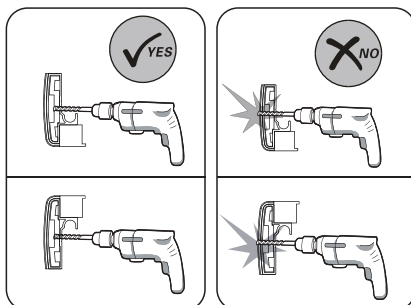
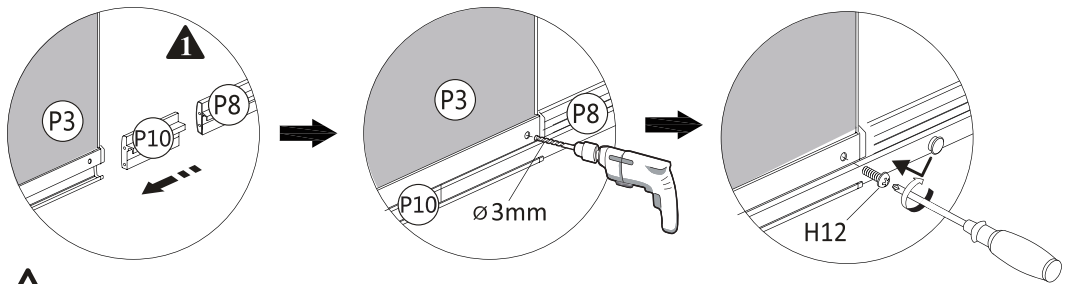
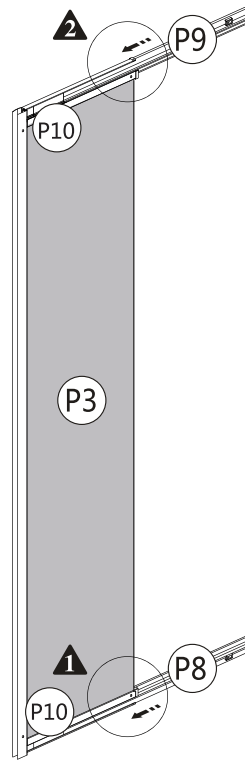
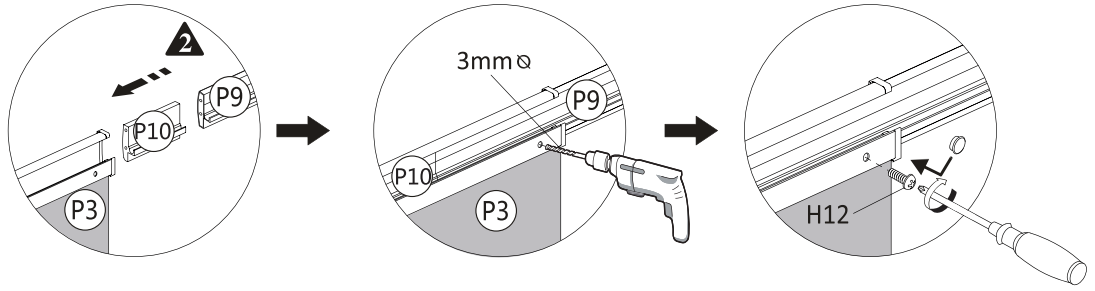
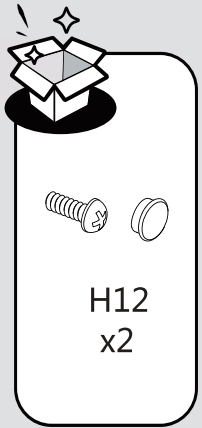

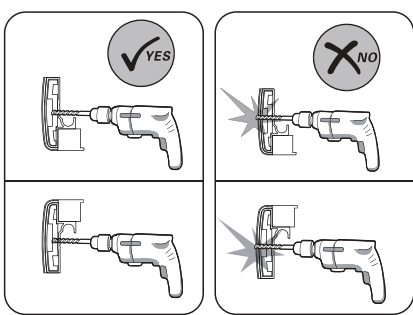
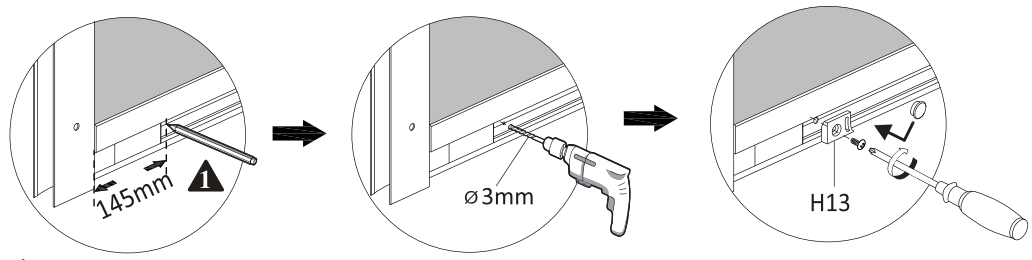
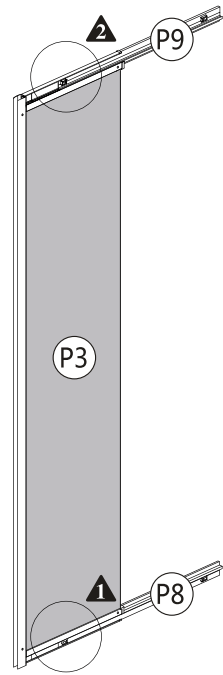
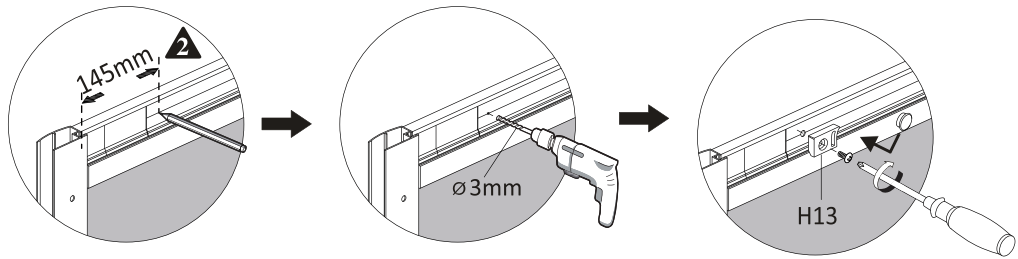
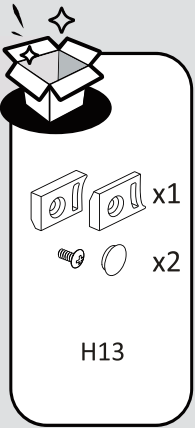

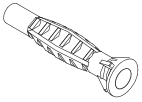

H4
x6



(P2)
X2

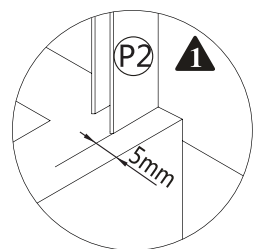
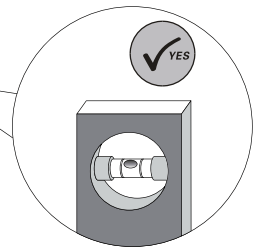
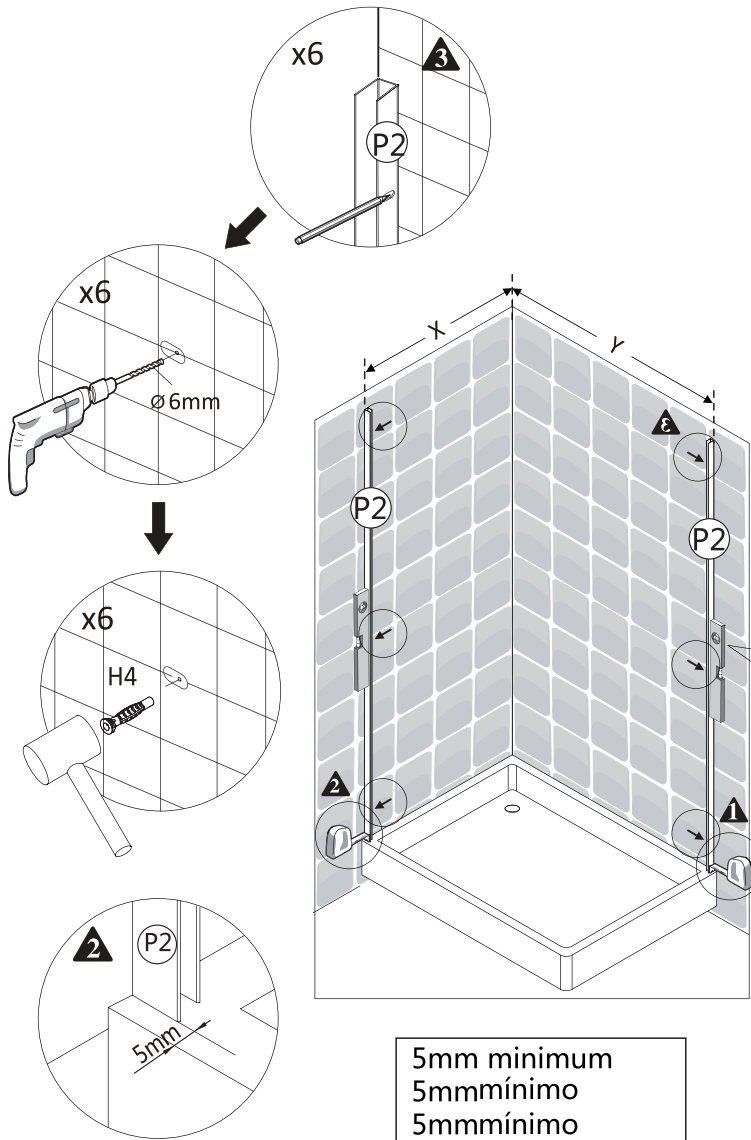
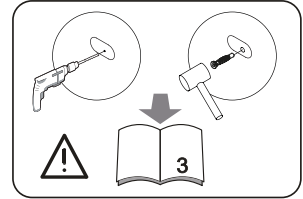

5mm minimum
 5mm mínimo
 5mm mínimo
 5mm mínimo
 5mmελάχιστο
 5mmminimalny
 5mmминимальный
 5mmминимум
 5mmмінімальний
 5mmminim
 5mm mínimo
 5mm minimum

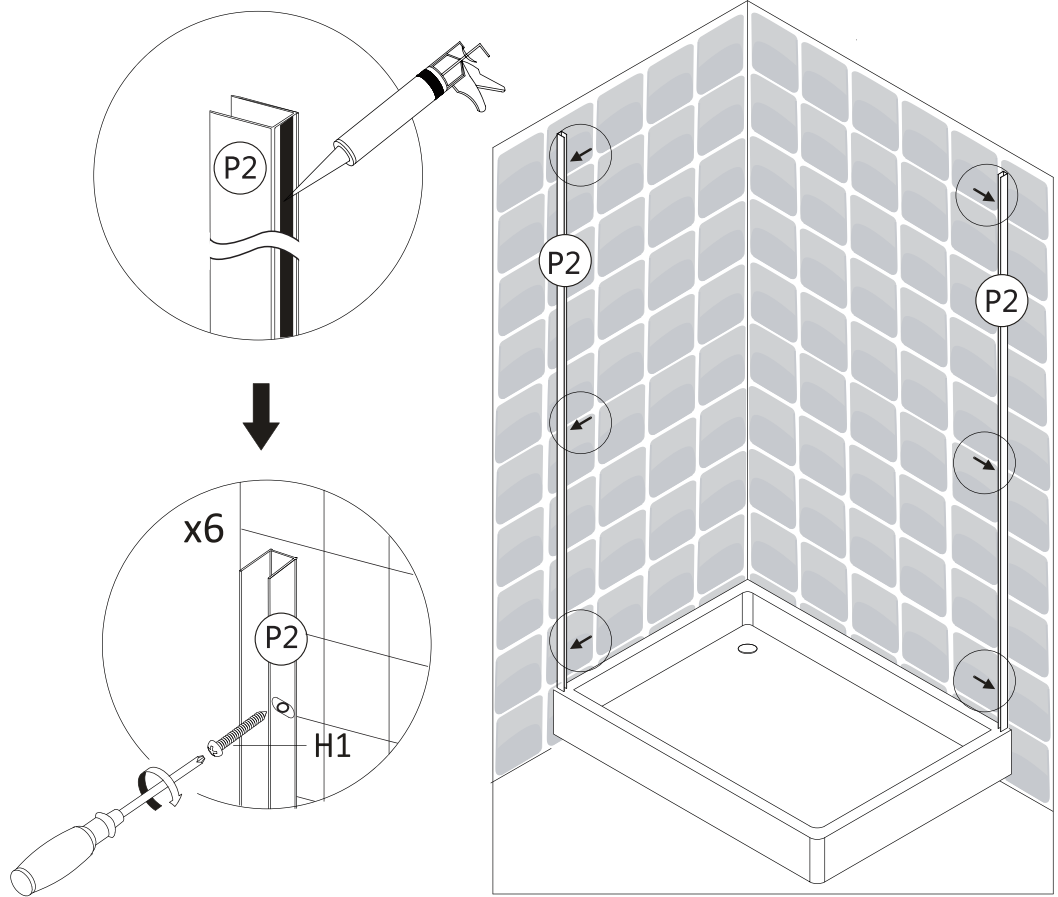
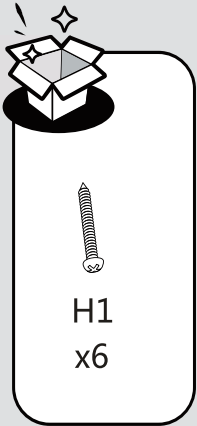

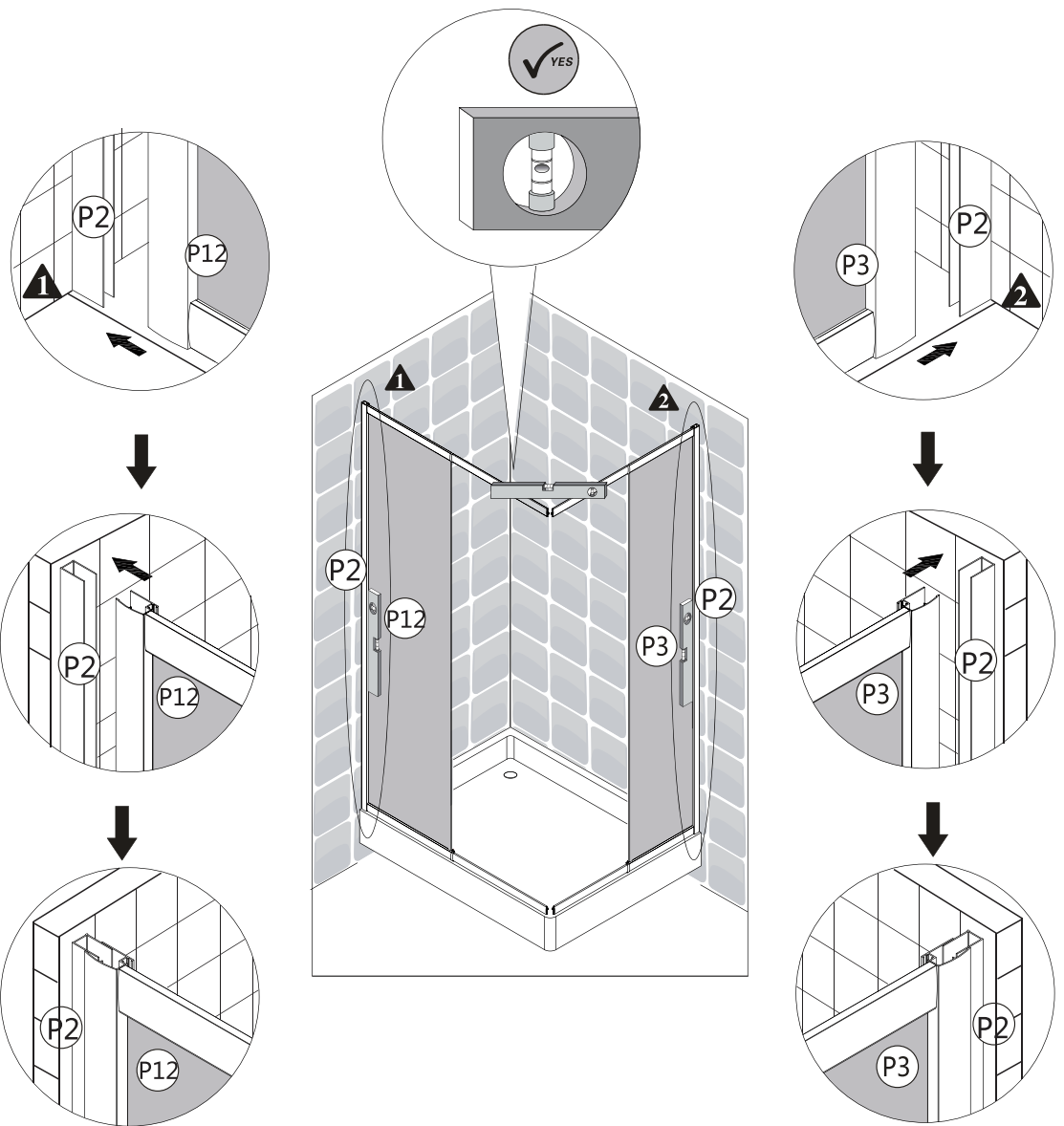





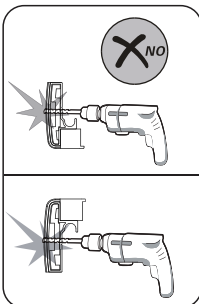
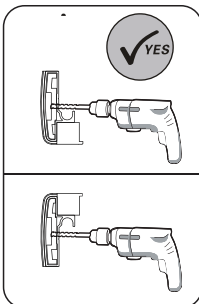
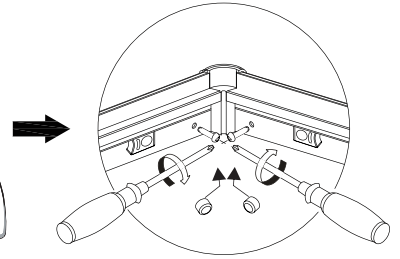
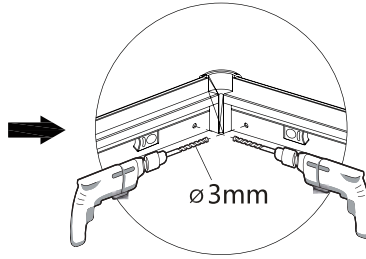
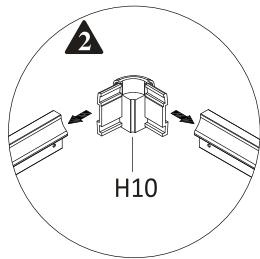
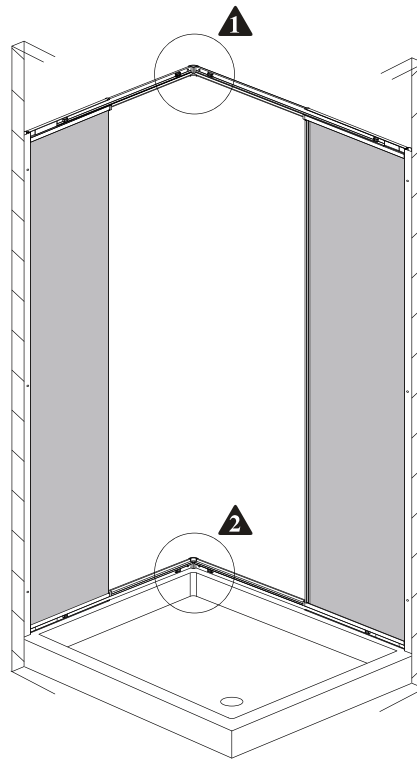
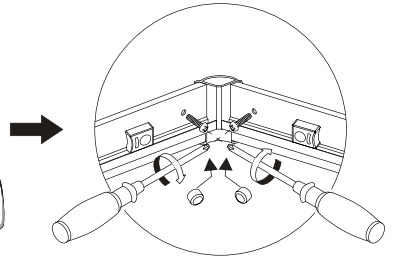
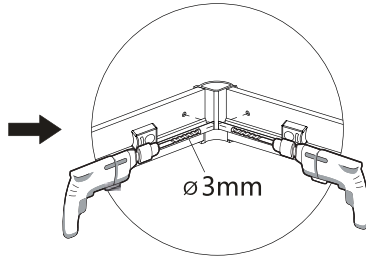
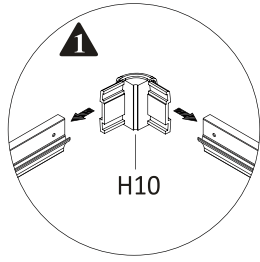

x2
x4
H10





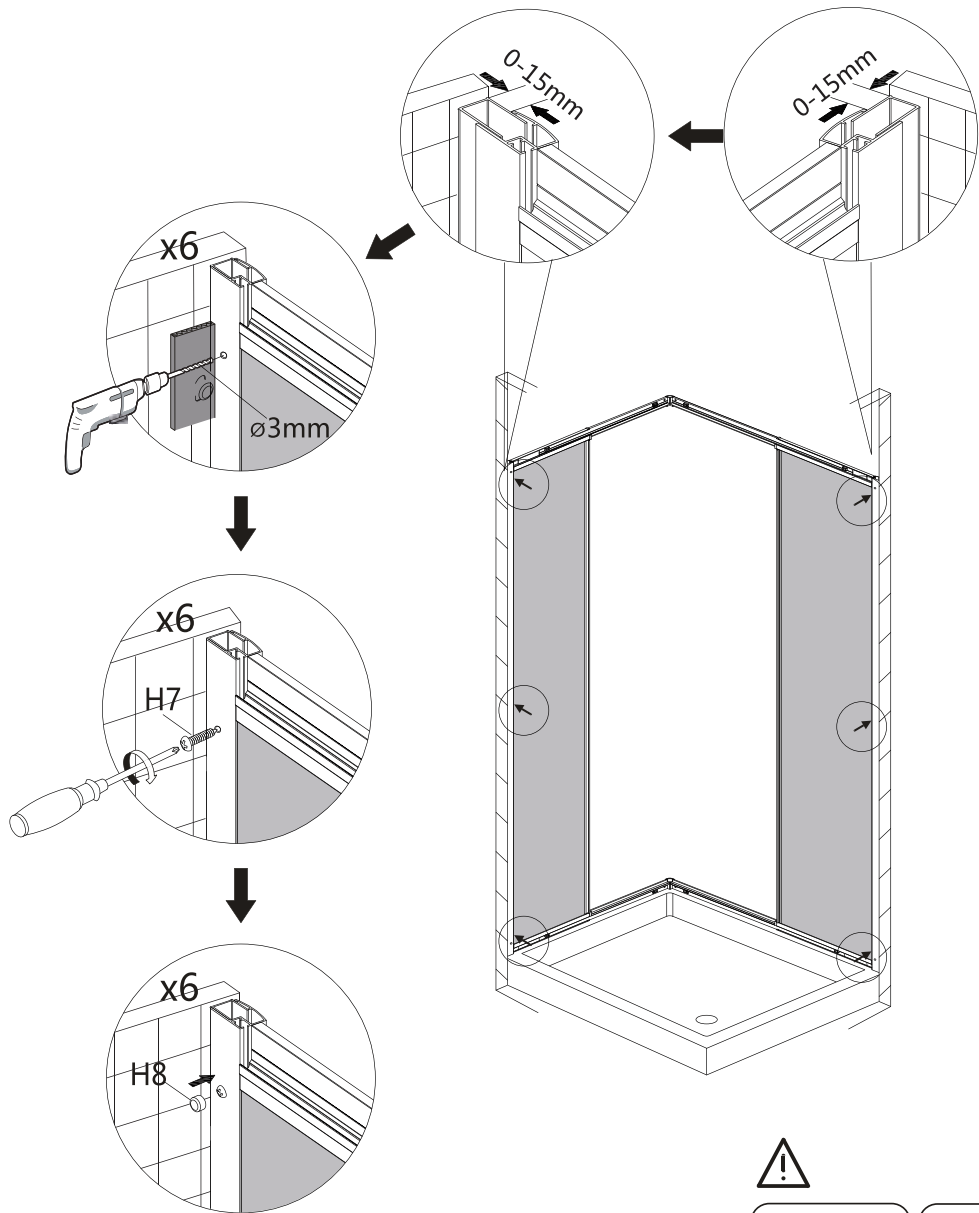



 
 H7 H8
 x6 x6

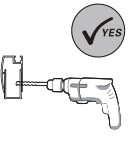
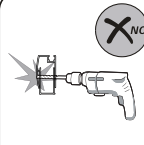

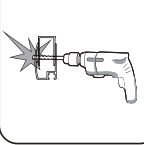

	
	



H2
x2



H3
x2

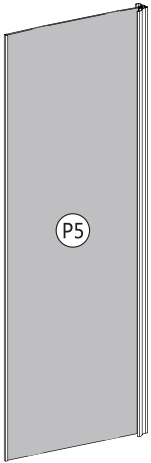

P5

P5

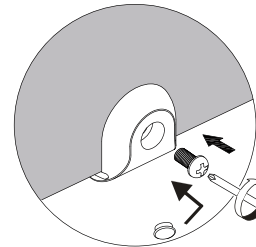
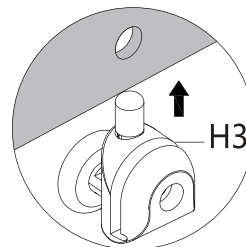
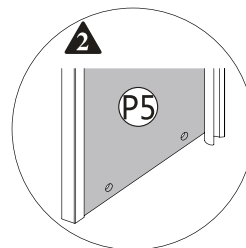
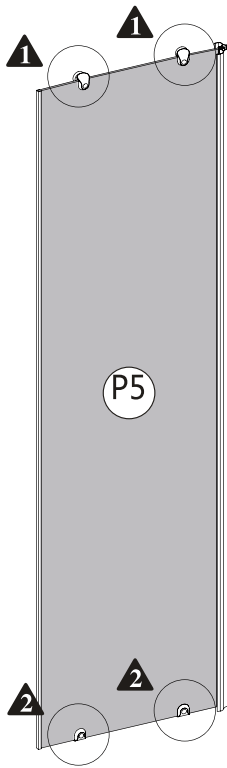
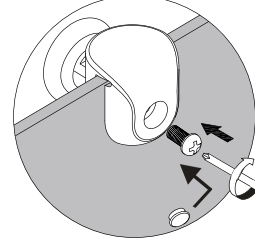
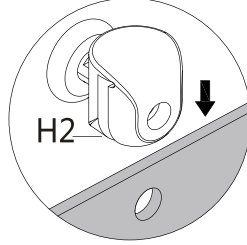
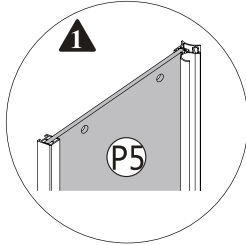



H2
x2

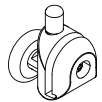

H3
x2

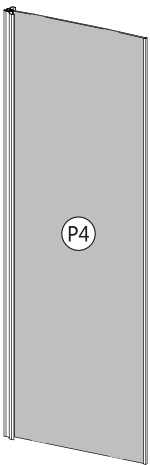

P4

P4

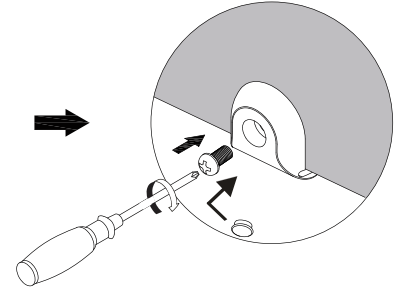
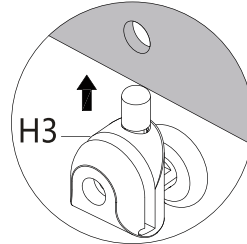
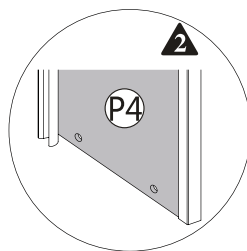
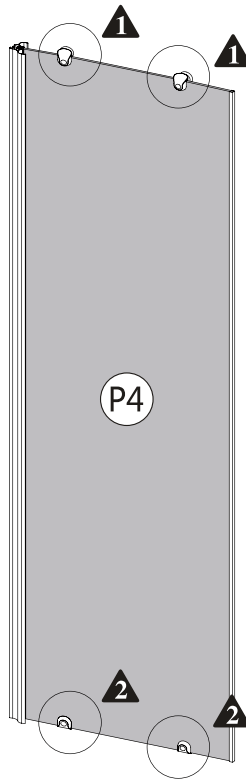
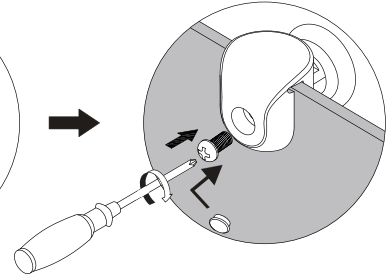
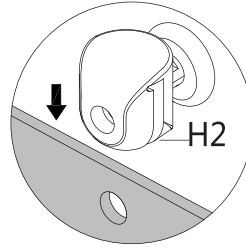
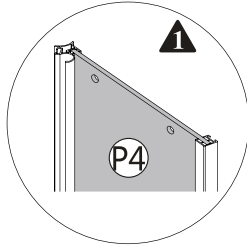

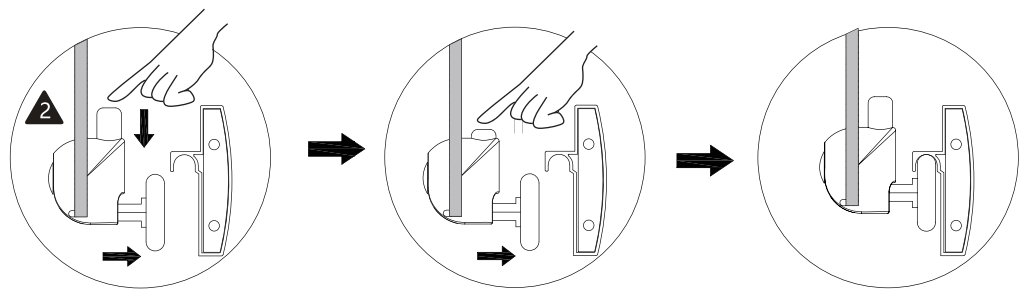
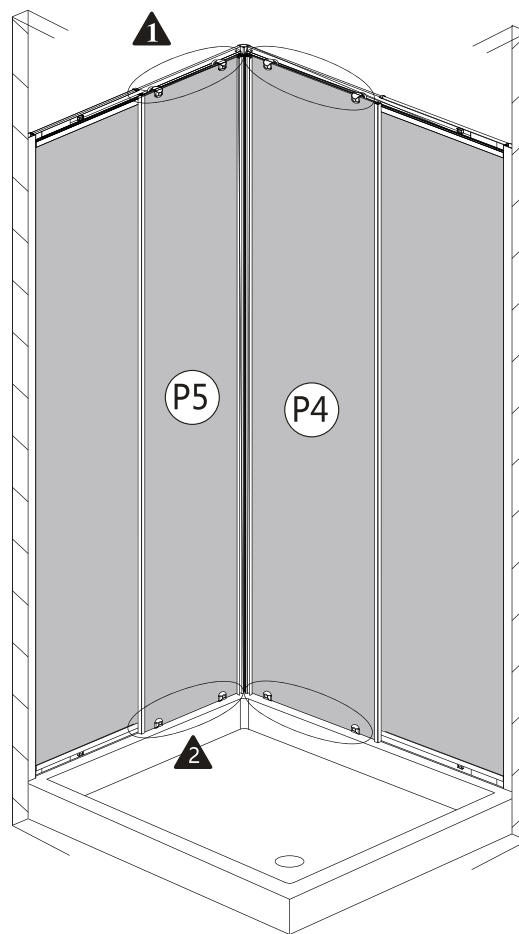
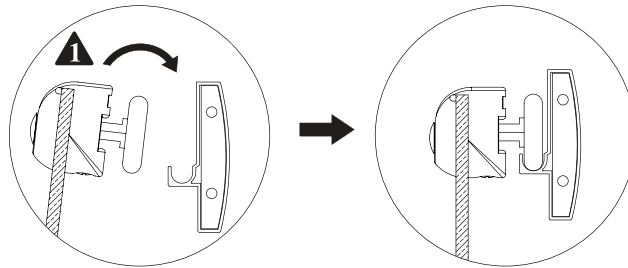

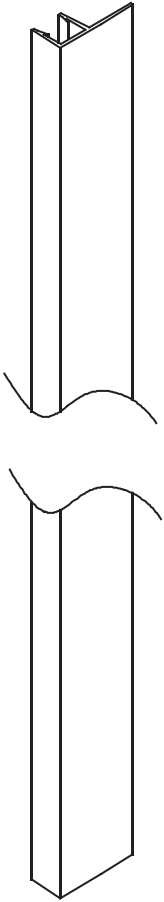

P11 X2

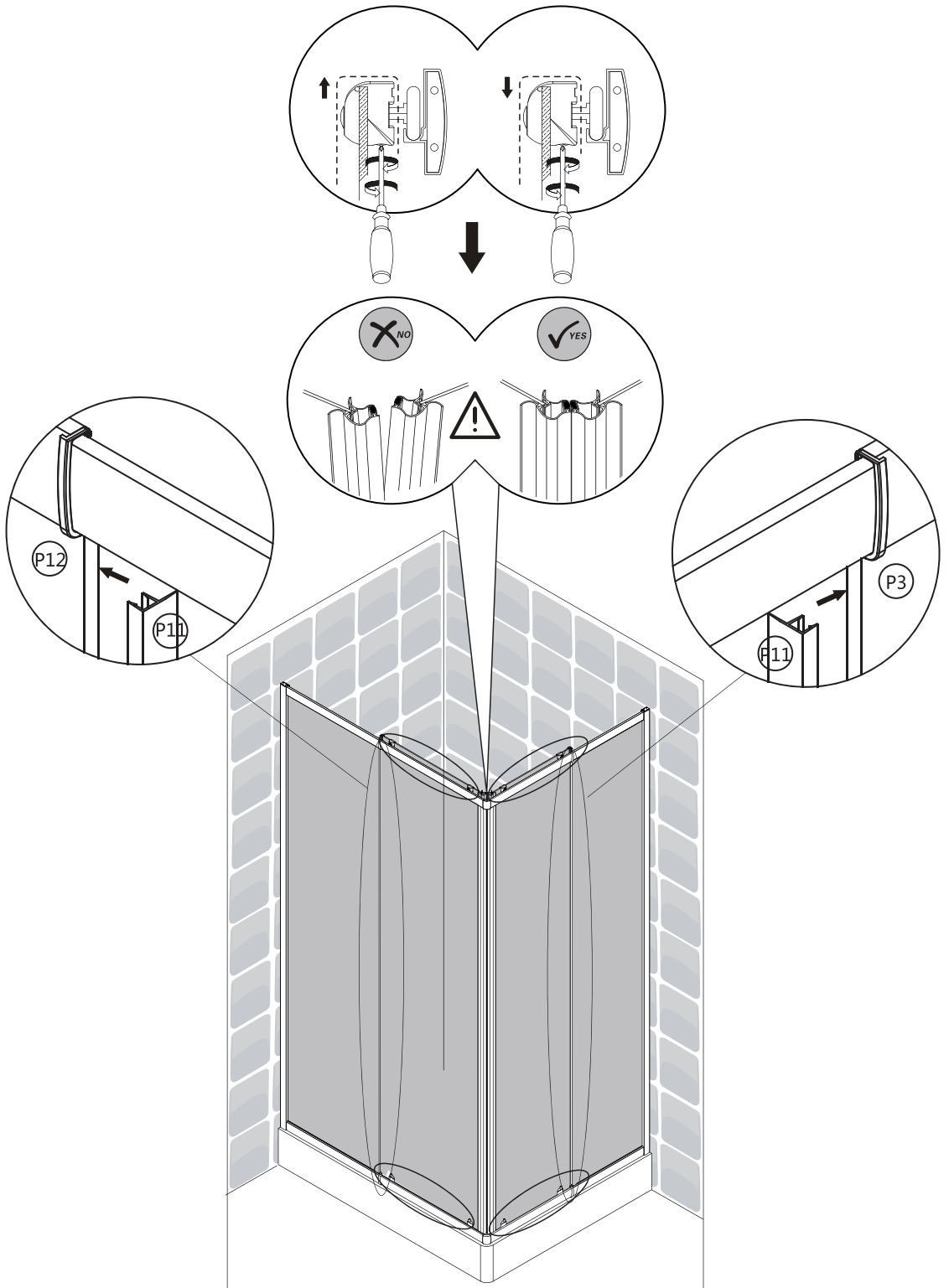

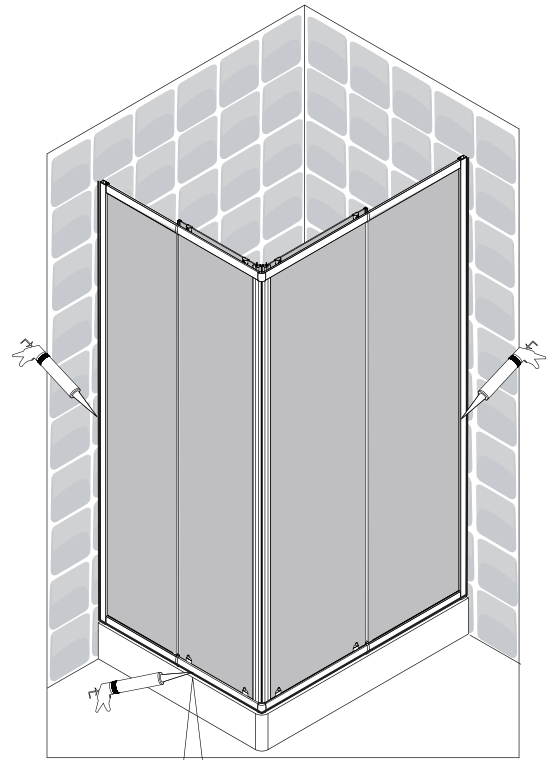
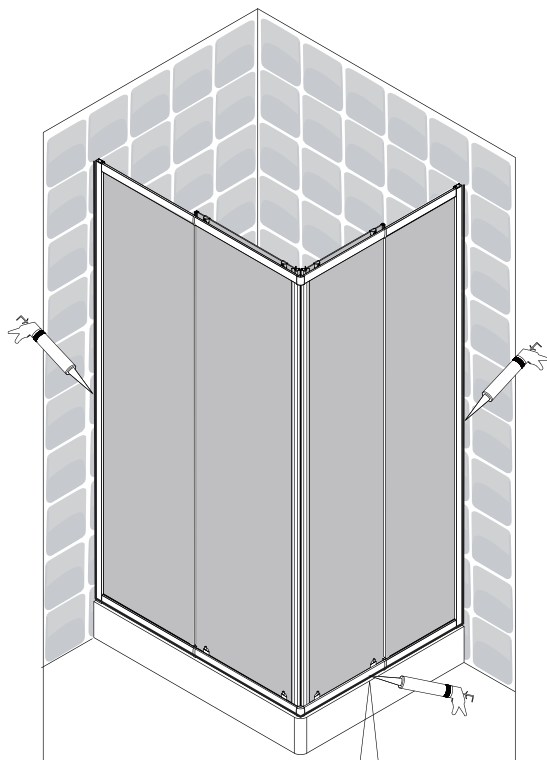
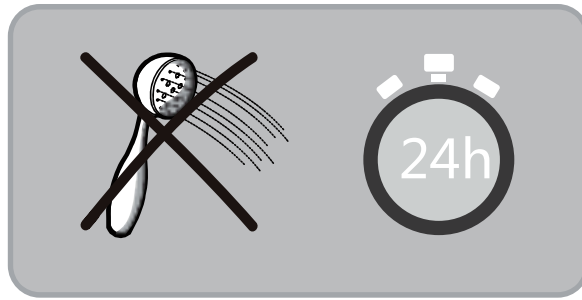





Eau claire / Agua limpia / Água limpa / Acqua pulita / Καθαρό νερό / Czysta woda / Чистая вода / Água limpa /
Чиста вода / Ara curata / таза су / Clean water

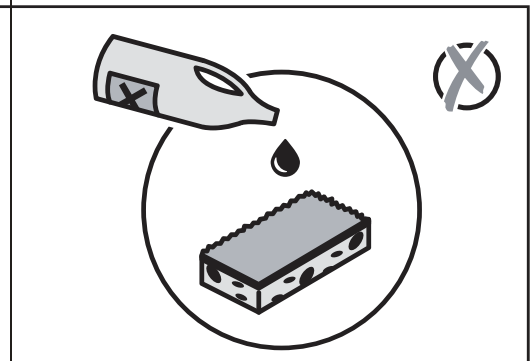
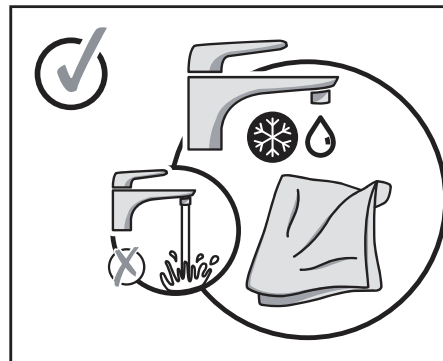
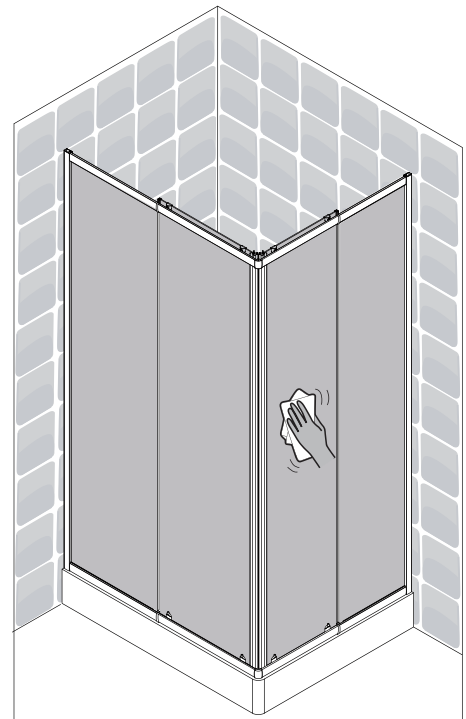
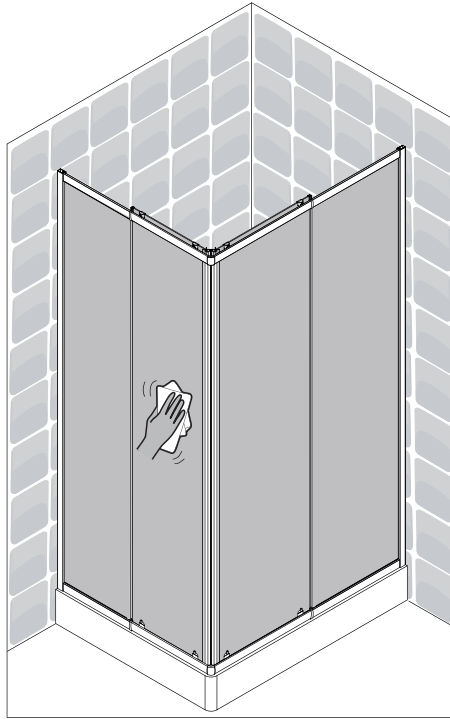

Sans solvant / Sin disolvente / Sem solventes / Senza solventi / Χωρίς διαλυτικά / Bez rozpuszczalnika / Без растворителя /
Sem solventes/ Без розчинника / Fara solvent / еріткішсіз / Solvent-free



FR 

ADEO Services -135 Rue Sadi Carnot -
CS 00001 59790 RONCHIN - France
19
EN 14428: 2015+A1: 2018

Code d'identification unique
du produit type: **
usage prévu: hygiène personnelle
Nettoyable: Conforme
Résistance à l'impact/
Capacité de Fragmentation: Conforme
durabilité: Conforme

DOPN° 207919/0001/2019

ES 

ADEO Services -135 Rue Sadi Carnot -
CS 00001 59790 RONCHIN - France
19
EN 14428: 2015+A1: 2018

Código de identificación
única del producto tipo: **
Uso previsto: higiene personal
Limpiable: Conforme
Resistencia al impacto/
Capacidad de fragmentación: Conforme
Durabilidad: Conforme

DOPN° 207919/0001/2019

PT 

ADEO Services -135 Rue Sadi Carnot -
CS 00001 59790 RONCHIN - France
19
EN 14428: 2015+A1: 2018

Código de identificação
único do produto-tipo: **
Utilização prevista: higiene pessoal
Limpeza: Conforme
Resistência ao impacto/
Capacidade de fragmentação: Conforme
Durabilidade: Conforme

DOPN° 207919/0001/2019

IT 

ADEO Services -135 Rue Sadi Carnot -
CS 00001 59790 RONCHIN - France
19
EN 14428: 2015+A1: 2018

Codice di identificazione
unico del prodotto-tipo: **
Uso previsto: igiene personale
Pulibile: Conforme
Resistenza agli urti/
Capacità di Frammentazione: Conforme
Durata: Conforme

DOPN° 207919/0001/2019

EL 

ADEO Services -135 Rue Sadi Carnot -
CS 00001 59790 RONCHIN - France
19
EN 14428: 2015+A1: 2018

Μοναδικός κωδικός ταυτοποίησης
του τύπου του προϊόντος: **
προβλεπόμενη χρήση: προσωπική υγιεινή
Δυνατότητα καθαρισμού: Σύμφωνα με
Αντοχή σε κρούση/
Ικανότητα κατάτμησης: Σύμφωνα με
Διάρκεια: Σύμφωνα με

DOPN° 207919/0001/2019

PL 

ADEO Services -135 Rue Sadi Carnot -
CS 00001 59790 RONCHIN - France
19
EN 14428: 2015+A1: 2018

Niepowtarzalny kod
identyfikacyjny typu wyrobu: **
przeznaczenie: higiena osobista
Możliwość czyszczenia: Zgodny
Odporność na uderzenia/
Rozkruszalność: Zgodny
Trwałość: Zgodny

DOPN° 207919/0001/2019

RU 

ADEO Services -135 Rue Sadi Carnot -
CS 00001 59790 RONCHIN - France
19
EN 14428: 2015+A1: 2018

Уникальный идентификационный
код типа изделия: **
Назначение: личная гигиена
Легкость очистки: Соответствие
Ударопрочность/
Мощность распыления: Соответствие
Долговечность: Соответствие

DOPN° 207919/0001/2019

UK 

ADEO Services -135 Rue Sadi Carnot -
CS 00001 59790 RONCHIN - France
19
EN 14428: 2015+A1: 2018

Унікальний ідентифікаційний
код виду продукції: **
призначення: особиста гігієна
Легкість очищення: Відповідність
Ударостійкість/
Потужність розпилення: Відповідність
Довговічність: Відповідність

DOPN° 207919/0001/2019

RO 

ADEO Services -135 Rue Sadi Carnot -
CS 00001 59790 RONCHIN - France
19
EN 14428: 2015+A1: 2018

Cod unic de identificare
a tipului de produs: **
destinație: igienă personală
Posibilitatea de curățare: Conform
Rezistență la impact/
Capacitate de fragmentare: Conform
Durabilitate: Conform

DOPN° 207919/0001/2019

EN 

ADEO Services -135 Rue Sadi Carnot -
CS 00001 59790 RONCHIN - France
19
EN 14428: 2015+A1: 2018

Unique identification code
of the product-type: **
Intended use: personal hygiene
cleanability: Pass
Impact resistance/ shatter properties: Pass
Durability: Pass

DOPN° 207919/0001/2019

**

FR Reportez-vous à l'annexe.

ES Consulte el apéndice.

PT Consulte o anexo.

IT Consultare l'appendice.

EL Ανατρέξτε στο Παράρτημα.

PL Patrz załącznik.

RU См. приложение.

UK Читайте додаток.

RO Consultați anexa.

EN Refer to appendix.



* Garantie 3 ans / 3 años de garantía / Garantia de 3 anos / Garanzia 3 Anni / Εγγύηση 3 ετών /
Gwarancja 3-letnia / Гарантия 3 года / Кепілдік 3 жыл / Гарантія 3 років / Garanție 3 ani /
Garantia de 3 anos/ 3-year guarantee



Made in P.R.C. 2019

ADEO Services - 135 Rue Sadi Carnot - CS 00001
59790 RONCHIN - France

ТОВ «Леруа Мерлен Україна»,
вул. Полярна 17а, м. Київ 04201, Україна

LM - 18B, Building 4,2 Dajiaoting Zhongjie, Chaoyang District,
Beijing 100022 - CHINA, P.R.C

ООО ЛЕРУА МЕРЛЕН ВОСТОК, 141031, Московская
область, Мытищинский район, г. Мытищи,
Осташковское шоссе, д.1, РОССИЯ

Importado e distribuído por LEROY MERLIN
CIA BRASILEIRA DE BRICOLAGEM
Rua Domingas Galleteri Blotta, 315 - Interlagos - CEP
04455-360 São Paulo - SP - Brazil CNPJ: 01.438.784/0001-05
CALM (Central de Atendimento Leroy Merlin) -4020.5376 (capitais)
e 0800.0205376 (demais regiões)

Imported by Adeo South Africa (PTY) LTD T/A Leroy Merlin
Leroy Merlin Greenstone Store - Corner Blackrock Street
and Stoneridge Drive, Greenstone Park Ext 2,
Edenvale, 1610 - Johannesburg, Gauteng, South Africa

«Леруа Мерлен Казахстан» ЖШС Қазақстан
Республикасы, 050000, Алматы қ., Қонаев
көшесі, 77, «ParkView» БО, бқ, 07 оф.

