

CLASSIC

Studio expormim

**Sillón “Modena” / armchair**

C051

*OUT*



Colección fabricada en tubo de aluminio de alta resistencia y tejida a mano artesanalmente con fibra sintética redonda (3 mm de sección) de polietileno de alta densidad (HDPE).

Collection made of high resistance aluminium tube and hand-woven synthetic round fibre (3 mm width) of high density polyethylene (HDPE).

<b>Medidas / Dimensions</b>	106 x 100 x 80 cm 41.75" x 39.25" x 31.5"
<b>Peso / Weight</b>	19 kg / 41.9 lb
<b>Volumen / Volume</b>	0,85 m <sup>3</sup> / 30.02 ft <sup>3</sup>

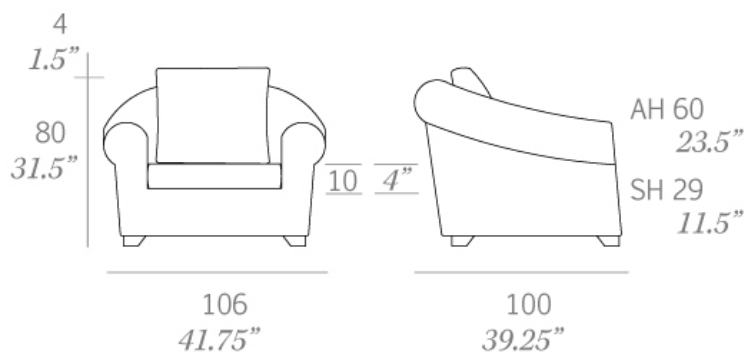



084 honey

**Serie 2 - Confección / cushions**

Duo Outdoor



Duo 54

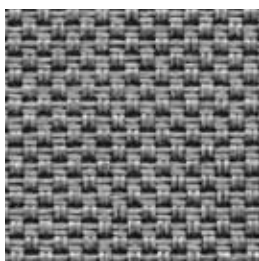

Duo 51



Duo 14

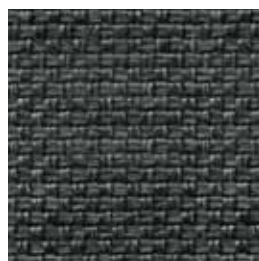

Duo 53



Duo 55



Duo 01

**Serie 1 - Confección / cushions**

Tempotest®



Marine C



Marine BG



Marine GC

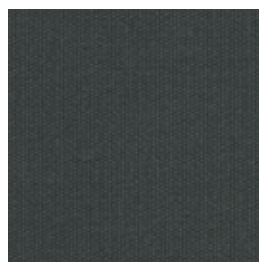

Marine G



Marine GN



Marine M

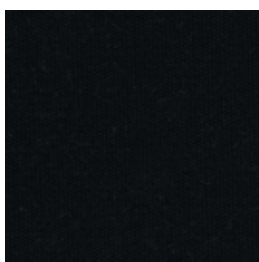

Marine NE



Marine MO



Marine A



Marine VN

**Serie 2 - Confección**



Marivent 23

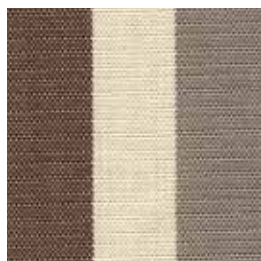

Marivent 40



Marivent 42



Marivent 44



Marivent 24



Marivent 41



Marivent 43

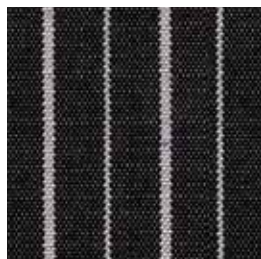

Marivent 45