

Equal High Pressure (mains) Installation:

Install mixer as supplied

Unequal Pressure and Equal Low Pressure Installation:

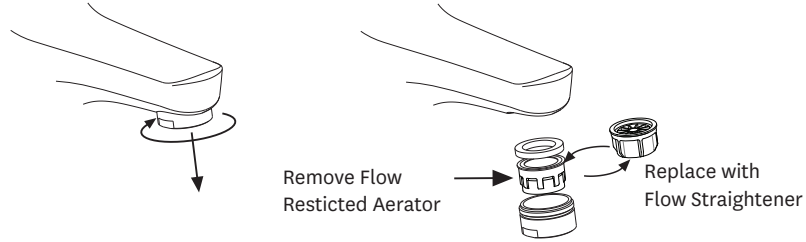

Unequal Pressure Installation:

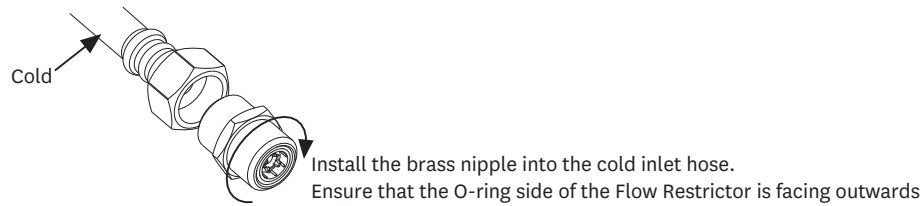

Ceramic Cartridge Adjustment:

Remove the handle from the mixer for ceramic cartridge adjustment.

Do not remove the ceramic cartridge from the mixer while carrying out the following adjustments.

NOTE: The Cartridge is set for maximum temperature.

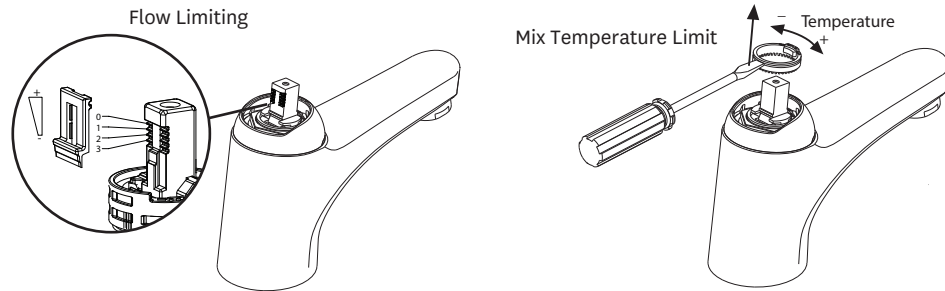

Methven warrants this product against manufacturing defects and that it is suitable for use under the general operating conditions specified in this instruction sheet. However, regional regulations apply and may affect your warranty. Please refer to www.methven.com or call customer service for full details.

New Zealand
0800 804 222

Australia
1300 638 483

UK
0800 195 1602

439901

ISSUE A

Basin Mixer (All Pressure) Installation Guide

Technical Specifications:

Operating Pressure:

Min: 35kPa/0.35bar

Max: 1000kPa/10bar*

Optimum: 150kPa/1.5bar - 500kPa/5bar

Install a NEFA PLV if supply pressure exceeds 1000kPa/10bar.

Operating Temperature:

Hot: Max 80°C*

Cold: Min 5°C

Inlet Connections:

All ½" BSP

* Regional specific regulations apply.

Please refer to your warranty statement at

www.methven.com

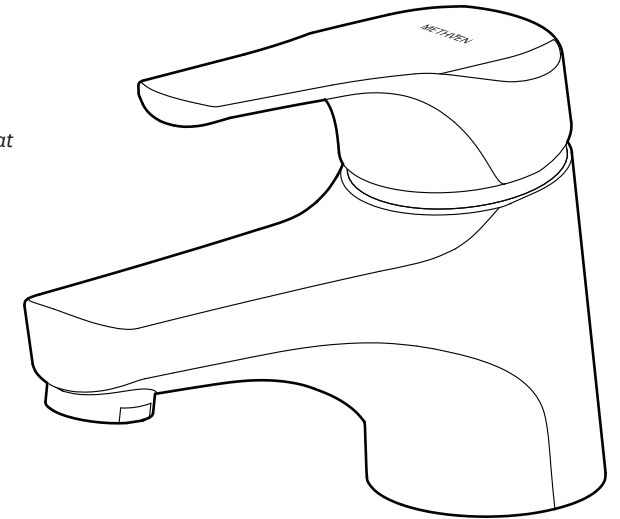

METHVEN
www.methven.com

IMPORTANT: Please read all of the instructions before installation.

General:

- This mixer is designed for equal and unequal pressure systems
- Methven recommends this product is installed by a licensed plumber in compliance with all relevant regional regulations.
- Do not hydrostatic test the installation with this mixer installed. Damage to the ceramic cartridge may occur.
- All pipe work must be thoroughly flushed prior to the installation of the mixer.
- In-line filters must be fitted on both hot and cold supplies to prevent foreign particles damaging the ceramic cartridge.
- Do not remove the ceramic cartridge from the mixer when installing.
- After installation all connections must be checked for leaks.
- All outlets used primarily for personal hygiene shall deliver water at a safe temperature as per regional regulations.
- This mixer is not recommended for use in uncontrolled heating systems such as wet-backs or solar heating units unless a suitable tempering valve is fitted.
- If limited water flow is experienced, locate aerator and filter washers and clean away foreign material as required.
- It is the responsibility of the installer to ensure a waterproof seal is achieved between the product and mounting surface. If in doubt about the quality of the seal, remove the product and reinstall using silicone to ensure a seal is achieved.

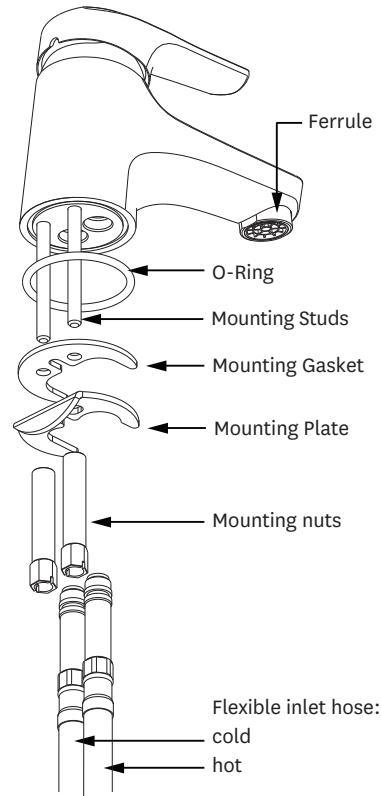

Installation:

Tip: Install product to mounting surface before connecting second hose to mixer.

1. Cut a single hole minimum 35mm/maximum 38mm diameter into the mounting surface.
2. Screw the mounting studs into the bottom of the basin mixer, and connect one flexible hose to the mixer. Insert o-ring into the groove in the bottom of the mixer.
3. Feed the mixer's hose and mounting studs through the hole cut in the mounting surface, and position the mixer where required.
4. Fit the mounting gasket, mounting plate and mounting nuts onto the mounting studs. Tighten in place from under the mounting surface.
5. Insert the remaining flexible hose through the hole in the mounting surface (from the underside) and screw it into the base of the mixer.
6. Connect the flexible hoses to the hot and cold supplies (hot on the left, cold on the right).

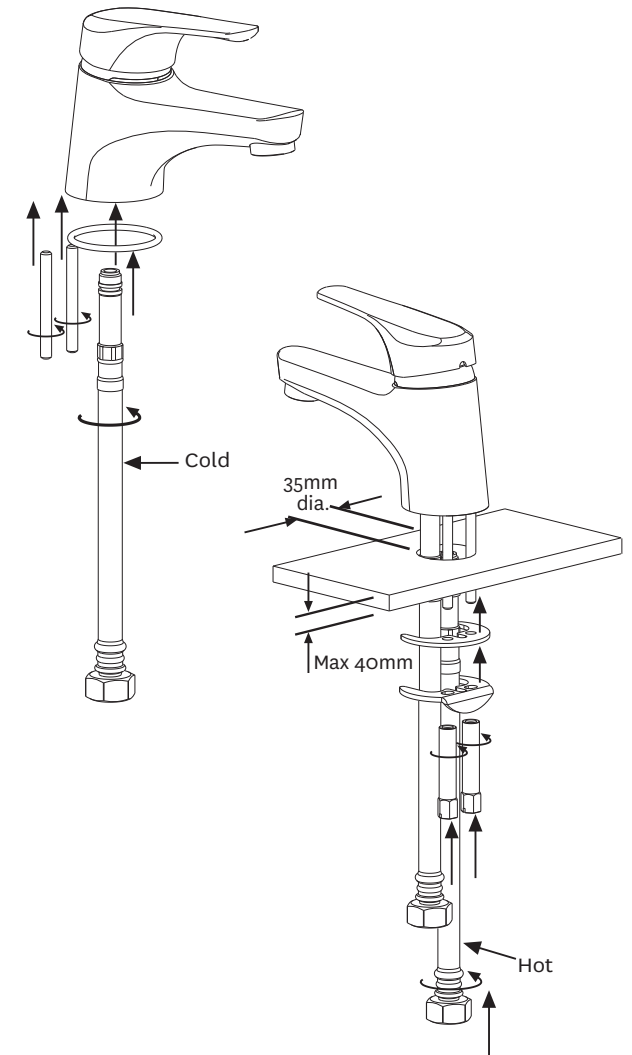

Care and Cleaning:

- Never use abrasives or abrasive cleaning agents to clean this product. Clean regularly with contamination free warm soapy water and a damp soft cloth.

Do not stretch or twist hose

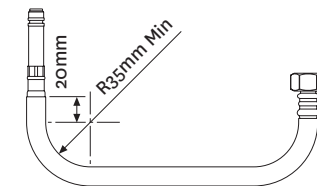
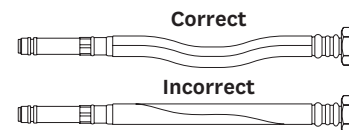

DO NOT crush hose or swaged ends