

CS

s instalační
krabicí do zdi
- index Z

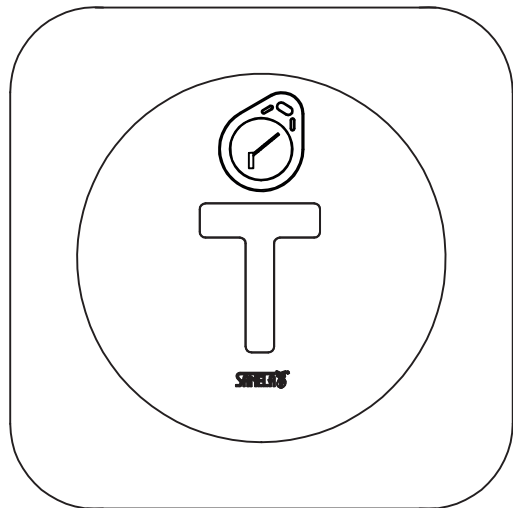

na zeď

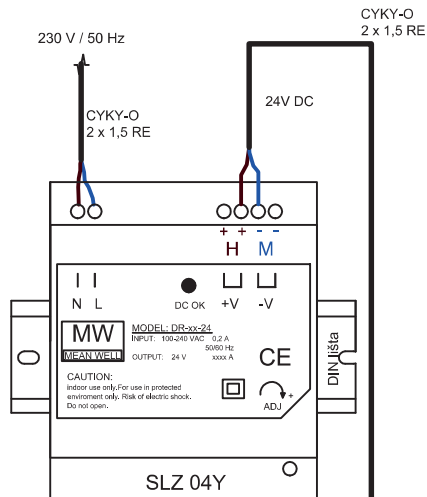
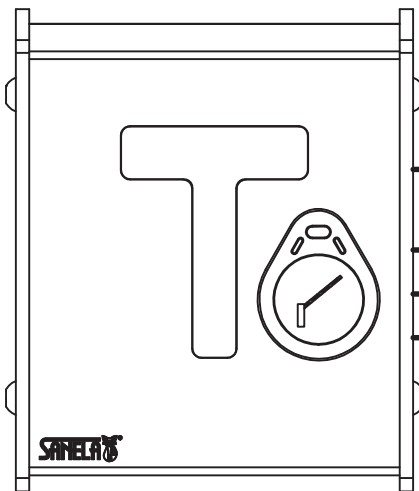

Vodiče nechat dlouhé 40 cm od zdi a před zapojením odstranit vnější izolaci kabelů - pro snadnější modelování kabelů uvnitř zařízení. (viz stavební přípravenost)

24 V DC

OUT 1: 24V / 1A

OUT 2: 24 V / 20 mA

OUT 3: 24 V / 20 mA

CYKY-O 2 x 1,5 RE

CYKY-O 2 x 1,5 RE

CYKY-O 2 x 1,5 RE

LED signalizace

elektroakustický měnič

ZÁVORA



230 V / 50 Hz

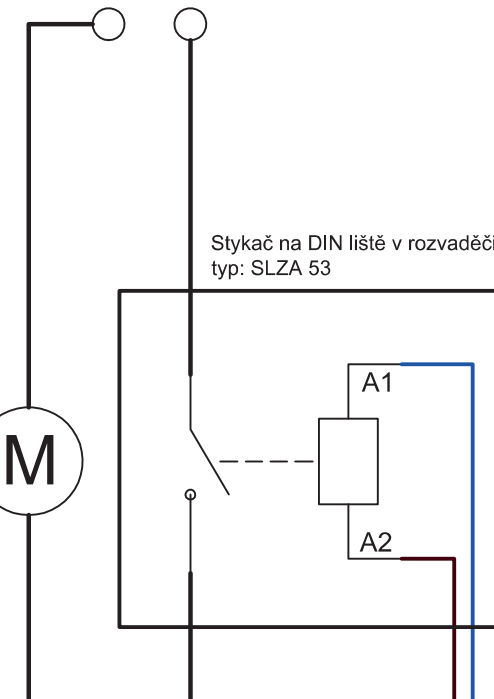

Stykač na DIN liště v rozvaděči
typ: SLZA 53

HNĚDÁ
MODRÁ

Délka vodičů od RFID jednotky ke stykači max. 50 metrů.

INSTALACE:

Montáž výrobku smí provádět pouze osoba způsobilá s příslušným oprávněním dle návodu a předpisů (zde podle vyhl. č. 50/78 Sb.).

EN

with installation box into the wall - Index Z

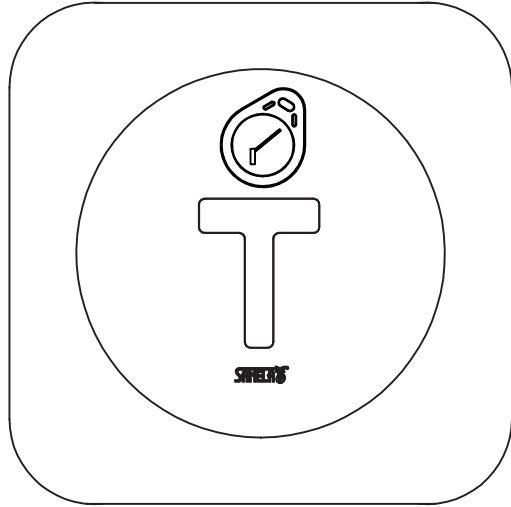

Wall installation

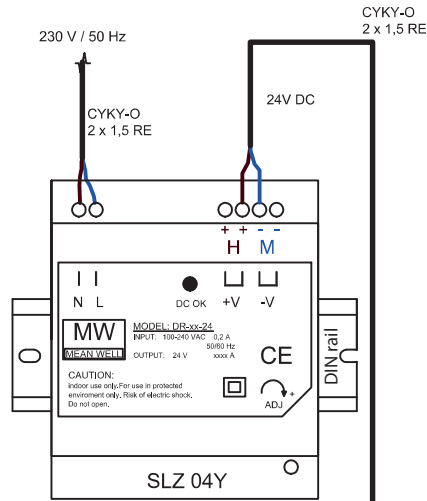
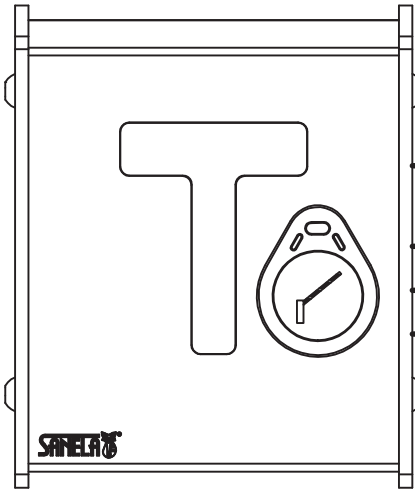

Wires in the box must be min. 40 cm long (from the wall). Before installation, remove the outer cable insulation for easier handling in the box. (see mounting diagram)

24 V DC

OUT 1: 24V / 1A

OUT 2: 24 V / 20 mA

OUT 3: 24 V / 20 mA

CYKY-O 2 x 1,5 RE

CYKY-O 2 x 1,5 RE

CYKY-O 2 x 1,5 RE



LED signaling



electroacoustic transducer

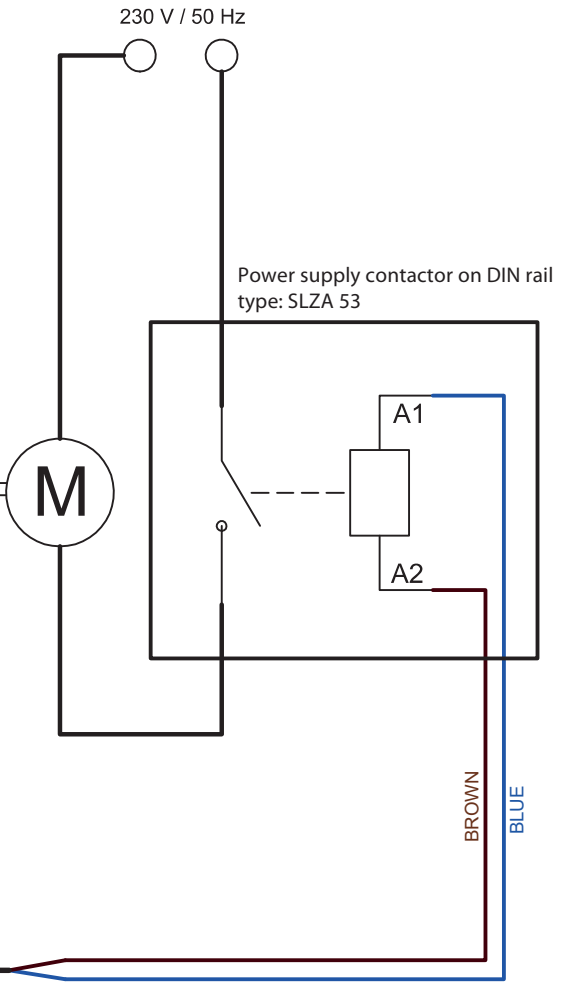
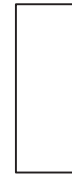
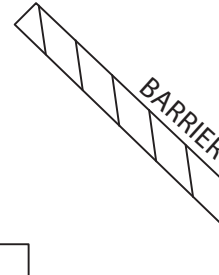

The length of the cables from the RFID unit to the contactor can be a maximum of 50 meters.

INSTALLATION:

Installation of the product may only be carried out by qualified persons with the appropriate authorization in accordance with the instructions and regulations at the installation site!

DE mit Installationsbox
in die Wand
- Index Z

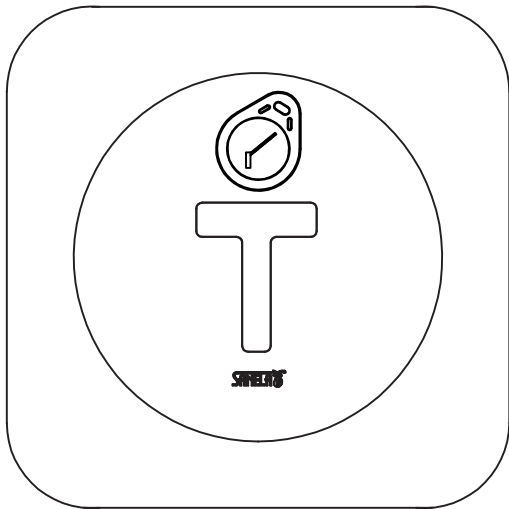

Wandmontage

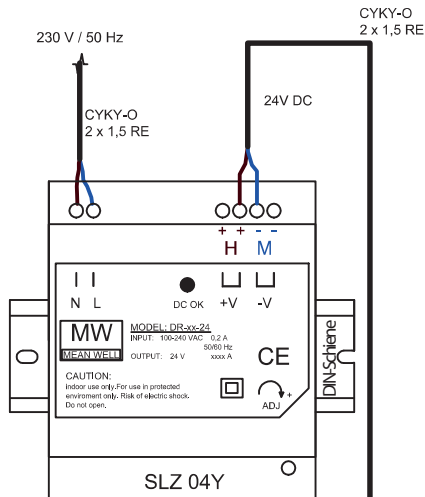
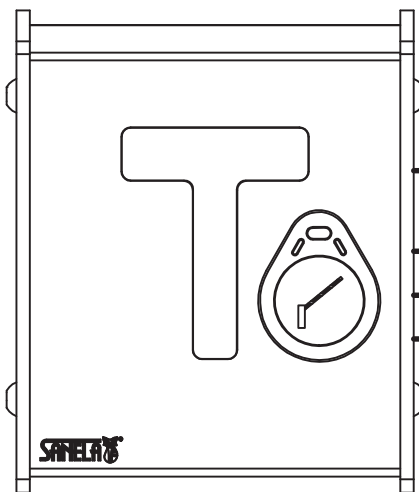

Drähte im Schrank müssen min. 40 cm lang (von der Wand). Vor der Installation entfernen Sie die äußere Kabelisolierung für eine einfachere Handhabung im Schrank. (siehe Baubereitschaft)

24 V DC

OUT 1: 24V / 1A

OUT 2: 24 V / 20 mA

OUT 3: 24 V / 20 mA

CYKY-O 2 x 1,5 RE

CYKY-O 2 x 1,5 RE

CYKY-O 2 x 1,5 RE

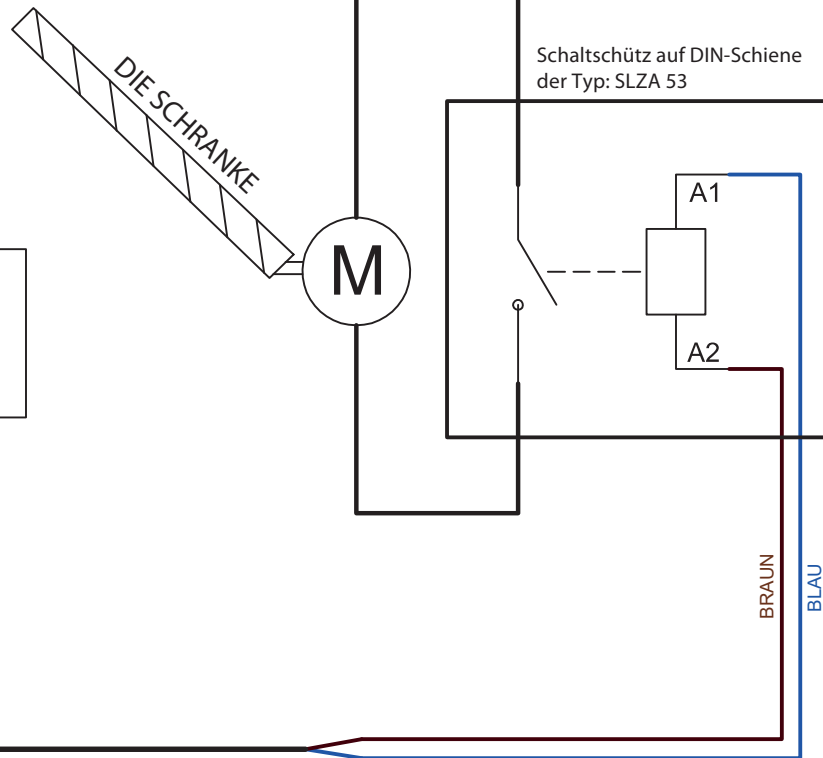

Die Länge der Kable von der RFID Einheit zur Schaltschütz darf maximal 50m betragen.

INSTALLATION:

Installation des Produkts darf nur von qualifizierten Personen mit entsprechender Berechtigung gemäß den Anweisungen und Vorschriften am Aufstellort durchgeföhrt werden