

Features

- Safeguard® slip-resistant surface on bath floor.
- Single threshold for alcove installation with three tile-in flanges.
- KOHLER® enameled cast iron.
- Recessed drain (can be used with K-9157 or K-9159 drain cover).
- Right center drain.
- Ideal size for remodel installations into a 5-foot alcove with a shower door.
- Rim size optimized for water containment and aesthetics.

Required Products/Accessories

K-9157 Drain Cover

or

K-9159 Drain Cover

Recommended Products/Accessories

K-9132 Shower Drain

K-23726 Drain treatment

K-23725 Cast iron cleaner



Codes/Standards

ASME A112.19.1/CSA B45.2







ASTM F462

KOHLER® Enameled Cast Iron Bath and Shower Base Lifetime Limited Warranty

See website for detailed warranty information.

Available Colors/Finishes

Color tiles intended for reference only.

Color	Code	Description
	0	White
	96	Biscuit
	47	Almond
	NY	Dune
	95	Ice™ Grey
	G9	Sandbar

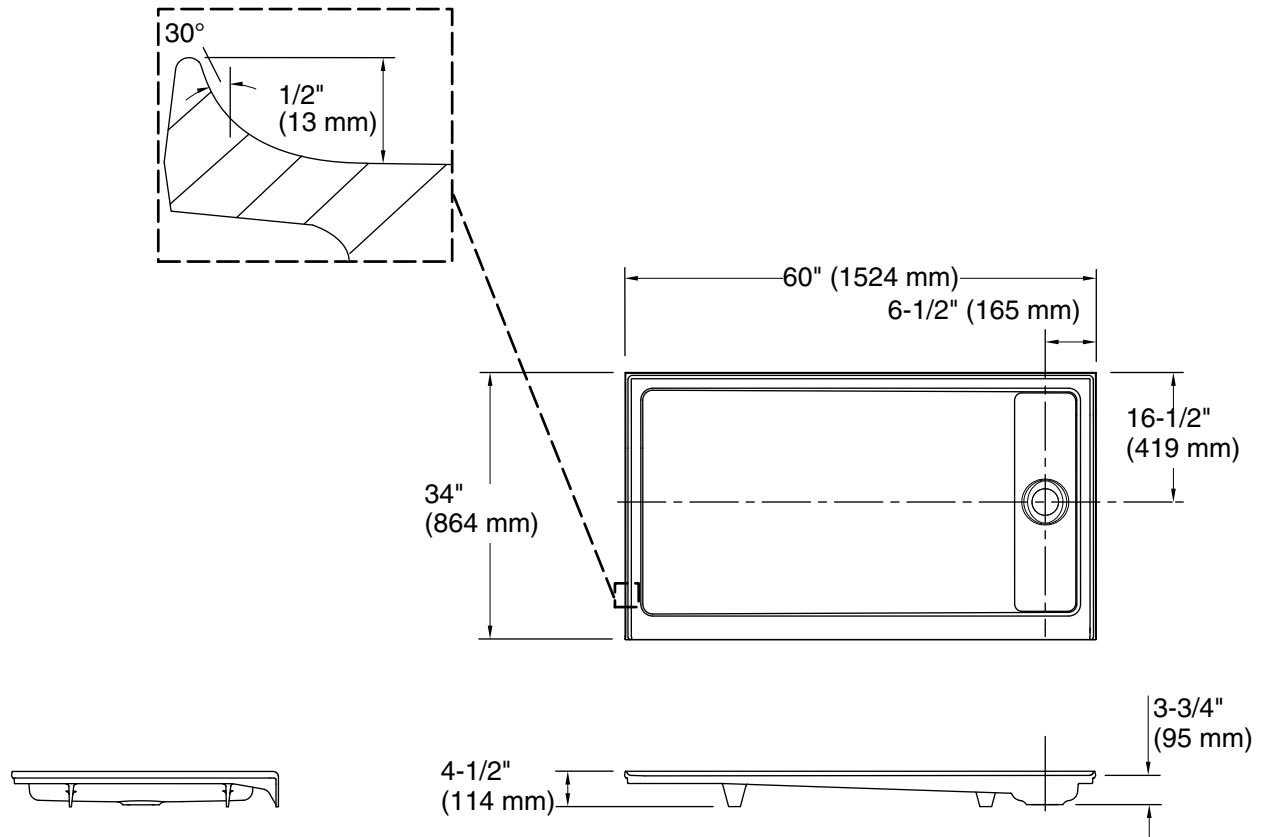

Technical Information

All product dimensions are nominal.

Installation: Three-wall alcove

Drain location: Right

Weight: 193 lbs (87.5 kg)

Notes

Measure your actual product for rough-in details.

Install this product according to the installation instructions.

The dimensions are applicable for this product only and should not be used to fabricate substitute bases for shower enclosures.

KOHLER steam generator/control kit is designed for use with this product. Kohler Co. shall not be responsible for problems encountered due to the installation and use of other manufacturer's steam generators.