

515240520		Wannenfüll- und Brausearmatur DN 15	bath- and shower mixer DN 15
1	518170520	SEITENVENTIL, COLD	SIDE VALVE, COLD
1.1	7530005-00	GRIFF COLD - 1926	HANDLE COLD - 1926
1.1.1	7502205-00	ABDECKKAPPE COLD	COVER CAP COLD
2	518180520	SEITENVENTIL, HOT	SIDE VALVE, HOT
2.1	7530105-00	GRIFF HOT - 1926	HANDLE HOT - 1926
2.1.1	7502305-00	ABDECKKAPPE HOT	COVER CAP HOT
2.2	7502500-00	KERAMIK - OBERTEIL	CERAMIC HEAD PART
2.3	92305905-00	ROSETTE	ESCUTCHEON
2.4	7577100-00	BEFESTIGUNGSSATZ	MOUNTING KIT
2.5	7579000-00	VERSCHLUSSMUTTER	SCREW PLUG
3	7332805-00	AUSLAUF	SPOUT
3.1	7641705-00	STRAHLREGLER	AERATOR
3.2	7400805-00	UMSTELLUNG	DIVERTER
3.2.1	7668505-00	UMSTELLGRIFF	DIVERTER HANDLE
3.2.2	7652100-00	DICHTUNGSSATZ	SEALING SET
3.3	7577100-00	BEFESTIGUNGSSATZ	MOUNTING KIT
3.4	7514705-00	BRÜCKE	BRIDGE
4	7544500-00	DRUCKSCHLAUCH	PRESSURE HOSE
5	7529505-00	HANDBRAUSE	HANDSHOWER
5.1	85503405-00	SIEB	MESH
5.2	92313200-00	PORZELLANGRIFF HANDBRAUSE	PORCELAIN-HANDLE FOR HANDSHOWER
6	7600605-00	BRAUSEHALTER	SHOWER HOLDER

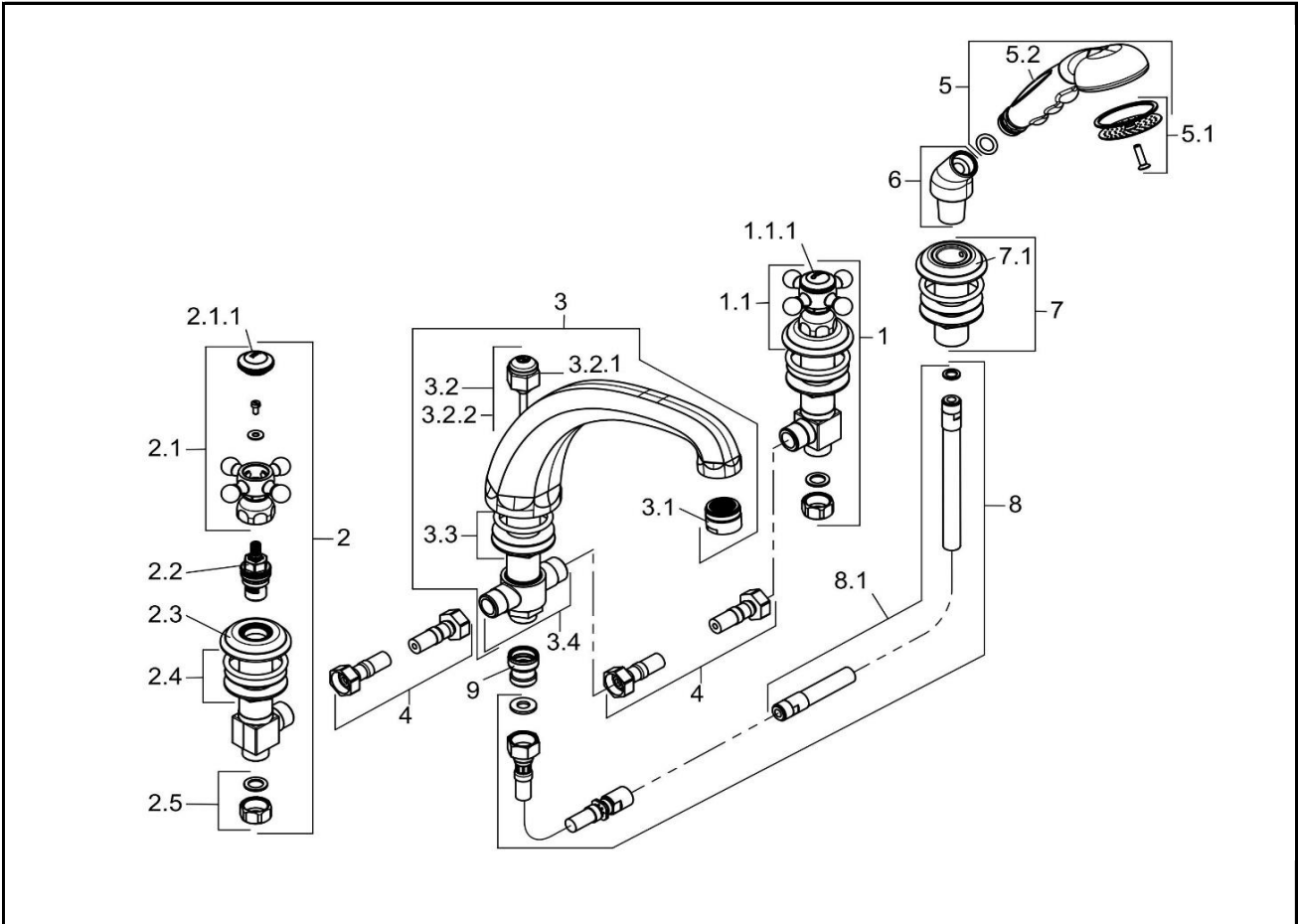

515240520		Wannenfüll- und Brausearmatur DN 15	bath- and shower mixer DN 15
7	7601105-00	SCHLAUCHDURCHFÜHRUNG	GUIDING SHAFT FOR FLEX HOSE
7.1	92306005-00	ROSETTE	ESCUTCHEON
8	7680400-00	BRAUSESCHLAUCH	SHOWER HOSE
8.1	7668305-00	BRAUSESCHLAUCH	SHOWER HOSE
9	7642000-00	RÜCKFLUSSVERSCHRAUBUNG	BACK FLOW PREVENTER COUPLING