

27-8.3V-CL15

Floor Standing Bath Set with Volume Hand Shower

Requires SS-FL8.3 concealed rough

Hand Shower Flow Rate: 1.75 GPM

Note: Some building codes require remote pressure balance valves for anti-scald

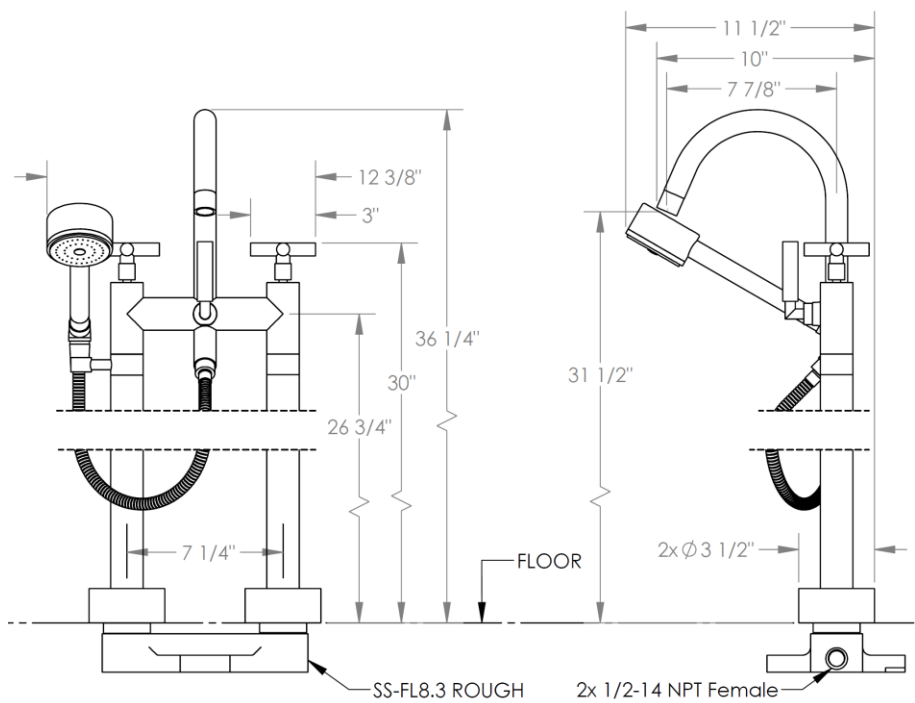
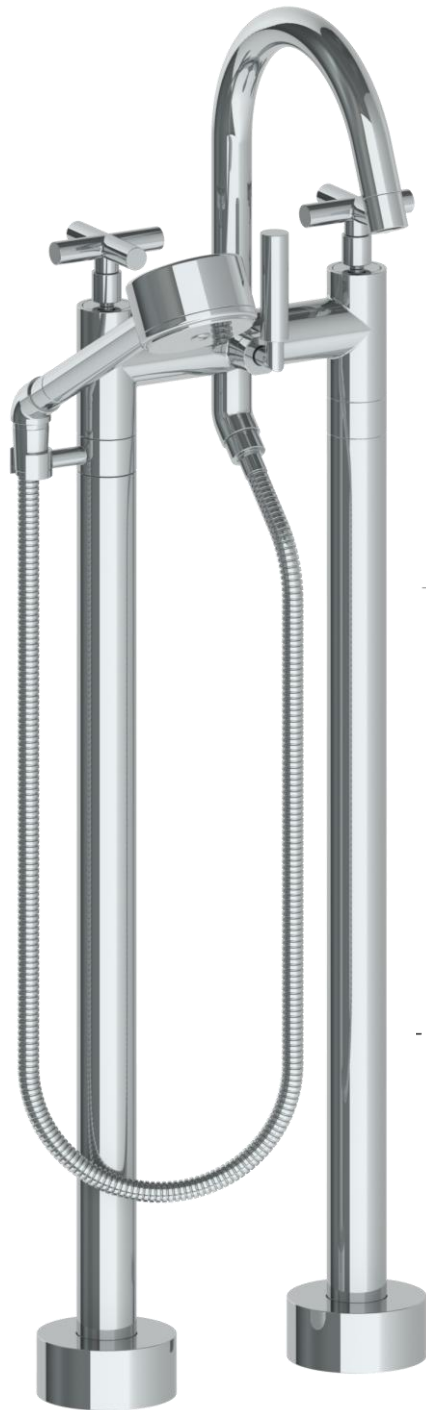

Meets the applicable requirements of ASME A112.18.1-2005/CSA B125.1-05, entitled "Plumbing Supply Fittings"