

Art.: H1602 09 09

Conexión flexible trenzada GEFLEX DN50 M 2" - H 2"
Flexible connection braided GEFLEX DN50 M 2" - F 2"

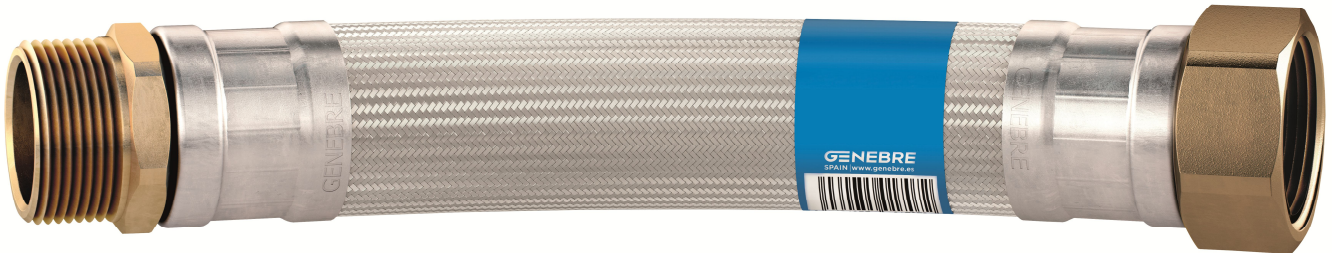

Descripción	Description
Conexiones flexibles trenzadas DN50 fabricadas según normativa UNE-EN 13618. Calidad alimentaria según NF XP P 41-280. Junta de EPDM incluida. Racores según EN ISO 228-1. Utilizados para suministro de agua potable.	Flexible DN50 braided connections manufactured according to UNE-EN 13618 standards. Food quality according to NF XP P 41-280. EPDM gasket included. Fittings according to EN ISO 228-1. Used for drinking water supply.

Aplicaciones / Applications			
Calentadores Heaters	Bateria de contadores Counter battery	Grupos de presión Pressure groups	Fan-coils

Características / Features	
<p>DN50 Conexiones flexibles DN50 Ø Int.50 mm Ø Ext.58 mm Flexible connections DN50 Ø Int.50 mm Ø Ext.58 mm</p>	<p>Radio mínimo de curvatura 200 mm Minimum radius of curvature 200 mm</p>
<p>Presión máxima trabajo 7 Bar Maximum work pressure 7 Bar</p>	<p>Diámetro interior del racor 41 mm Fitting inner diameter 41 mm</p>
<p>Temperatura máxima trabajo 90° C. Temperatura mínima trabajo 5° C Maximum work temperature 90°C. Minimum work temperature 5°C.</p>	<p>Caudal. Ver pagina 4 Flow rate. See page 4</p>

Dimensiones / Dimensions



Referencia Reference	Descripción / Description	Conector A Connector A	Conector B Connector B	Longitud Lenght
H1602 09 09 030	GEFLEX DN50 M 2" – F 2" 30 cm	M 2"	F 2"	30 cm
H1602 09 09 040	GEFLEX DN50 M 2" – F 2" 40 cm	M 2"	F 2"	40 cm
H1602 09 09 050	GEFLEX DN50 M 2" – F 2" 50 cm	M 2"	F 2"	50 cm
H1602 09 09 060	GEFLEX DN50 M 2" – F 2" 60 cm	M 2"	F 2"	60 cm
H1602 09 09 080	GEFLEX DN50 M 2" – F 2" 80 cm	M 2"	F 2"	80 cm
H1602 09 09 100	GEFLEX DN50 M 2" – F 2" 100 cm	M 2"	F 2"	100 cm

Materiales / Materials

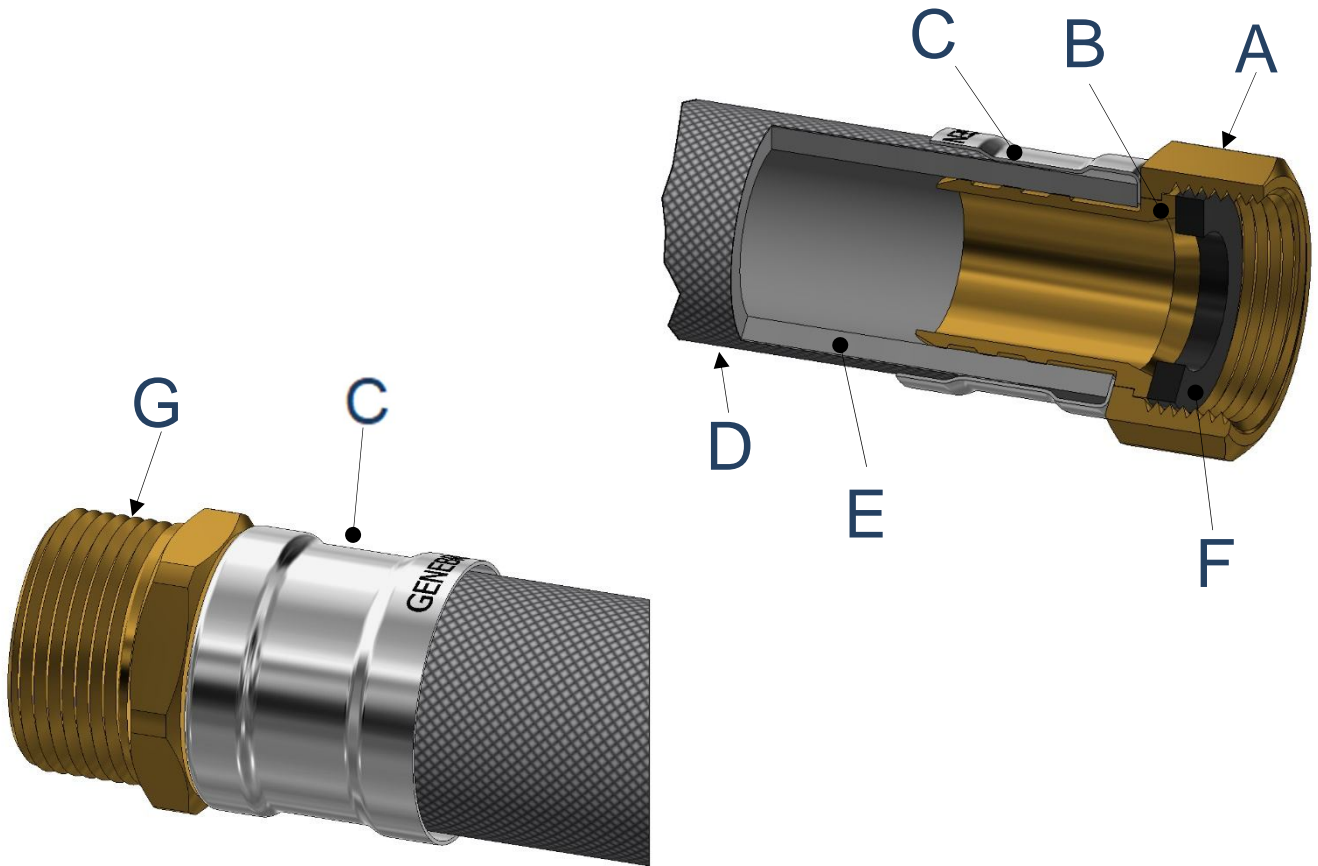

Descripción / Description	Posición / Position	Material	Acabado / Finished
Tuerca 2" DN50 / 2" DN50 Nut	A	Latón CW617N / Brass CW617N	Limpiado al ácido / Cleaned to acid
Inserto 2" DN50 / 2" DN50 Insert	B	Latón CW617N / Brass CW617N	Limpiado al ácido / Cleaned to acid
Casquillo / Sleeve	C	Acero Inoxidable AISI 304 Stainless Steel AISI 304	---
Malla / Braiding	D	Acero Inoxidable AISI 304 Stainless Steel AISI 304	---
Tubo Interior / Inner tube	E	EPDM	---
Junta plana 2" DN50 / Gasket 2" DN50	F	EPDM	---
Macho 2" DN50 / 2" DN50 Male	G	Latón CW617N / Brass CW617N	Limpiado al ácido / Cleaned to acid

Ver consejos de Instalación / See Installation tips

