

35-8.8-ED1

1/2" Floor Mounted Elevated Tub Filler & Hand Held Shower

Includes In-Floor Rough SS_248.8FLR-RGH

Hand Shower Flow Rate: 2 GPM @ 45 PSI

Tub Spout Flow Rate: 8 GPM @ 45 PSI

Note: Some building codes require remote pressure balance valves such as SS-PB50 for anti-scald

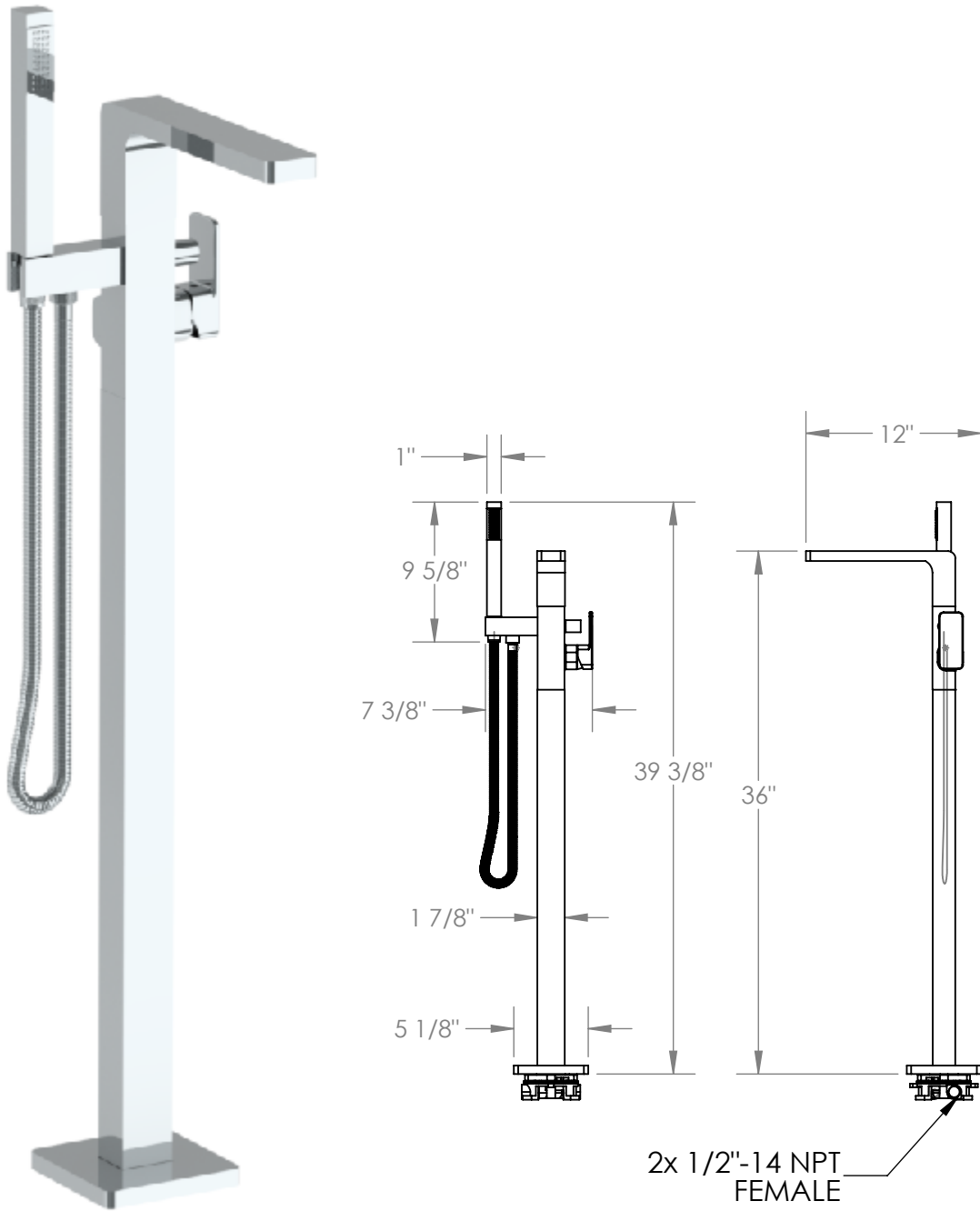

Meets the applicable requirements of ASME A112.18.1-2005/CSA B125.1-05, entitled "Plumbing Supply Fittings"

WATERMARK DESIGNS 8/18/2020

350 Dewitt Ave Brooklyn NY 11207 USA T 718 257 2800 F 718 257 2144 info@watermark-designs.com