



SERIES ALG400

ESBE
NO.1 IN HYDRONIC SYSTEM CONTROL



Series ALG434
Series ALG436
Series ALG438

CE
LVD 2014/35/EU
EMC 2014/30/EU
RoHS 2011/65/EU

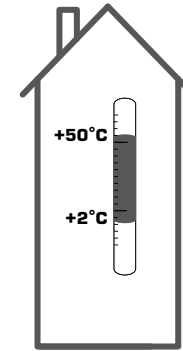

Mtrl.nr. 9814 09 64 • Ritn.nr. 8470 utg A • Rev. 1511

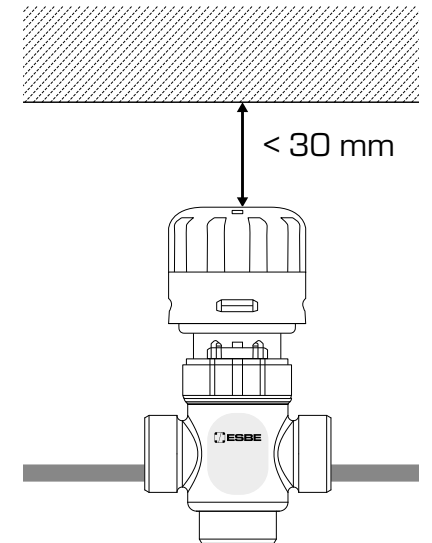
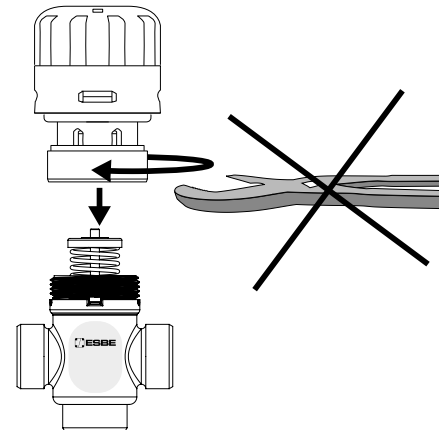
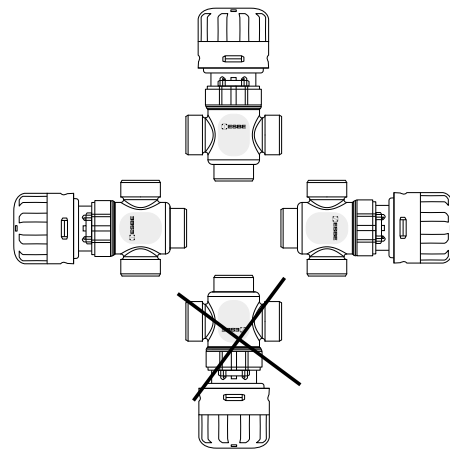
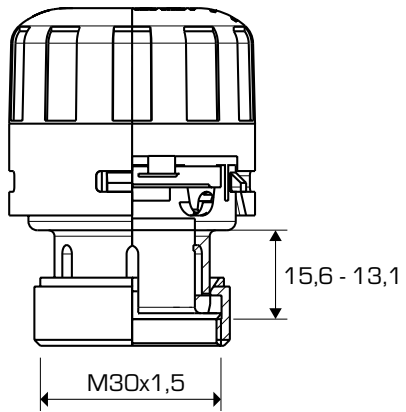

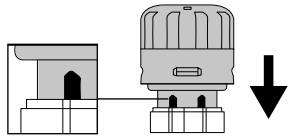
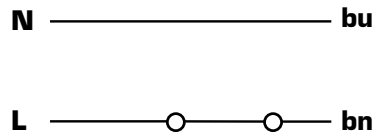
2A**Serie ALG434 /ALG436 2-p**

Serie VLG122

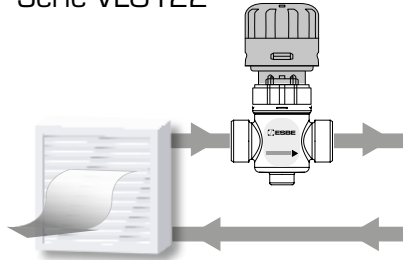

Serie VLG132

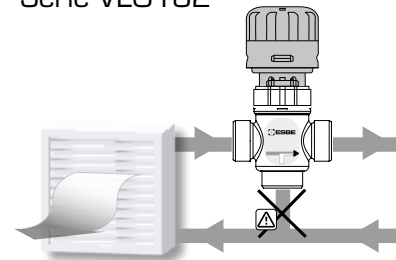

Serie VLG142

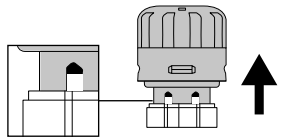
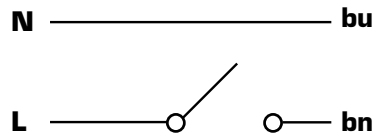
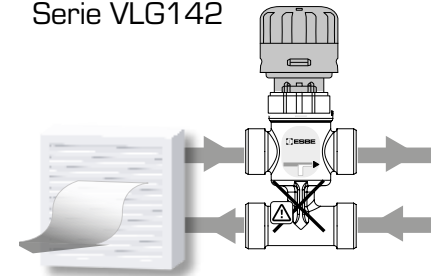

Serie VLG122

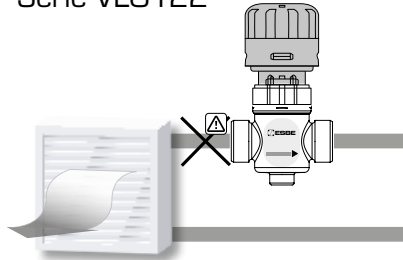

Serie VLG132

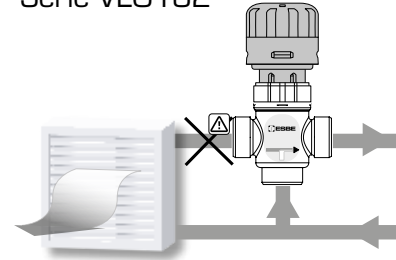

Serie VLG142

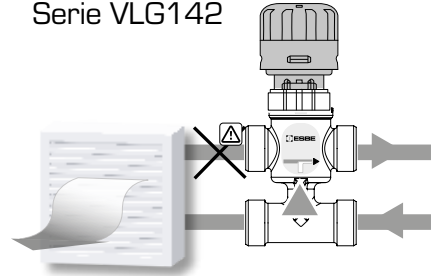
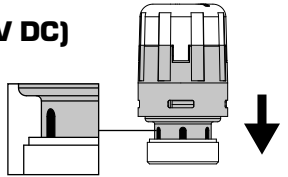
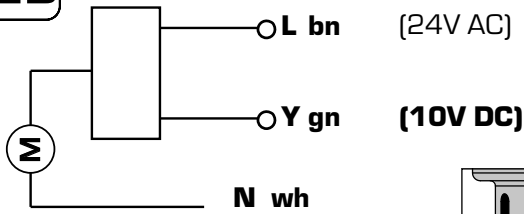
*Piping Schematics are General Representations***2B****Serie ALG438 Prop**

Serie VLG122

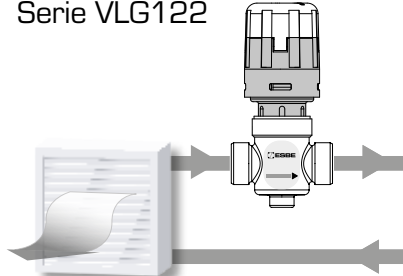

Serie VLG132

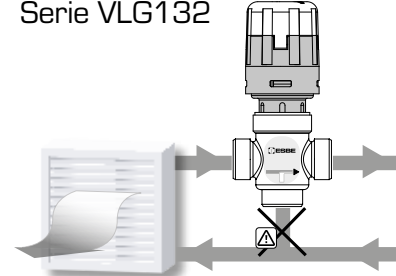

Serie VLG142

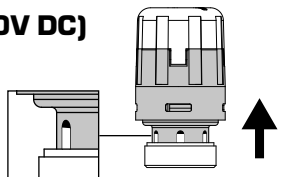
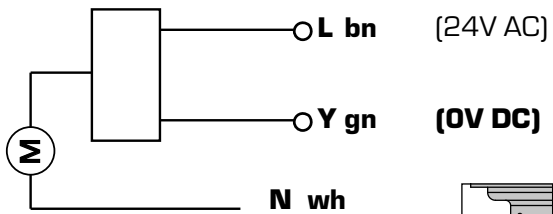
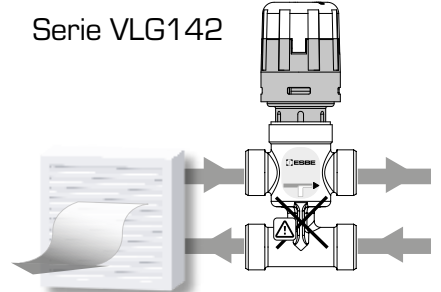

Serie VLG122

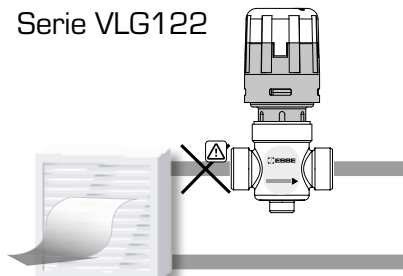

Serie VLG132

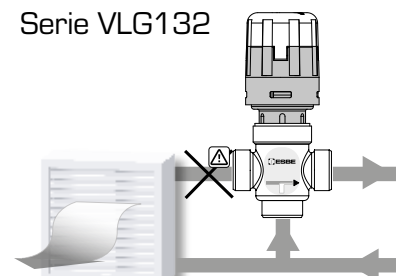

Serie VLG142

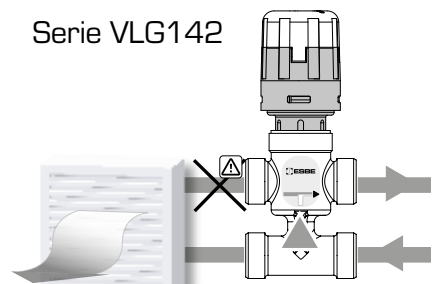
*Piping Schematics are General Representations*