



Catchpole & Rye

Saracens Dairy,
 Pluckley,
 Kent. U.K.
 TN27 0SA.
 TEL: +44 (0)1233 840840
 EMAIL: info@catchpoleandrye.com

Product Range:

Baths

Product Name:

The 2000mm Metal Bateau

DIMENSIONAL DATA SHEET
 DATE: AUGUST 2018

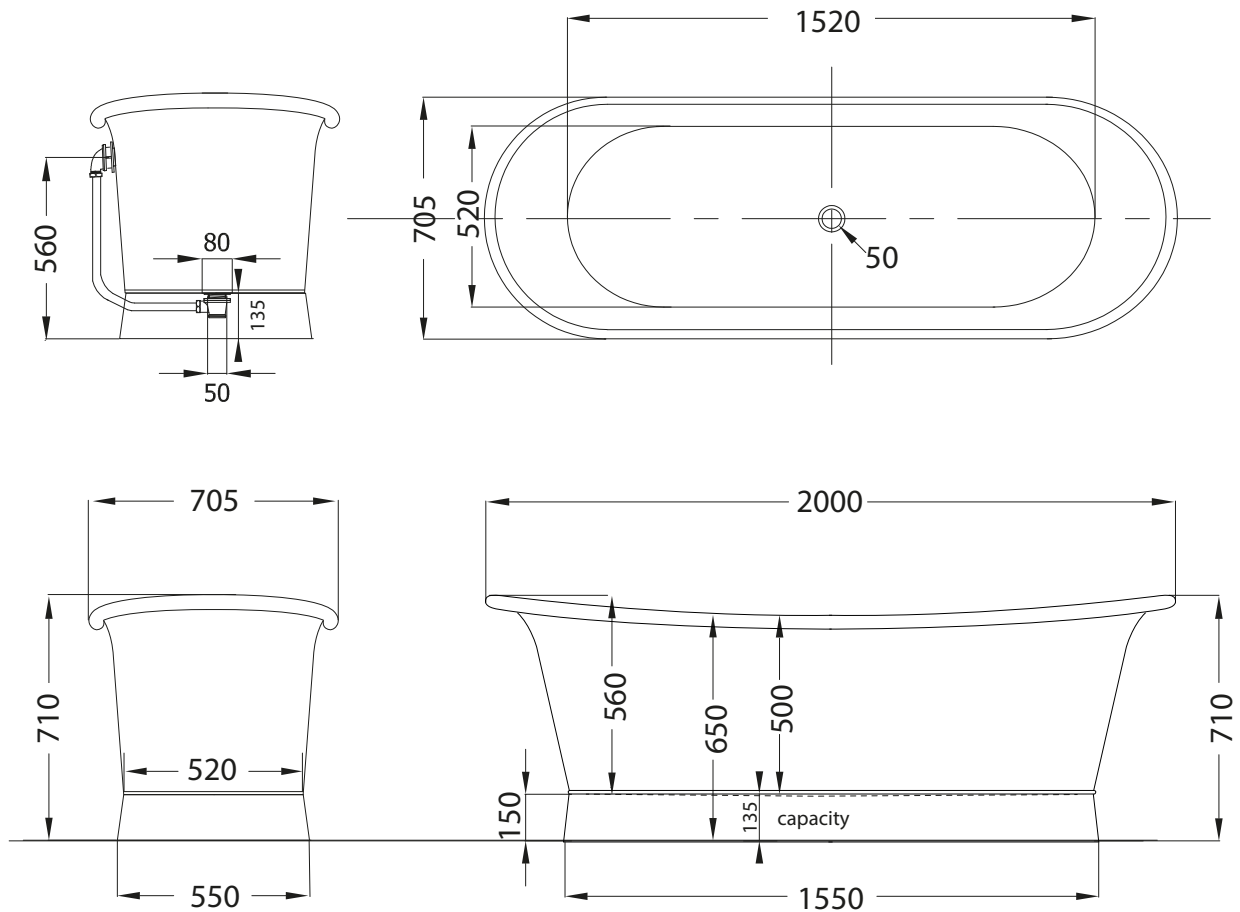

NOTES:

DIMENSIONS IN MILLIMETRES.

WHILST EVERY EFFORT IS MADE TO ENSURE THE ACCURACY OF THESE DATA SHEETS THEY ARE SUBJECT TO CHANGE WITHOUT NOTICE AS PART OF THE COMPANY'S PRODUCT DEVELOPMENT PROCESS.