













28 033 970



- rain shower Ø 300 mm
- PURE RAIN, max. flow rate 12 l/min (at 3 bar)
- PURIFY RAIN, max. flow rate 6 l/min (at 3 bar)
- min. recess depth 137 mm
- with anti-scale system
- For simultaneous control of the jet types, we recommend the xTool thermostat module
- Not suitable for use in a steam room.
- WRAS 240502006

Fits: TARA, LISSÉ, VAIA, META

	Champagne (22kt Gold)	28 033 970-47
	Chrome	28 033 970-00
	Brushed Platinum	28 033 970-06
	Platinum	28 033 970-08
	Dark Chrome	28 033 970-19
	Light Gold	28 033 970-26
	Brushed Light Gold	28 033 970-27
	Brushed Durabronze (23kt Gold)	28 033 970-28
	Matte Black	28 033 970-33
	Brushed Bronze	28 033 970-42
	Brushed Champagne (22kt Gold)	28 033 970-46
	Brushed Chrome	28 033 970-93
	Brushed Dark Platinum	28 033 970-99

Required miscellaneous



**Concealed ceiling installation box for recessed ceiling installation -** 35 033 970 90

- concealed rough parts
- recess depth 137mm
- 2x female thread " outlet
- flush-mounted installation box Ø 360 mm RAL 9003 signal white

28 033 970

mm [inches]

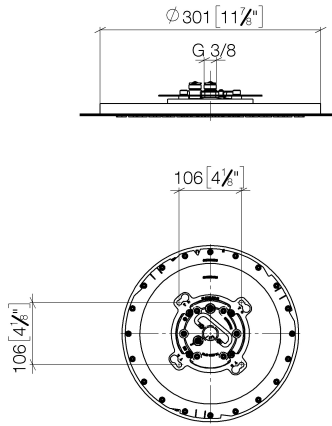

Flow rate chart

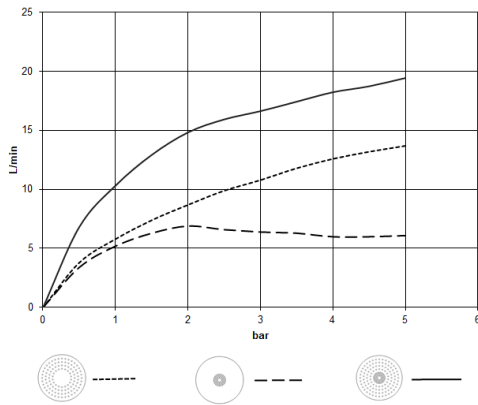

Codes & Standards

DIN 4109

ISO 3822

Scottish Water  
Byelaws

UK Water Supply  
Regulations

Ü-Zeichen



Rain shower for recessed ceiling installation 300 mm - Champagne (22kt Gold)

---

TARA

28 033 970

Certificates

---

LGA\_38

WRAS\_240502

Product version from 5/1/2022

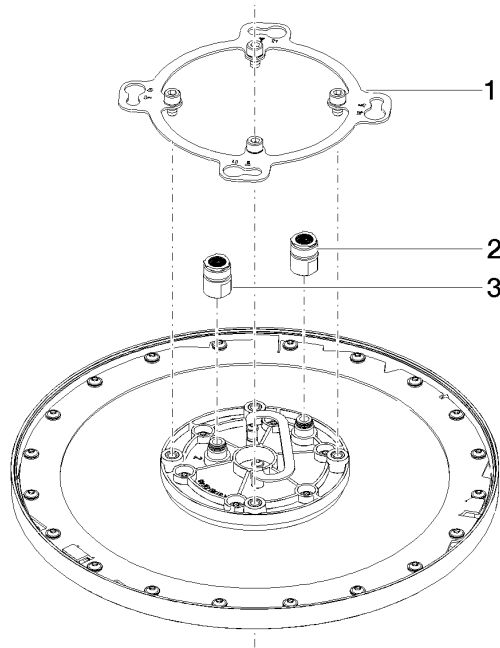



Rain shower for recessed ceiling installation 300 mm - Champagne (22kt Gold)

TARA

28 033 970

**Spare parts list**

**Product version from 5/1/2022**

No.	Item Number	Name	Quantity used	Delivery time
	90 17 20 262 00 90	flange	3	2