

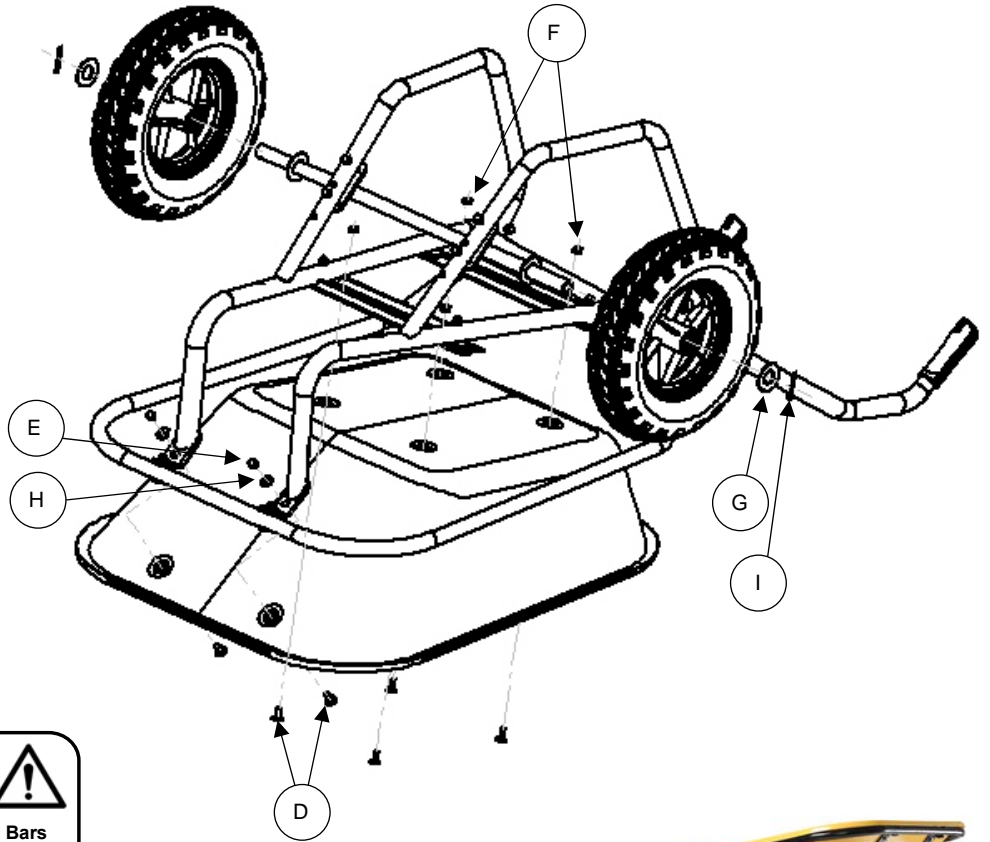

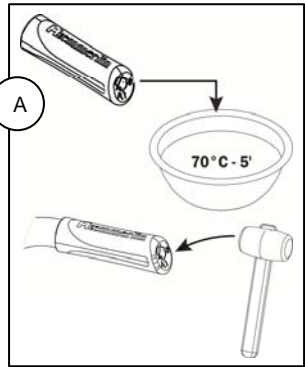

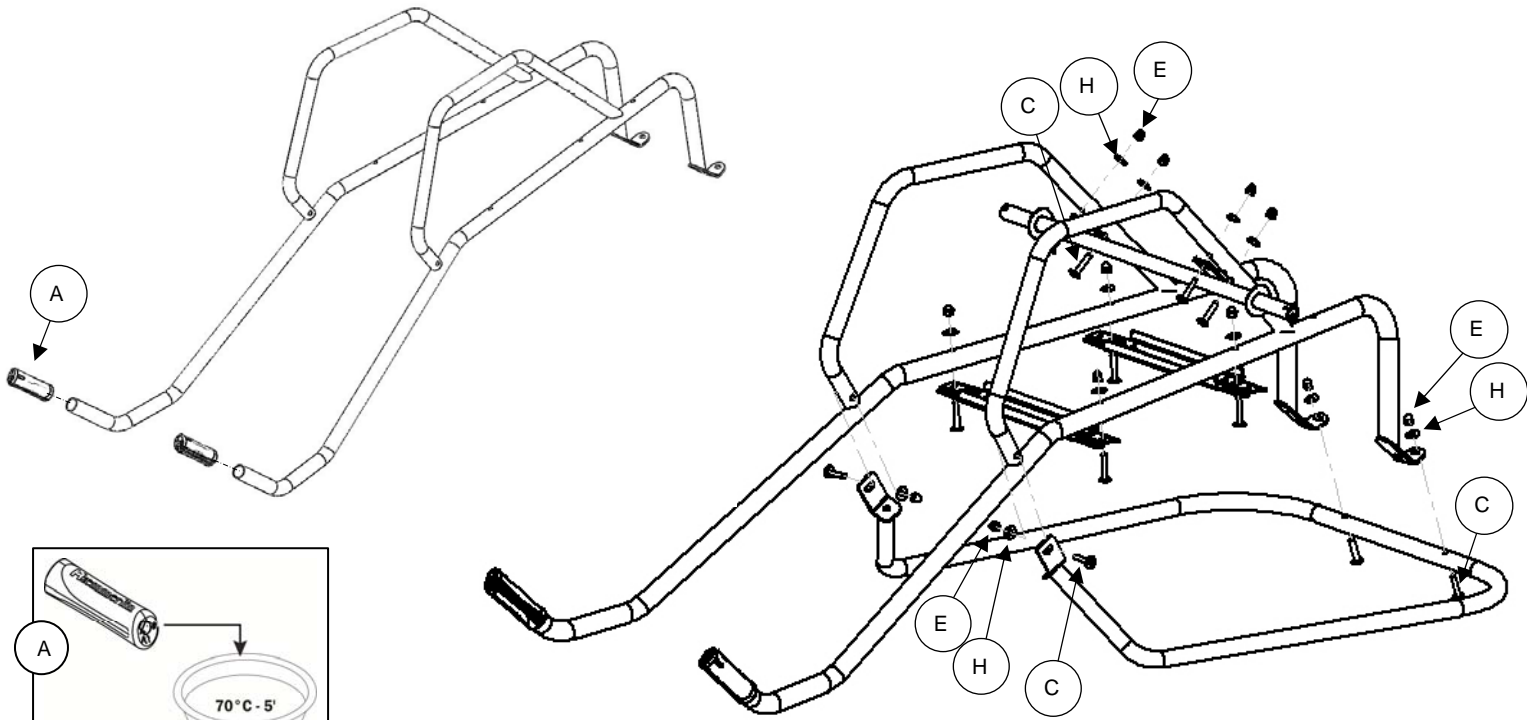

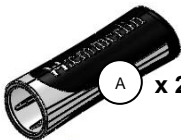

# BROUETTE / WHEELBARROW / SCHUBKARRE / ТАЧКА

## CARGO TWIN EXCELLIUM 160





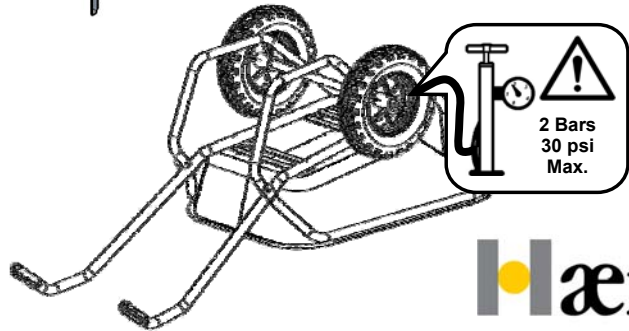



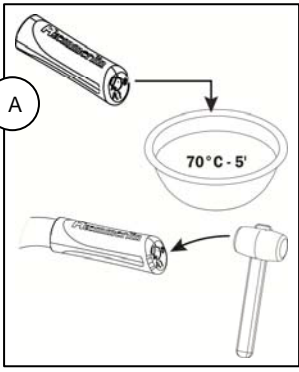
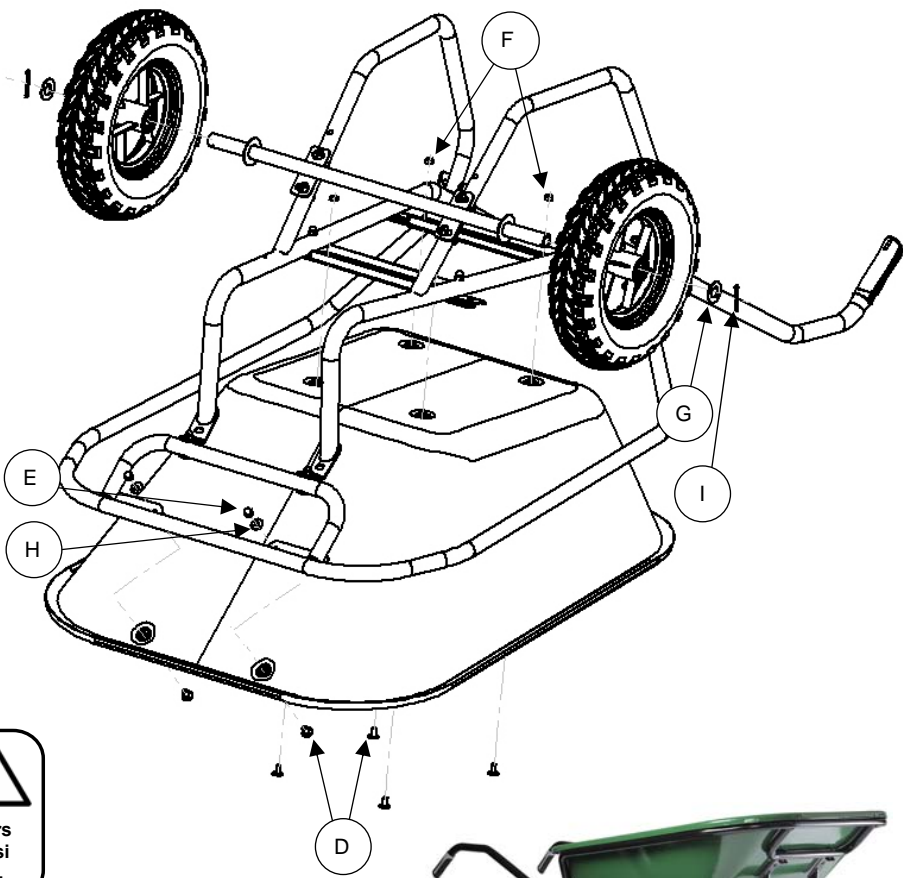
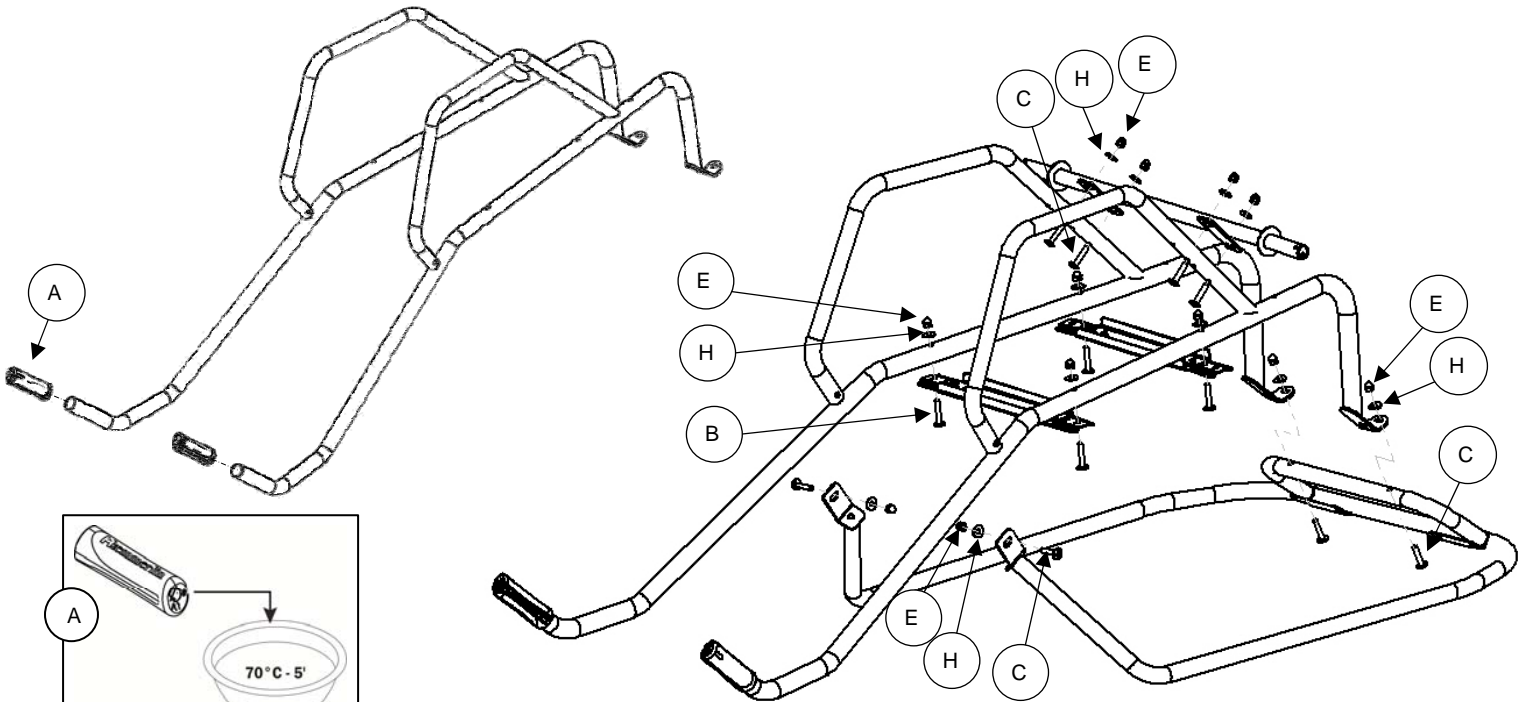

-  A x 2
-  B x 4
-  C x 8
-  D x 6
-  E x 14
-  F x 4
-  G x 2
-  H x 14
-  I x 2

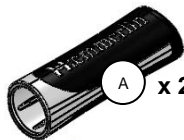

# BROUETTE / WHEELBARROW / SCHUBKARRE / ТАЧКА

## CARGO TWIN EXCELLIUM 230



-  A x 2
-  B x 4
-  C x 8
-  D x 6
-  E x 14
-  F x 4
-  G x 2
-  H x 14
-  I x 2

