

Features

- Single-speed whirlpool offers performance and value, with 8 fully adjustable jets.
- Hydromassage flow and direction can be controlled at each jet.
- Comfort Depth® design offers a convenient 19" step-over height while retaining the same depth as a standard 21" bath.
- Molded lumbar support offers extra comfort while bathing.
- Slotted overflow allows for deep soaking.
- Integral apron.
- Integral flange helps prevent water from seeping behind wall and simplifies alcove installation.
- Textured bottom surface.
- Coordinates with other products in the Archer collection.

Material

- Acrylic.

Hydrotherapy

- Whirlpool.

Installation

- Left drain.
- Alcove.

Required Products/Accessories

- K-7271 Brass Slotted Overflow Bath Drain
- or
- K-7272 PVC Slotted Overflow Bath Drain

Recommended Products/Accessories

- K-24916 Wireless Music Kit
- K-23726 Drain treatment
- K-23732 Tub & shower cleaner



ADA

Codes/Standards











ASME A112.19.7/CSA B45.10
CSA B45.5/IAPMO Z124
UL 1795
CSA C22.2 No. 218.2
ADA
ICC/ANSI A117.1

**KOHLER® Plastic Baths and Receptors
Lifetime Limited Warranty
KOHLER® Hydrotherapy Components
Five-Year Limited Warranty**

See website for detailed warranty information.

Available Colors/Finishes

Color tiles intended for reference only.

Color	Code	Description
	0	White
	96	Biscuit
	47	Almond
	NY	Dune
	95	Ice™ Grey
	G9	Sandbar
	33	Mexican Sand™
	K4	Cashmere
	58	Thunder™ Grey
	7	Black Black™

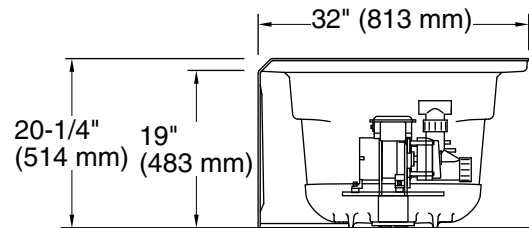
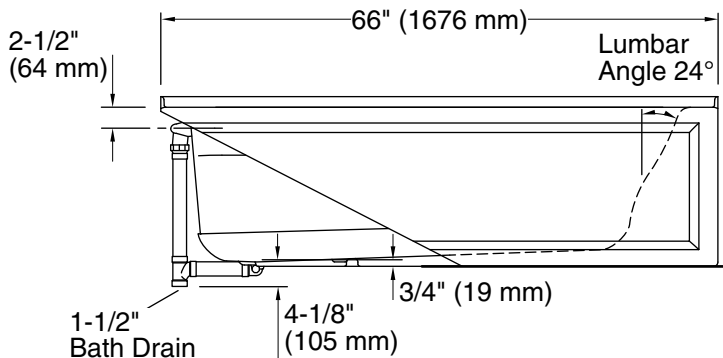
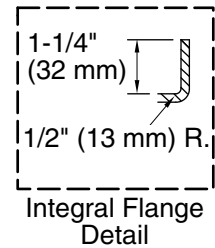
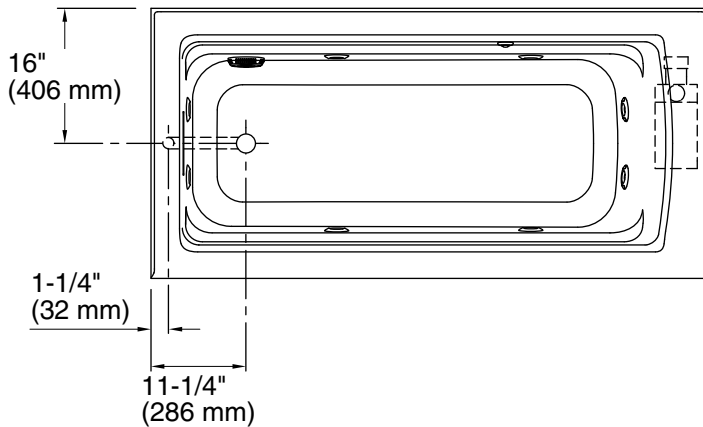

Required Electrical Service

One dedicated circuit required, protected with Class A Ground-Fault Circuit-Interrupter (GFCI). Outside North America, this device may be known as a Residual Current Device (RCD).

Pump: 120 V, 15 A, 60 Hz

Technical Information

All product dimensions are nominal.

Installation: Three-wall alcove
 Drain location: Left
 Basin area, bottom: 50-3/8" x 19-5/8" (1280 mm x 498 mm)
 Basin area, top: 57-5/16" x 24-1/16" (1456 mm x 611 mm)
 Weight: 120 lbs (54.4 kg)
 Minimum floor load: 47 lbs/ft² (229.5 kg/m²)
 Water depth: 15-5/16" (389 mm)
 Water capacity: 66 gal (249.8 L)
 Electrical component rating: Pump: 120 V, 7 A, 60 Hz
 Pump speed: Single
 Minimum flat for door: 2-3/16" (55 mm)

No change in measurements if connected with drain illustrated. (K-7272)

Notes

Measure your actual product for rough-in details. Install this product according to the installation instructions.

The hot water supply should be 70% of the capacity of the bath or greater. Installations will vary.

ADA compliant when installed to the specific requirements of these regulations.