

5194000

FINEZZA DUE Series

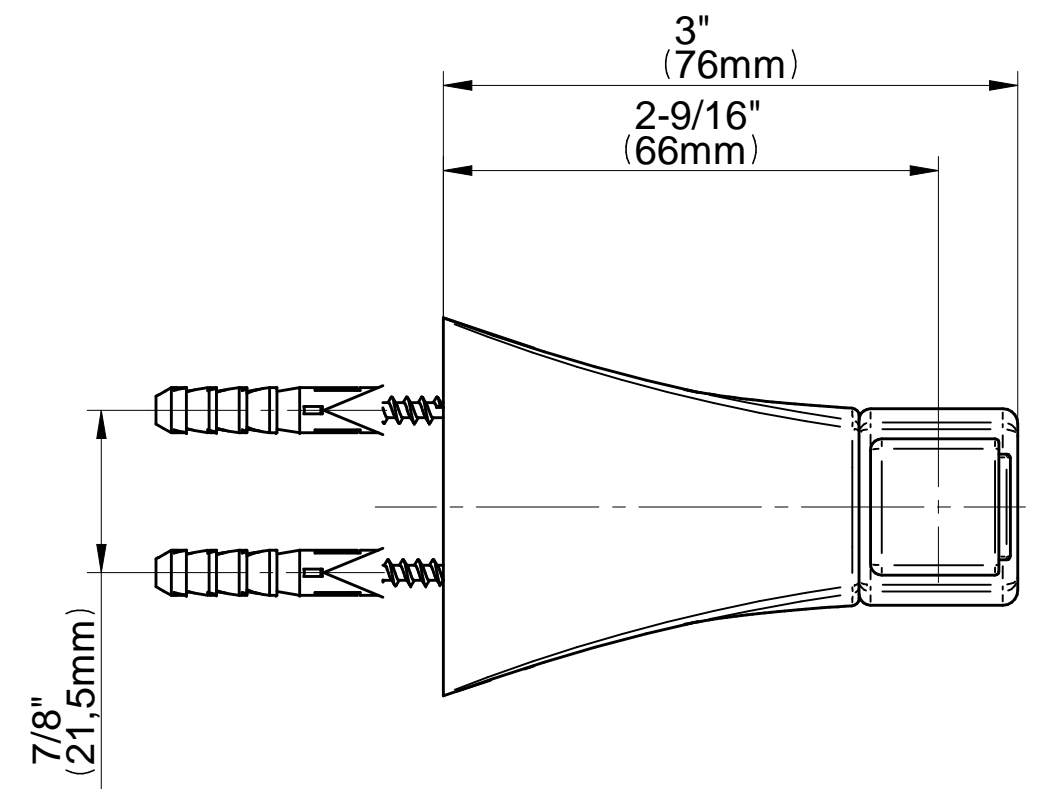
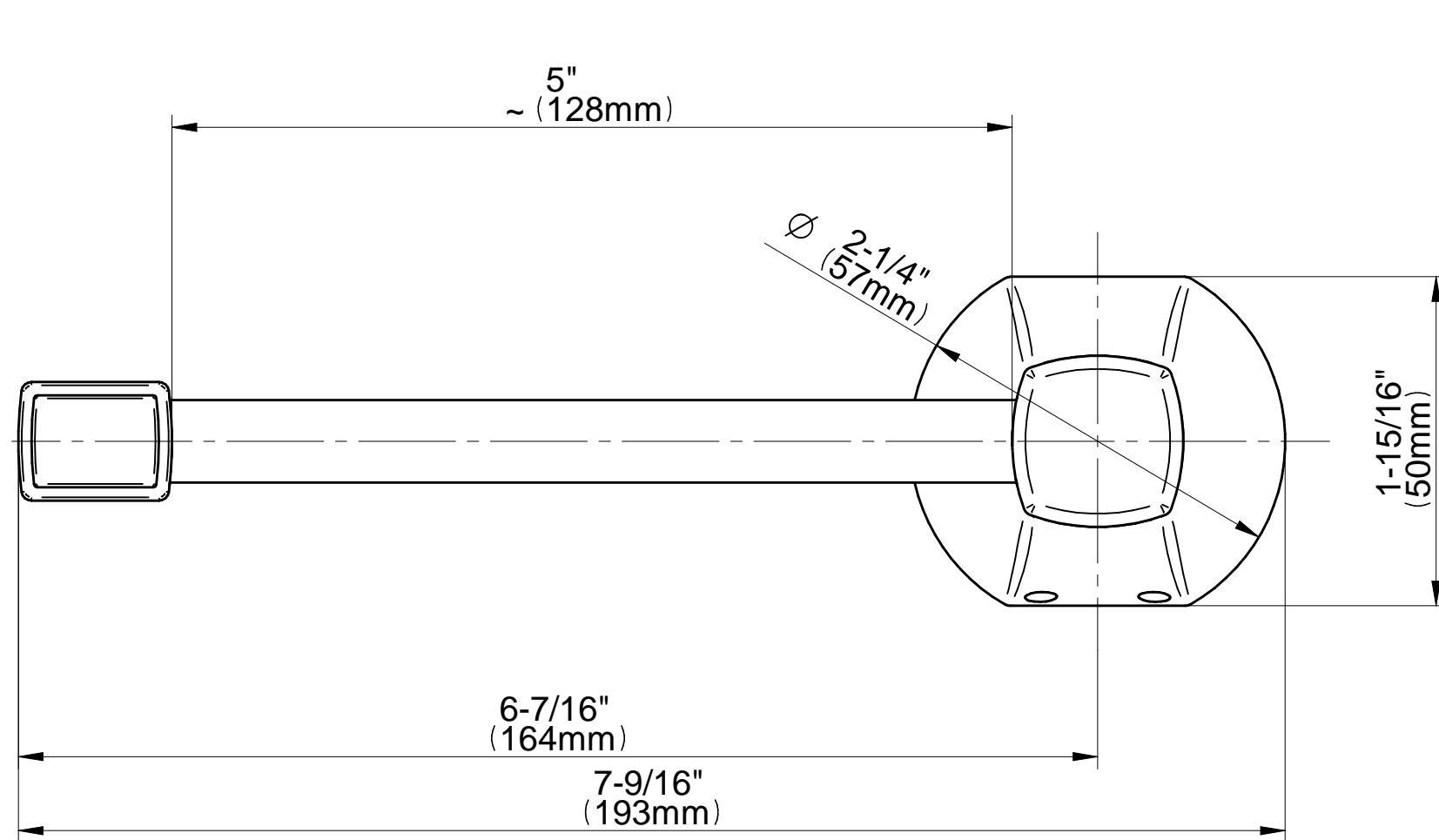

SOLID EDGE RESELLER COPY

GRAFF[®]
CUTTING EDGE DESIGN