

#### Features

- Low-threshold design for easy entry and exit.
- Recessed rear drain.
- Single threshold for three-wall installation.
- Requires K-9333 Groove aluminum drain cover or K-9337 Groove teak drain cover (sold separately).

#### Material

- Acrylic.

#### Required Products/Accessories

K-9333 Drain Cover

or

K-9337 Drain Cover

#### Recommended Products/Accessories

K-9132 Shower Drain

K-23726 Drain treatment

K-23732 Tub & shower cleaner



#### Codes/Standards

CSA B45.5/IAPMO Z124

ASTM E162







ASTM E662

#### KOHLER® Plastic Baths and Receptors Lifetime Limited Warranty

See website for detailed warranty information.

#### Available Colors/Finishes

*Color tiles intended for reference only.*

| Color  | Code | Description |
|--|------|-------------|
|  | 0    | White       |
|  | 96   | Biscuit     |
|  | 47   | Almond      |
|  | NY   | Dune        |
|  | 95   | Ice™ Grey   |
|  | G9   | Sandbar     |

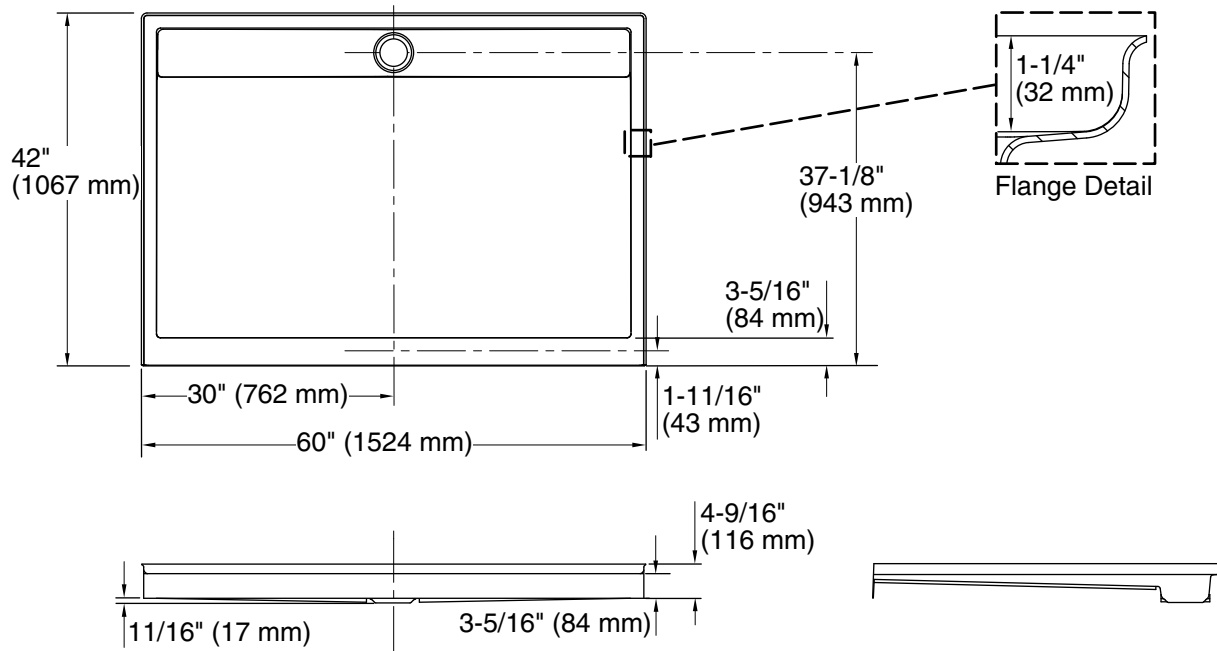

#### Technical Information

All product dimensions are nominal.

|                     |  |
|---------------------|--|
| Installation:       | Three-wall alcove                                |
| Drain location:     | Center rear                                      |
| Weight:             | 72 lbs (32.7 kg)                                 |
| Minimum floor load: | 20 lbs/ft <sup>2</sup> (97.6 kg/m <sup>2</sup> ) |

#### Notes

- Measure your actual product for rough-in details.
- Install this product according to the installation instructions.
- Shimming may be required to level the fixture.
- Shimming may be required between the stud frame and the fixture.
- Stud opening tolerance is + 1/4" (6 mm), - 0" (0 mm).