

**DANIEL**  
RUBINETTERIE

MILANO

SCHEDA TECNICA TECHNICAL FEATURES

ART. COD.

**SR710D2P**

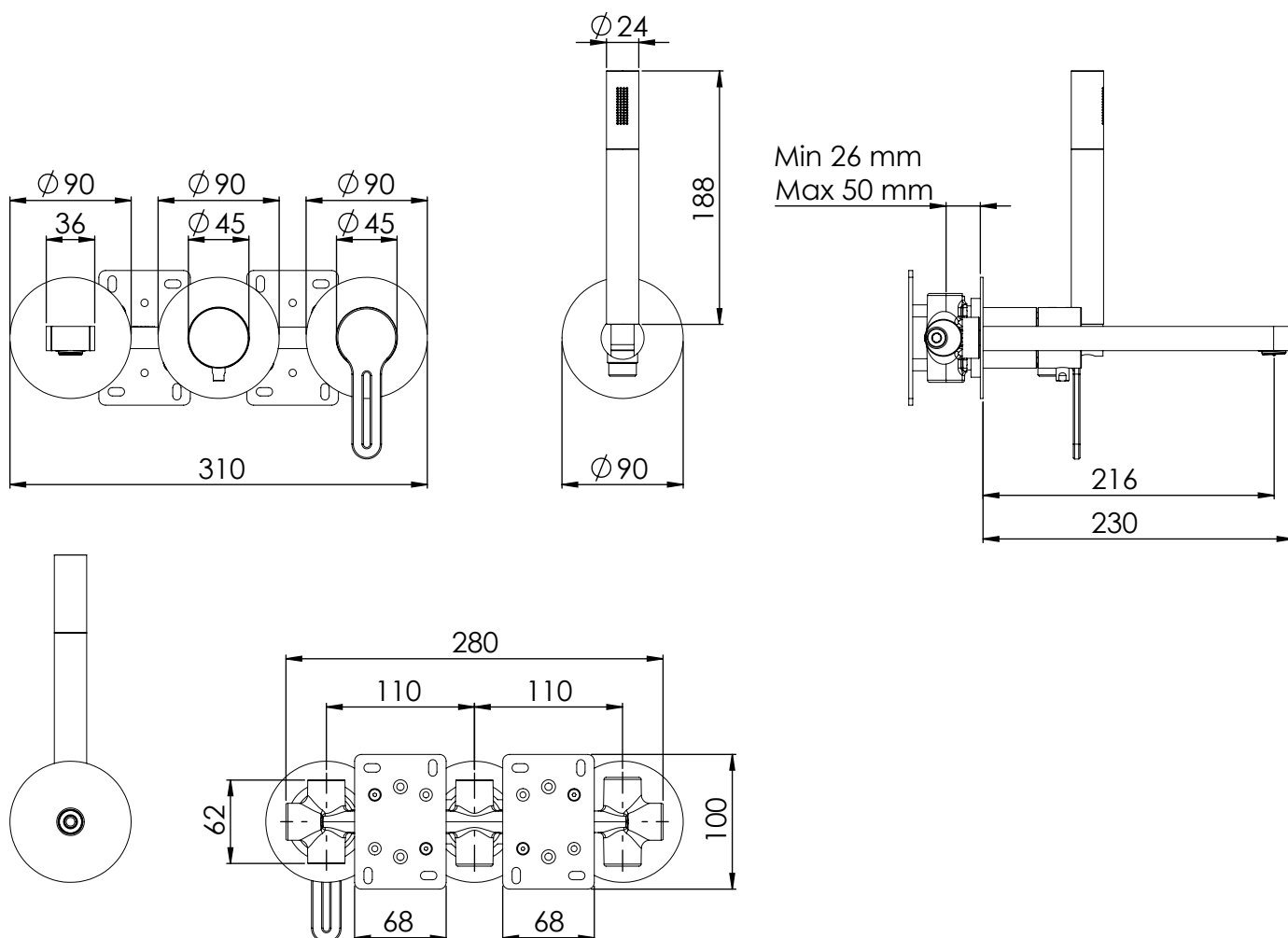

### MATERIALI / MATERIALS

OTTONE CROMATO / CHROME PLATED BRASS

### CROMATURA / CHROME PLATING

UNI EN 248

Via Leonardo da Vinci 53 20062 Cassano d'Adda (MI) Italy Tel. +39-0363 62651  
info@daniel.it www.daniel.it