

kreoo

Il Marmo è un materiale naturale, suscettibile a sensibili variazioni di colore. Quindi ogni singolo pezzo può presentare venature, differenze di tonalità, intrusioni minerali, avvallature e stuccature.

Marble is a natural material, sensitive to significant colour variations. Therefore each piece may have veins, colour differences, mineral intrusions, pores and grouting.



Texo



Panama

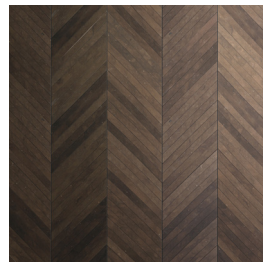

Hana 03 Left / Right



Hana 05



Merletto



Rondò



Fenice

Covering Collection

NOTE TECNICHE / TECHNICAL INFORMATION

Texo	- Spessore: 3,3 cm - Peso netto mattonella: 15 kg - Volume cassa: 115x80x100 cm	<i>Thickness: 3,3 cm Panel net weight: 15 kg Crate volume: 85x75x45 cm</i>
Panama	- Spessore: 2 cm - Peso netto mattonella: 9 kg - Volume cassa: 115x80x100 cm	<i>Thickness: 2 cm Net weight: 9 kg Crate volume: 115x80x100 cm</i>
Hana 03 Left/Right	- Spessore: 1 cm - Peso netto: 27 kg al mq - Volume cassa: 61x31x11 cm	<i>Thickness: 1 cm Panel net weight: 27 kg sqm Crate volume: 61x31x11 cm</i>
Hana 05	- Spessore: 1 cm - Peso netto: 27 kg al mq - Volume cassa: 56x56x35 cm	<i>Thickness: 1 cm Net weight: 19 kg sqm Crate volume: 56x56x35 cm</i>
Merletto	- Spessore: 2 cm - Peso netto: 20 kg - Volume cassa: 115x80x100 cm	<i>Thickness: 2 cm Panel net weight: 20 kg Crate volume: 115x80x100cm</i>
Rondò	- Spessore: 2 cm - Peso netto: 20 kg - Volume cassa: 115x80x100 cm	<i>Thickness: 2 cm Net weight: 20 kg Crate volume: 115x80x100 cm</i>
Fenice	- Spessore: 2cm - Peso netto: 20 kg - Volume cassa: 115x80x100 cm	<i>Thickness: 2 cm Net weight: 20 kg Crate volume: 115x80x100 cm</i>

kreoo

Il Marmo è un materiale naturale, suscettibile a sensibili variazioni di colore. Quindi ogni singolo pezzo può presentare venature, differenze di tonalità, intrusioni minerali, avvallature e stuccature.

Marble is a natural material, sensitive to significant colour variations. Therefore each piece may have veins, colour differences, mineral intrusions, pores and grouting.

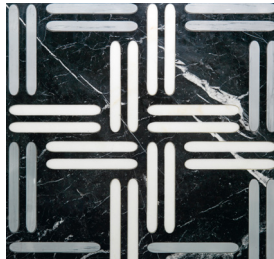

Weave



Alhambra



Rose



Baguette

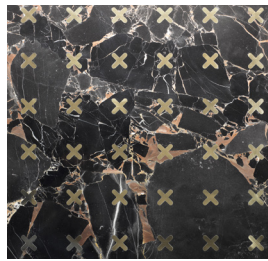

Étoile

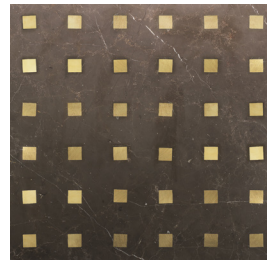

Carrè

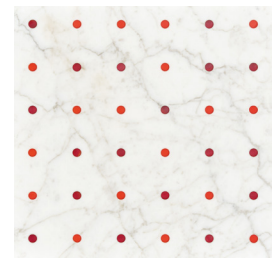

Pois

Covering collection

NOTE TECNICHE / TECHNICAL INFORMATION

Weave	- Spessore: 2 cm - Peso netto: 20 kg - Volume cassa: 115x80x100 cm	Thickness: 2 cm <i>Panel net weight: 20 kg</i> <i>Crate volume: 115x80x100 cm</i>
Alhambra	- Spessore: 2 cm - Peso netto: 20 kg - Volume cassa: 115x80x100 cm	Thickness: 2 cm <i>Panel net weight: 20 kg</i> <i>Crate volume: 115x80x100 cm</i>
Rose	- Spessore: 2 cm - Peso netto: 20 kg - Volume cassa: 115x80x100 cm	Thickness: 2 cm <i>Panel net weight: 20 kg</i> <i>Crate volume: 115x80x100 cm</i>
Ducale Collection		
Baguette	- Spessore: 2 cm	Thickness: 2 cm
Étoile	- Peso netto: 20 kg	<i>Panel net weight: 20 kg</i>
Carrè	- Volume cassa: 115x80x100 cm	<i>Crate volume: 115x80x100 cm</i>
Pois		

kreoo

Il Marmo è un materiale naturale, suscettibile a sensibili variazioni di colore. Quindi ogni singolo pezzo può presentare venature, differenze di tonalità, intrusioni minerali, avvallature e stuccature.

Marble is a natural material, sensitive to significant colour variations. Therefore each piece may have veins, colour differences, mineral intrusions, pores and grouting.



Fortune

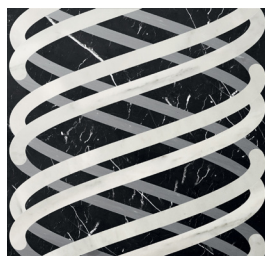

Twirl



Kaleidos



Waterlily

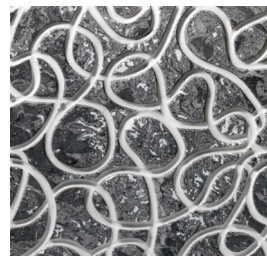

Picto

Covering collection

NOTE TECNICHE / TECHNICAL INFORMATION

Fortune	- Spessore: 2 cm - Peso netto: 20 kg - Volume cassa: 115x80x100 cm	Thickness: 2 cm <i>Panel net weight: 20 kg</i> <i>Crate volume: 115x80x100 cm</i>
Twirl	- Spessore: 2 cm - Peso netto: 20 kg - Volume cassa: 115x80x100 cm	Thickness: 2 cm <i>Panel net weight: 20 kg</i> <i>Crate volume: 115x80x100 cm</i>
Kaleidos	- Spessore: 2 cm - Peso netto: 20 kg - Volume cassa: 115x80x100 cm	Thickness: 2 cm <i>Panel net weight: 20 kg</i> <i>Crate volume: 115x80x100 cm</i>
Waterlily	- Spessore: 2 cm - Peso netto: 20 kg - Volume cassa: 115x80x100 cm	Thickness: 2 cm <i>Panel net weight: 20 kg</i> <i>Crate volume: 115x80x100 cm</i>
Picto	- Spessore: 2 cm - Peso netto: 20 kg - Volume cassa: 115x80x100 cm	Thickness: 2 cm <i>Panel net weight: 20 kg</i> <i>Crate volume: 115x80x100 cm</i>

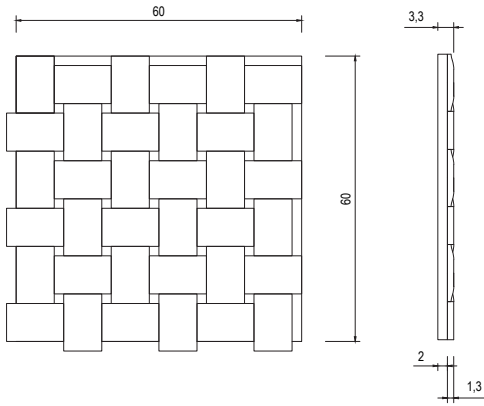

Texo

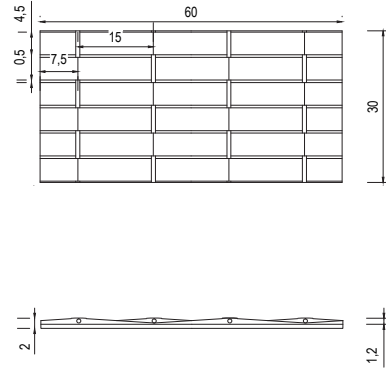

Panama

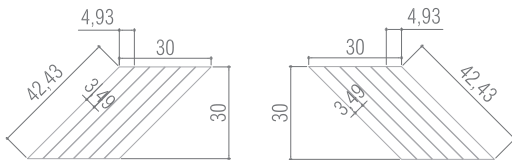

Hana 03 Left / Right

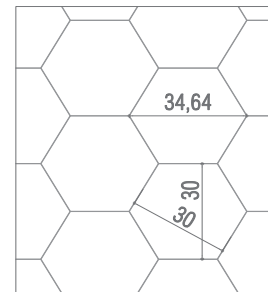

Hana 05

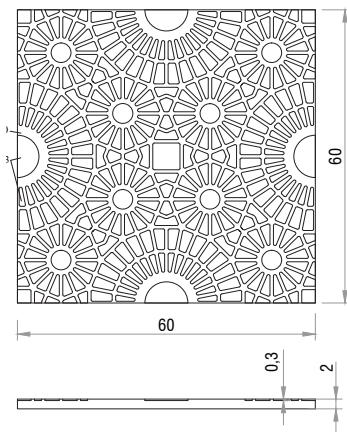

Merletto

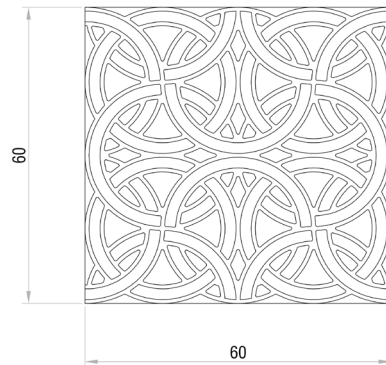

Rondò

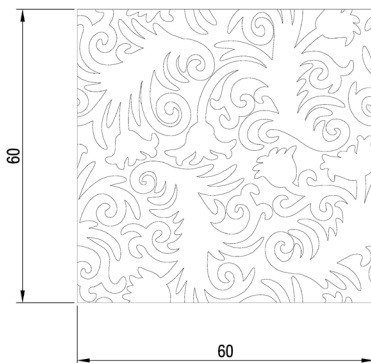

Fenice

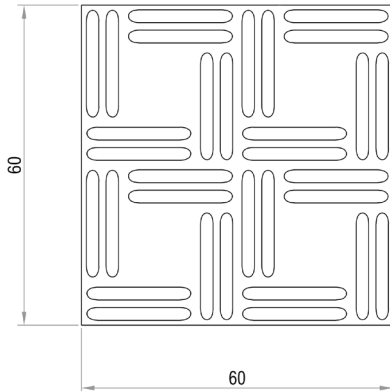

Weave

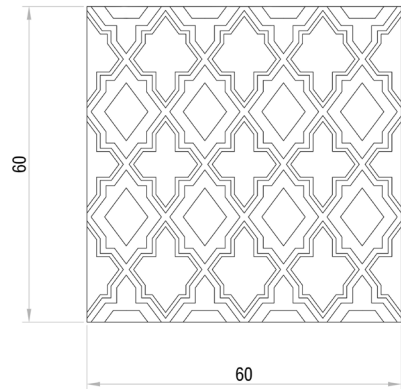

Alhambra

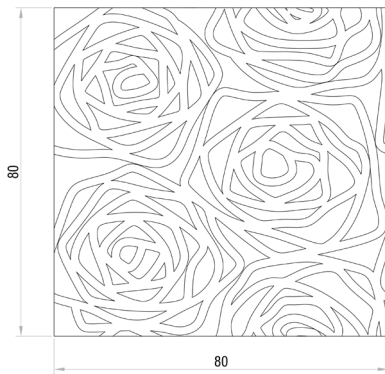

Rose

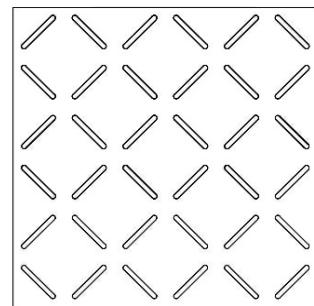

60
Baguette



60
Étoile

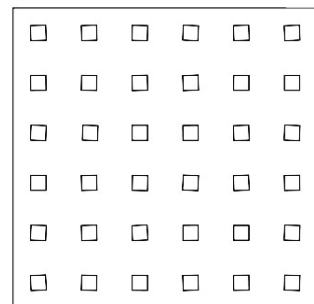

60
Carré

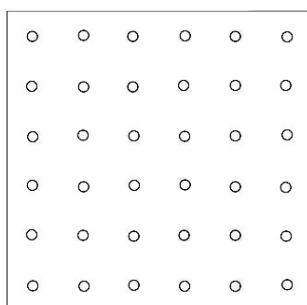

60
Pois

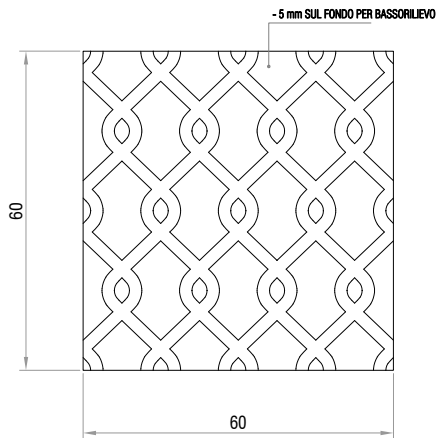

Fortune

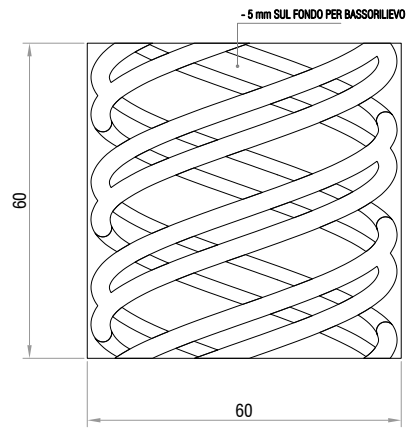

Twirl

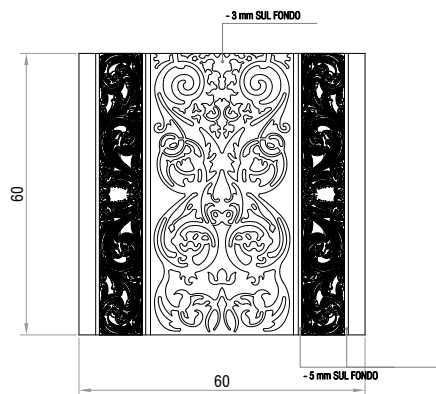

Kaleidos

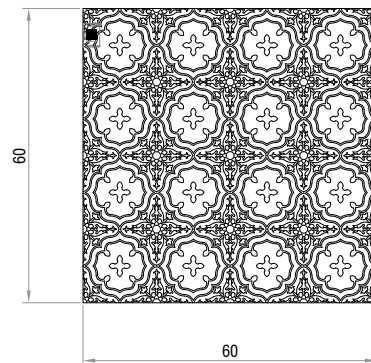

Waterlily

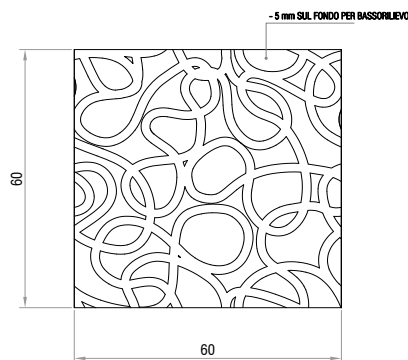

Picto

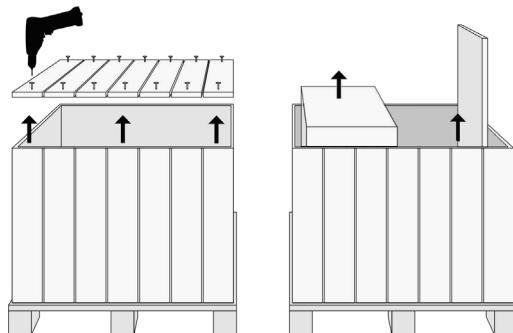

- 1 Aprire l'imballo svitando le assi sul lato indicato come "lato da aprire".
- 2 Rimuovere il pannello di apertura prendendolo nei punti indicati dalle frecce.

- 1 *Open up the crate by unscrewing the wooden boards on the opening side.*
- 2 *Remove the opening board on the indicated marks.*

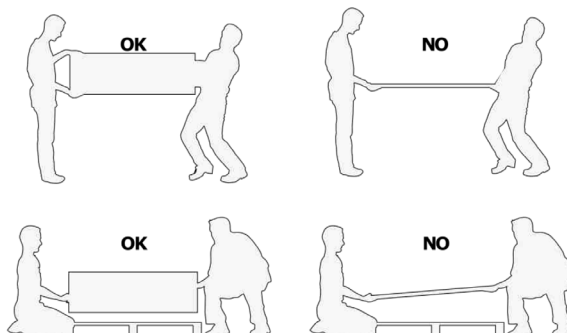

Nel maneggiare i prodotti, prestare attenzione a distribuire uniformemente il peso per evitare rotture.

When handling items, pay attention to distribute the weight proportionally to avoid breakage.

KIT PULIZIA / CLEANING KIT

PULIZIA QUOTIDIANA: pulire con normali detersivi di tipo neutro a basso contenuto alcalino. Si sconsiglia l'uso di prodotti aggressivi quali anti-calcare, acidi, abrasivi, sgrassanti, alcool.

PULIZIA STRAORDINARIA: quando si desidera ravvivare il colore del marmo si consiglia:
<http://www.kreoo.net/schedeprodotto/filastoneplus.pdf>

ORDINARY CLEANING: *clean with normal neutral detergents with low alkaline content. We do not recommend the use of aggressive products such as anti-lime, acids, abrasives, degreasers, alcohol.*

EXTRA-ORDINARY CLEANING: *to revitalise marble color we suggest*
<http://www.kreoo.net/schedeprodotto/filastoneplus.pdf>