

33 800 888



- 201mm projection
- pivotable spout 360°
- air-enriched flow
- height of mixer 325 mm
- height up to aerator 180 mm
- hole diameter 35 mm
- max. flow 7 l/min at 3 bar flow pressure
- lead-free
- WRAS 2311044
- This product can help a building meet the requirements of Green Building Rating Systems, e.g. LEED®, BREEAM®, DGNB

	Platinum	33 800 888-08
	Chrome	33 800 888-00
	Brushed Platinum	33 800 888-06
	Durabronze (23kt Gold)	33 800 888-09
	Dark Chrome	33 800 888-19
	Brushed Durabronze (23kt Gold)	33 800 888-28
	Matte Black	33 800 888-33
	Brushed Champagne (22kt Gold)	33 800 888-46
	Champagne (22kt Gold)	33 800 888-47
	Brushed Chrome	33 800 888-93
	Brushed Dark Platinum	33 800 888-99

Recommended miscellaneous

Strainer waste with control handle - Platinum 10 710 970-08



Recommended miscellaneous

Dispenser with rosette - Platinum 82 444 970-08



33 800 888

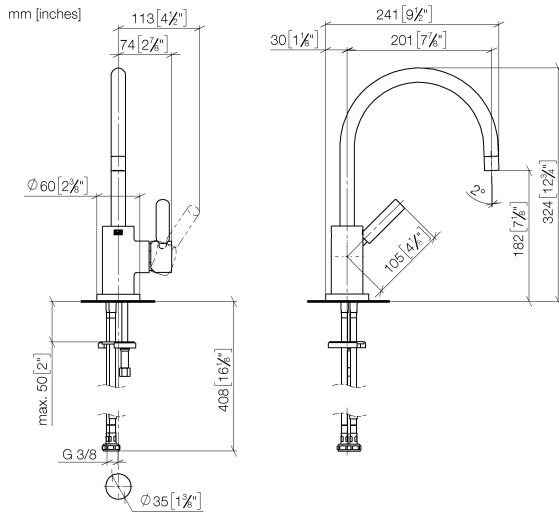

Flow rate chart



Codes & Standards

DIN 4109

EN 817

Executive Order
no. 1007

ISO 3822

Scottish Water
Byelaws

UK Water Supply
Regulations

Ü-Zeichen

VA-Zeichen



TARA Single-lever mixer - Platinum

TARA

33 800 888

Certificates

GDV_0400

ETA_18

LGA_8

WRAS_2311

33 800 888

Product version up to 5/31/2010

Product version from 5/31/2010 to 10/27/2020

Product version from 10/27/2020 to 9/7/2021

Product version from 9/1/2021

Parts for other finishes can be found here: [Chrome](#)

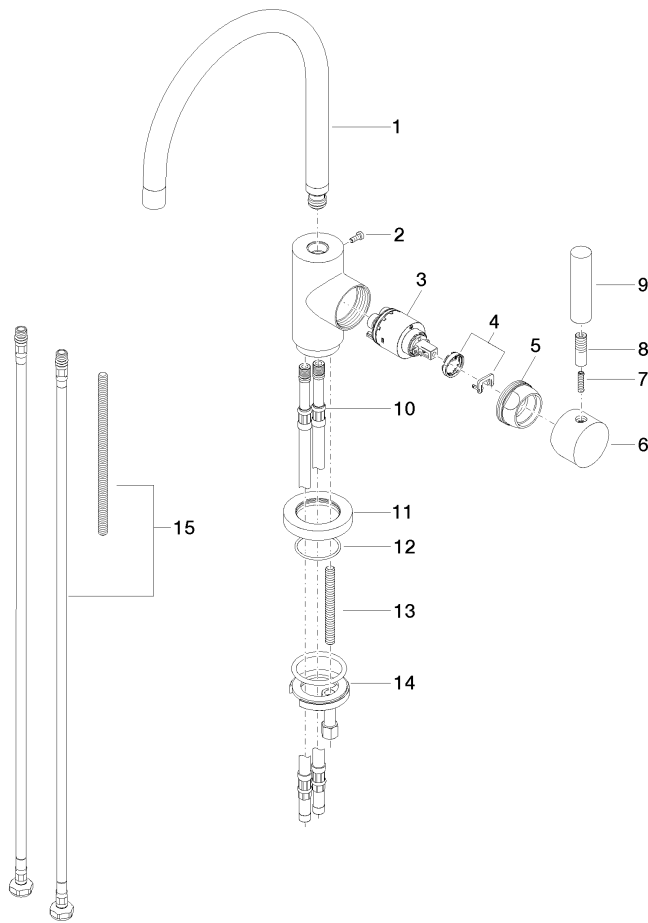



TARA Single-lever mixer - Platinum

TARA

33 800 888

Spare parts list

Product version up to 5/31/2010

Product version from 5/31/2010 to 10/27/2020

Product version from 10/27/2020 to 9/7/2021

Product version from 9/1/2021

No.	Item Number	Name	Quantity used	Delivery time
	90 28 22 048 02-08	spout	16	40