

Ø120

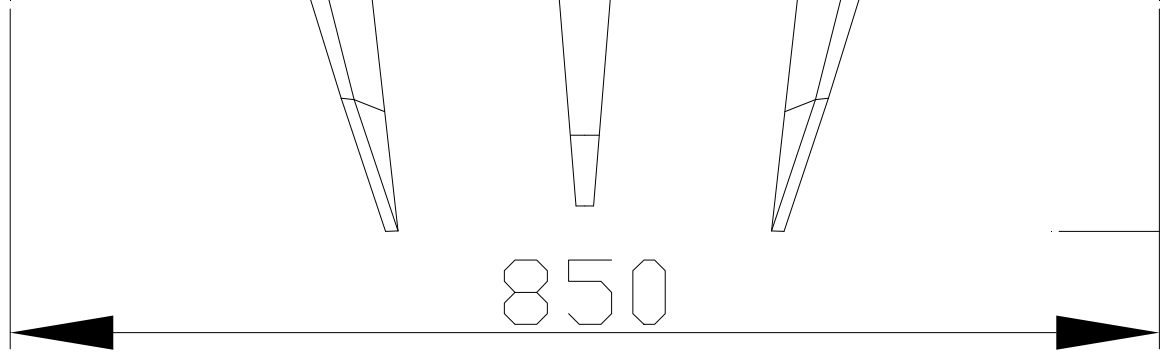
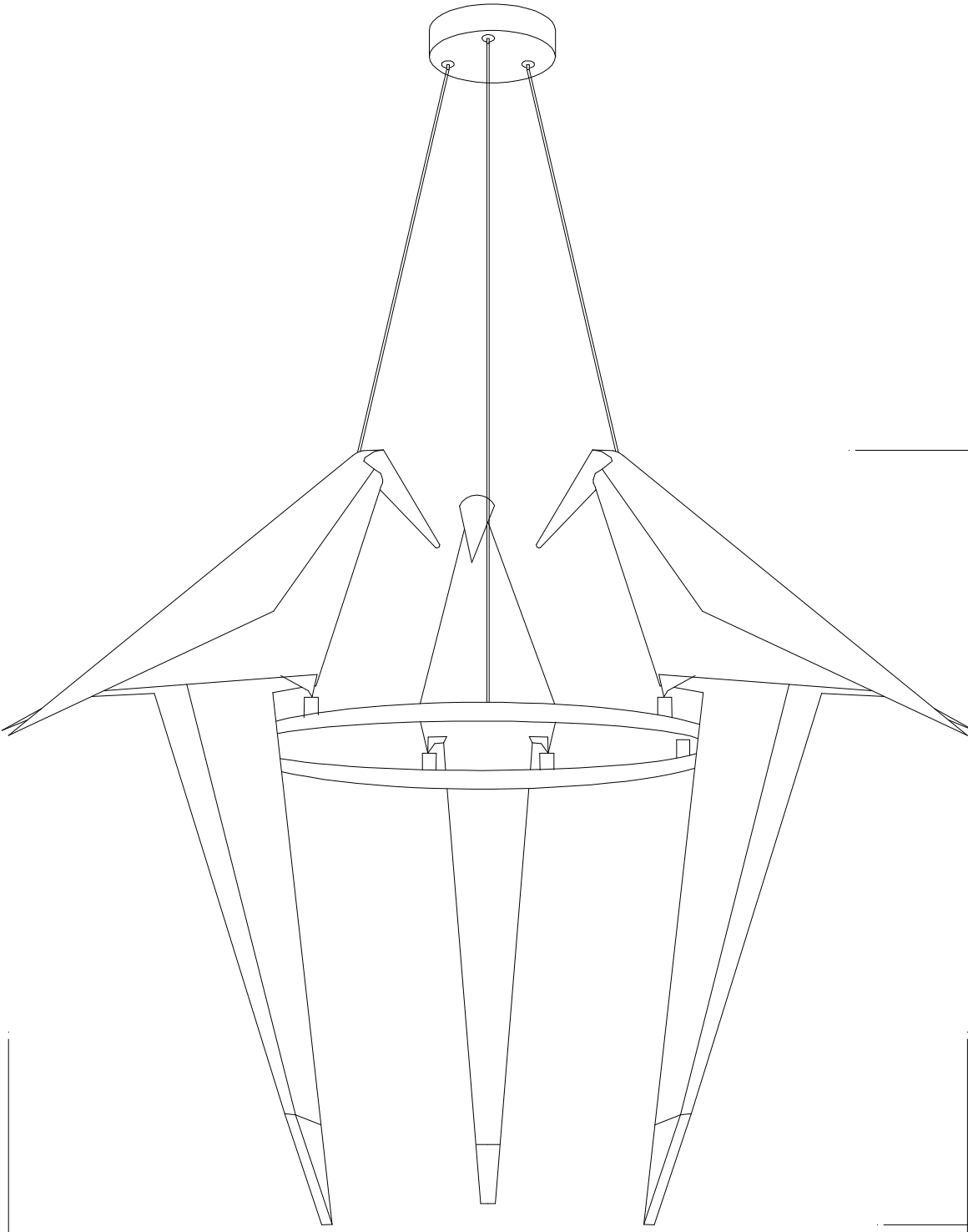

850

650