



RICAMBI / SPARE PARTS

Stresa

Art. 1440 - 1440/1 - 1432/2 - 1640 - 1640/1 - 1632/2

Art. 1440-1640

Art. 1432/2
1632/2

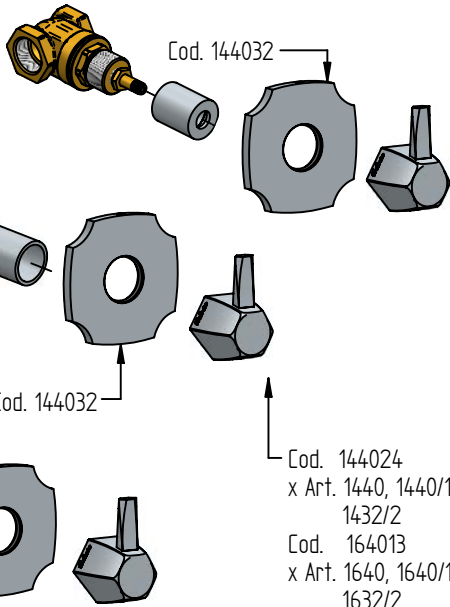

COD. 654067



COD. 144024



COD. 164013

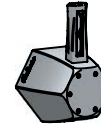

COD. 144032



Cod. 144024
x Art. 1440, 1440/1
1432/2
Cod. 164013
x Art. 1640, 1640/1
1632/2

Art. 1440/1
1640/1

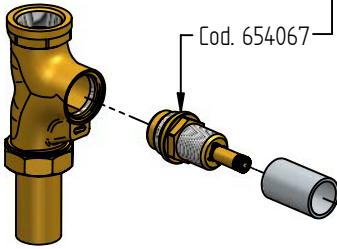

Art. 1440

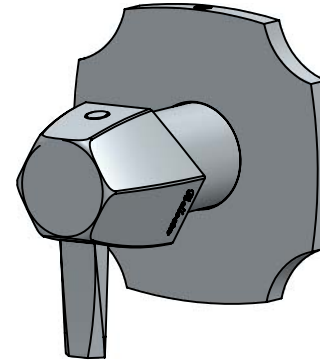

Art. 1640

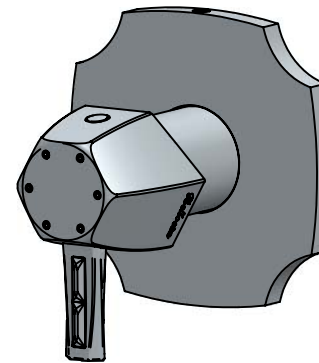

Art. 1440/1

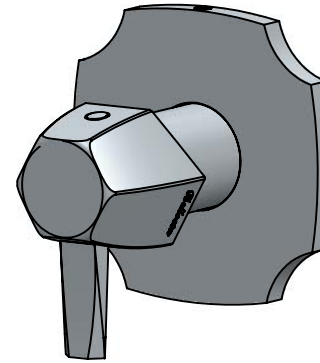

Art. 1640/1

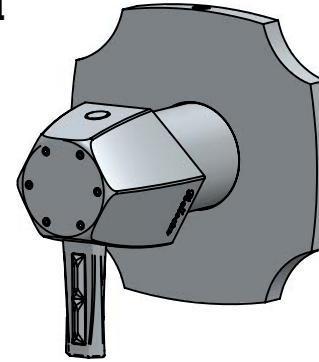

Art. 1432/2

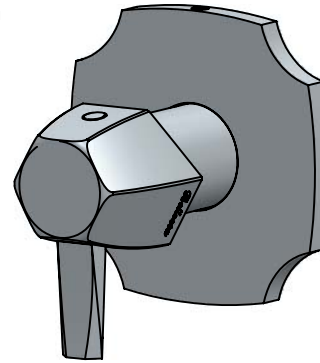

Art. 1632/2

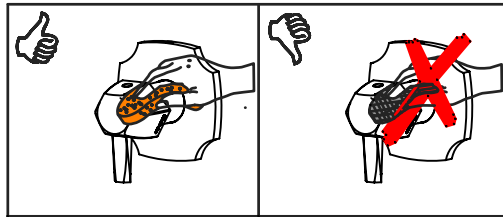
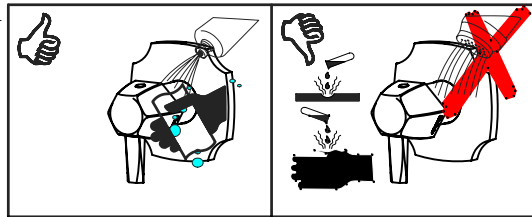
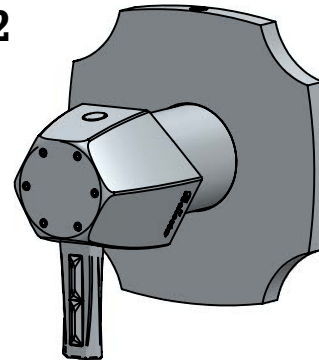

MANUTENZIONE E PULIZIA

Per una corretta manutenzione e pulizia di questo prodotto, raccomandiamo alcuni semplici accorgimenti:

- Utilizzare **detergenti neutri**, spruzzando il prodotto direttamente su un panno morbido onde evitare infiltrazioni
- Evitare **sempre** il contatto con prodotti acidi o abrasivi
- **Risciacquare bene** con abbondante acqua per eliminare eventuali residui ed **asciugare sempre** con un panno morbido
- Effettuare una **pulizia periodica** al fine di prevenire le formazioni calcaree

La BELLOSTA CARLO & C. non è RESPONSABILE di danni derivati dall'utilizzo di prodotti impropri per la pulizia.

MAINTENANCE AND CLEANING

For a proper maintenance and cleaning, we recommend the following:

- Use **neutral detergents**, avoiding to spray directly on taps to avoid residual infiltration
- **Avoid** contact with acid or abrasive products
- **Rinse** with water and **always dry** with a clean cloth to avoid residue of detergent
- Perform a **periodic cleaning** to prevent limestone deposits

BELLOSTA CARLO & C. cannot be held responsible for damages due to an improper use of detergents

ISO 9001
ISO 9001-2000
SCQ
B.I. 06/06
> ufficio tecnico BELLOSTA

MADE IN ITALY

DESIGN
EOB

MADE IN ITALY

This product has been entirely manufactured in Italy, by top quality raw materials.



D

MADE IN ITALY

This prodotto è stato realizzato interamente in Italia con l'utilizzo di materie prime di altissima qualità

DESIGN
EOB

MADE IN ITALY

This product has been entirely manufactured in Italy, by top quality raw materials.



Rubinetti d'autore dedicati a te

ISTRUZIONI DI INSTALLAZIONE-INSTALLATION INSTRUCTION

ART. 1440,1640



VERIFICARE CHE IL PASSAGGIO DI SFOGO SIA LIBERO

(ART.1440, 1640) IN 3/4"

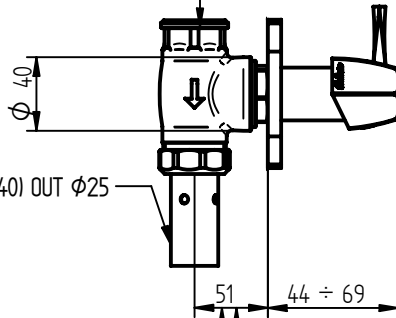

(ART.1440, 1640) OUT $\phi 25$

DA 39mm A 64mm E' LO SCOSTAMENTO CONSIDERATO A MURO FINITO COMPRESIVO DI RIVESTIMENTO

MISURA IDEALE A MURO FINITO COMPRESIVO DI RIVESTIMENTO

ART. 1440/1, 1640/1



VERIFICARE CHE IL PASSAGGIO DI SFOGO SIA LIBERO

(ART.1440/1, 1640/1) IN 1"

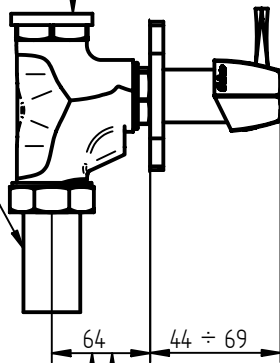

(ART.1440/1, 1640/1) OUT $\phi 30$

DA 52mm A 77mm E' LO SCOSTAMENTO CONSIDERATO A MURO FINITO COMPRESIVO DI RIVESTIMENTO

MISURA IDEALE A MURO FINITO COMPRESIVO DI RIVESTIMENTO

ART. 1432/2 1632/2

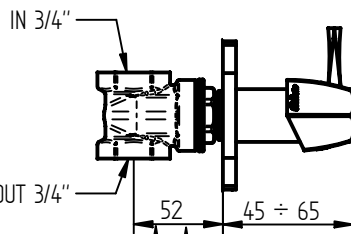

OUT 3/4"

DA 42mm A 62mm E' LO SCOSTAMENTO CONSIDERATO A MURO FINITO COMPRESIVO DI RIVESTIMENTO

MISURA IDEALE A MURO FINITO COMPRESIVO DI RIVESTIMENTO

ATTENZIONE!

Per il corretto funzionamento dell'articolo l'alimentazione dello stesso deve essere equi-dimensionata

LA BELLOSTA RUBINETTERIE NON RISponderA' IN CASO DI ERRATA INSTALLAZIONE DELL'ARTICOLO

ATTENTION!

In order to obtain a properly functioning, the feeding of the article must have the same dimensions as the related connected parts

BELLOSTA RUBINETTERIE WILL NOT RESPONSE IN CASE OF INCORRECT INSTALLATION OF ARTICLE

SOSTITUZIONE VITONE ART. 1440 - 1640 - 1440/1 - 1640/1

1

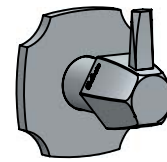

Aiutarsi con uno spillo per estrarre il tappino / Use pin to extract cap

2

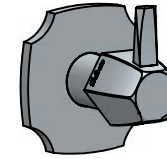

2,5

3

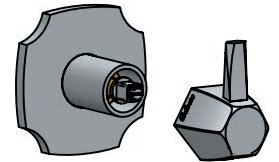

4

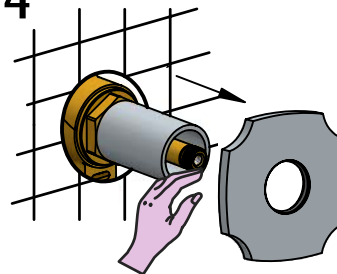

5

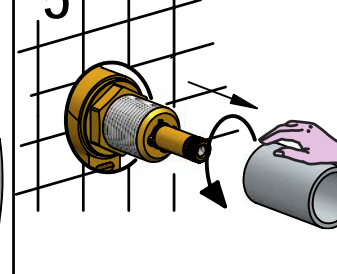

6

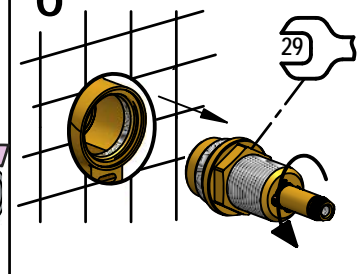

NOTE DI INSTALLAZIONE ART. 1432/2 - 1632/2

1

Regolare la portata desiderata/
Regulate the chosen water capacity

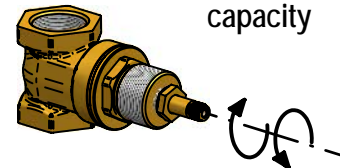

2

Inserire la maniglia con leva verso l'alto/Insert the handle on the disc carefully installing the lever towards the high

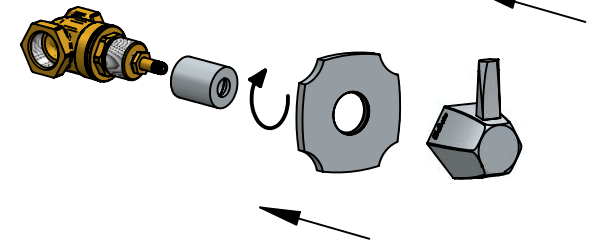

Per qualsiasi richiesta di informazioni, preghiamo contattare l'Ufficio Tecnico presso: info@bellostarubinetterie.com

For any technical inquiries, please contact the Technical Office at: info@bellostarubinetterie.com