

Nicolazzi

Art. 4909--27

28010 ALZO (NO) via P.Durio 119 Tel. 0322-969672 Fax 0322-969532 www.nicolazzi.it info@nicolazzi.it

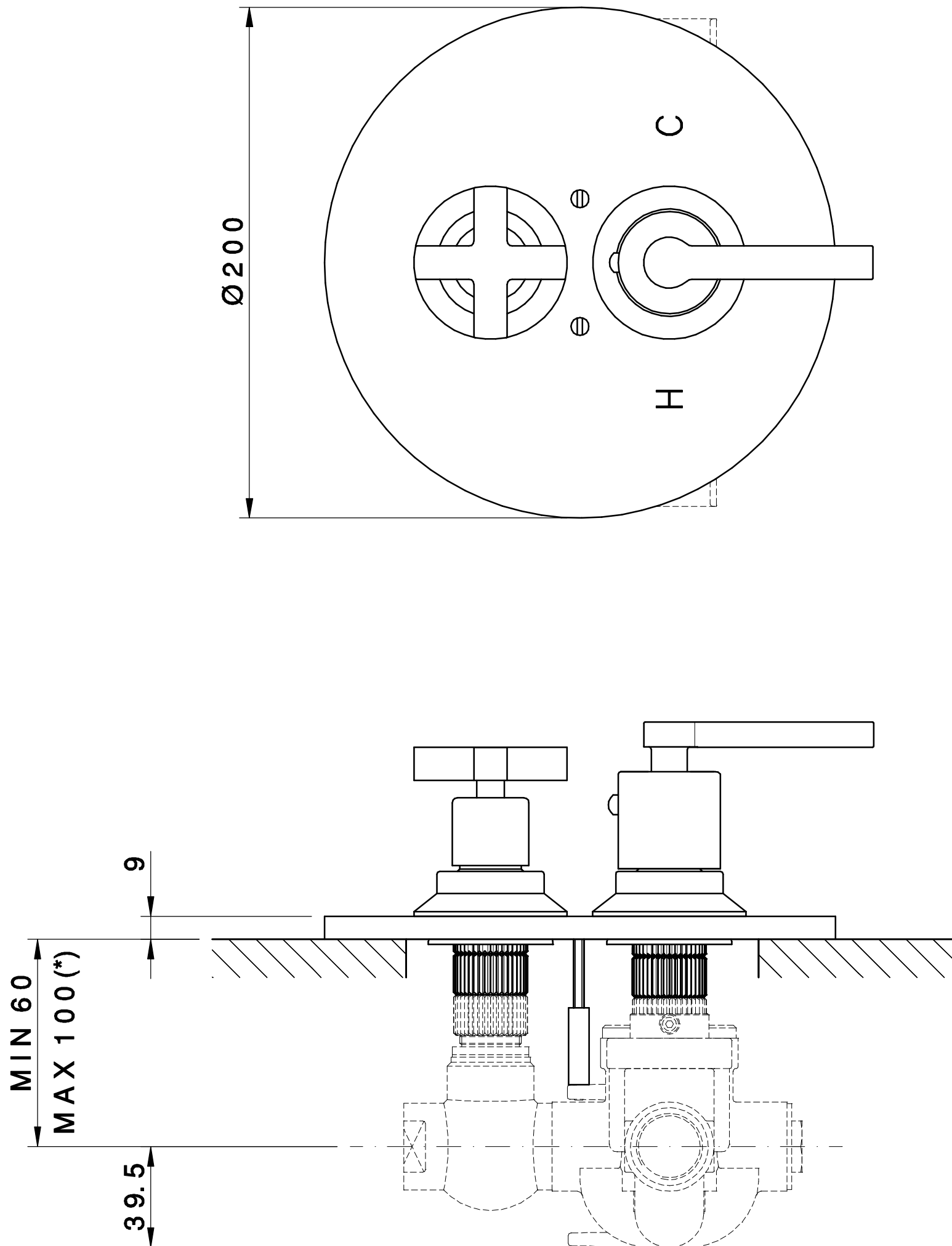

(*) = Disponibile kit di prolunga h.20 mm cad.
Available extensions kit h.20 mm. each

INSTALLATION THE TRIM PLATE 4909

Note: The trim is assembled out of the box. The only loose parts are:

1. The finished screws for installation of the plate C7539.
2. The trim plate gasket C7921.
3. The C7913SET extension kit.

Installation:

1. Install the screw extension C7914 or 11.
2. Install the C7913SET as shown or 10B with the spring C7597.2 or 10A.
3. Remove the adhesive backing and install the gasket C7921 to the back of the faceplate.
4. Verify the red dot on the C7919 or 13b is lined up with the red dot on the body of the valve. Not pictured.
- a. Please note: this is the most common fault of installation. Verify the cartridge is at the correct position. Re-set the cartridge if you are unsure of the correct setting.
5. Put the LOWER Thermostatic lever 9b at 6 O'clock on the face plate 7.
6. Put the UPPER volume lever 9a at 12 O'clock on the face plate 7.
7. Place the faceplate on the valve with the appropriate extensions from C7913SET if necessary on the brass spindle. This is determined by the valve depth in the wall. Not all extensions may be necessary.
8. Install the screws C7539 or 8.
9. Test the valve

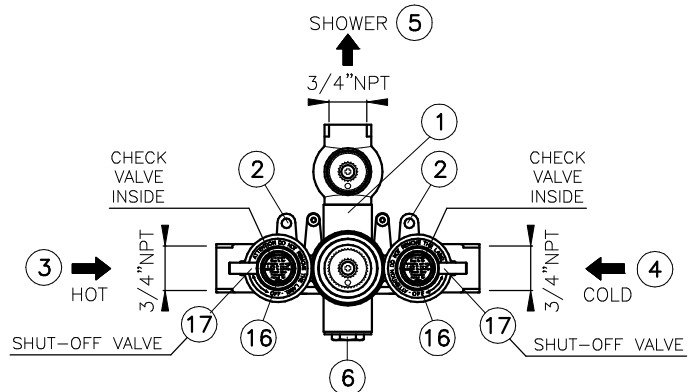
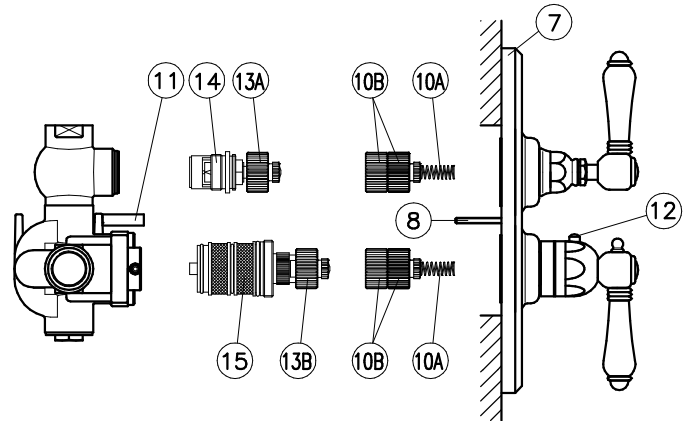

OPERATION OF VALVE

- WITH THE HANDLE IN THE 6 O'CLOCK POSITION (9B), THE VALVE SHOULD RUN AT 100.4 F. (38 °C).
- PUSHING THE HOT LIMIT STOP (12) IN AND ROTATING THE HANDLE COUNTER CLOCKWISE, THE WATER WILL GET WARMER.
- MOVING THE HANDLE CLOCKWISE WILL PRODUCE COOLER WATER.

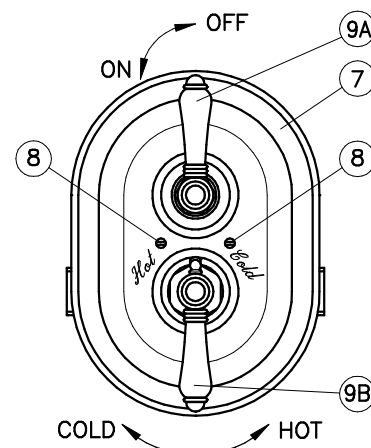

CARE AND MAINTENANCE

Cleaning the filtration system

- i. To clean the filters if there is low flow or low temperature:
 1. Set the volume control to off or 12 o'clock.
 2. Place the lower thermostatic lever at 6 o'clock.
 3. Remove the plate by removing the 2 screws C7539. Be careful to retain all parts.
 4. Turn the hot and cold supplies off: See "Using the service stops".
 5. Remove the inner nut to extract the filter.
 6. Flush the filters.
 7. Flush the lines to remove any debris.
 8. Reverse the steps to re-assemble.

Changing the volume control cartridge

- i. To change the volume control cartridge:
 1. Set the volume control to off or 12 o'clock.
 2. Place the lower thermostatic lever at 6 o'clock.
 3. Remove the plate by removing the 2 screws C7539. Be careful to retain all parts.
 4. Turn the hot and cold supplies off: See "Using the service stops".
 5. Remove the volume control cartridge.
 6. Install the new volume control cartridge.
 7. Reverse the steps to re-assemble.

Changing thermostatic control cartridge

- i. To change the thermostatic control cartridge:
 1. Set the volume control to off or 12 o'clock.
 2. Place the lower thermostatic lever at 6 o'clock.
 3. Remove the plate by removing the 2 screws C7539. Be careful to retain all parts.
 4. Turn the hot and cold supplies off: See "Using the service stops".
 5. Remove the thermostatic control cartridge.
 6. Install the new thermostatic cartridge.
 7. Turn the hot and cold supplies on: See "Using the service stops".
 8. To calibrate the thermostatic cartridge:
 - a. With the faceplate off, turn the volume control on to one of the functions.
 - b. With a thermometer, turn the cartridge control counter clockwise until you get 100.4 degrees Fahrenheit (38 °C) at the outlet. Do not over twist the cartridge. There are internal stops that can be broken if it is turned beyond the stop.
 - c. Turn the water off.
 9. Reverse the steps to re-assemble.