

Art: 3089

Válvula de esfera para tubería PE / Ball valve for PE pipe

Características	Features
1. Válvula de esfera con paso total.	1. Ball valve with full bore.
2. Presión máxima de trabajo 25 bar (PN 25).	2. Maximum working pressure 25 bar (PN 25).
3. Construcción en latón s/ UNE-EN 12165.	3. Brass according to UNE-EN 12165.
4. Un extremo rosca gas (BSP) hembra s/ ISO 228/1 y otro para conexión a tubería mediante sistema Rac-GE.	4. One end gas (BSP) female thread acc./ ISO 228/1 and another for pipe connection through Rac-GE system.
5. Accionamiento mediante palanca de acero.	5. Working by means of steel lever handle.
6. Temperatura de trabajo desde -20°C a 110°C.	6. Working temperature from -20°C to 110°C.
7. Aplicable para la unión de tubo de polietileno de baja, media y alta densidad.	7. Adaptable for polyethylene pipes (PE) joint of low, medium and high density.

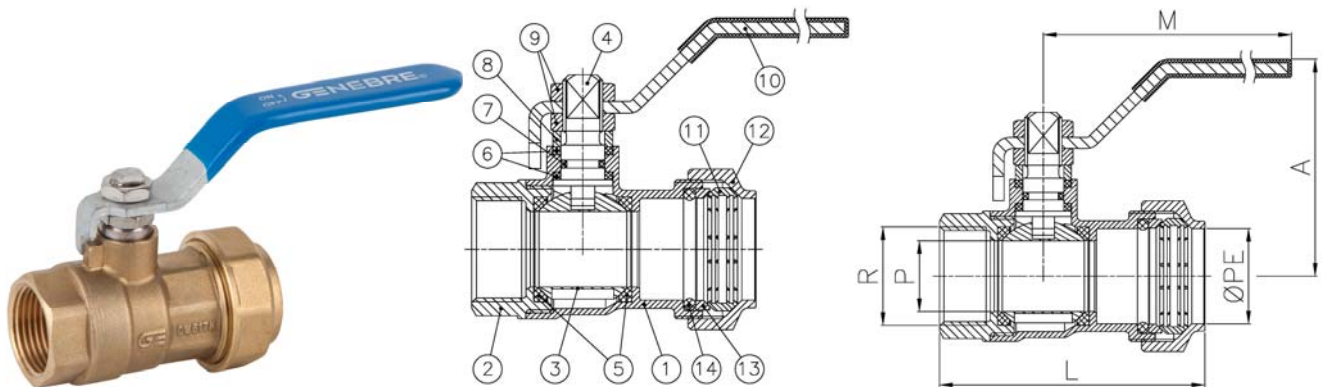

Nº	Denominación / Name	Material	Acabado Superficial / Surface Treatment
1	Cuerpo / Body	Latón / Brass (CW617N)	Granallado / Peened
2	Tapa / Cap	Latón / Brass (CW617N)	Granallado / Peened
3	Esfera / Ball	Latón / Brass (CW617N)	Cromado / Chrome plated
4	Eje / Stem	Latón / Brass (CW617N)	Cromado / Chrome plated
5	Asientos / Ball seats	PTFE	-
6	Anillo prensa / Stem packing	PTFE	-
7	Tórica / O-Ring	NBR	-
8	Anillo prensa / Stem ring	Latón / Brass	Cromado / Chrome plated
9	Tuerca / Nut	Latón / Brass	Cromado / Chrome plated
10	Maneta / Handle	Acero / Steel	Dacromet / Dacromet
11	Anillo apriete / Necking	Latón / Brass (CW617N)	Cromado / Chrome plated
12	Tapa / Cap	Latón / Brass (CW617N)	Granallado / Peened
13	Anillo tope / Washer ring	Latón / Brass (CW617N)	Cromado / Chrome plated
14	Junta tórica / O-ring	NBR	-

Ref.	DN	Dimensiones / Dimensions (mm)					Peso / Weight (Kg)	
		R	ØPE	P	A	L		
3088 04	15	1/2"	20	14	47	61	84	0,195
3088 05	20	3/4"	25	19	58	71	98	0,325
3088 06	25	1"	32	24	61	86	98	0,490

DIAGRAMA PÉRDIDA DE CARGA / HEAD LOSS CHART

(Válvulas paso total roscadas / Threaded ends full bore ball valves)

Valores de Kv / Kv Values:

Kv = Es la cantidad de metros cúbicos por hora que pasará a través de la válvula generando una pérdida de carga de 1 bar.

Kv = The flow rate of water in cubic meters per hour that will generate a pressure drop of 1 bar across the valve.

Medida / Size	1/2"	3/4"	1"
Kv	24	43	83

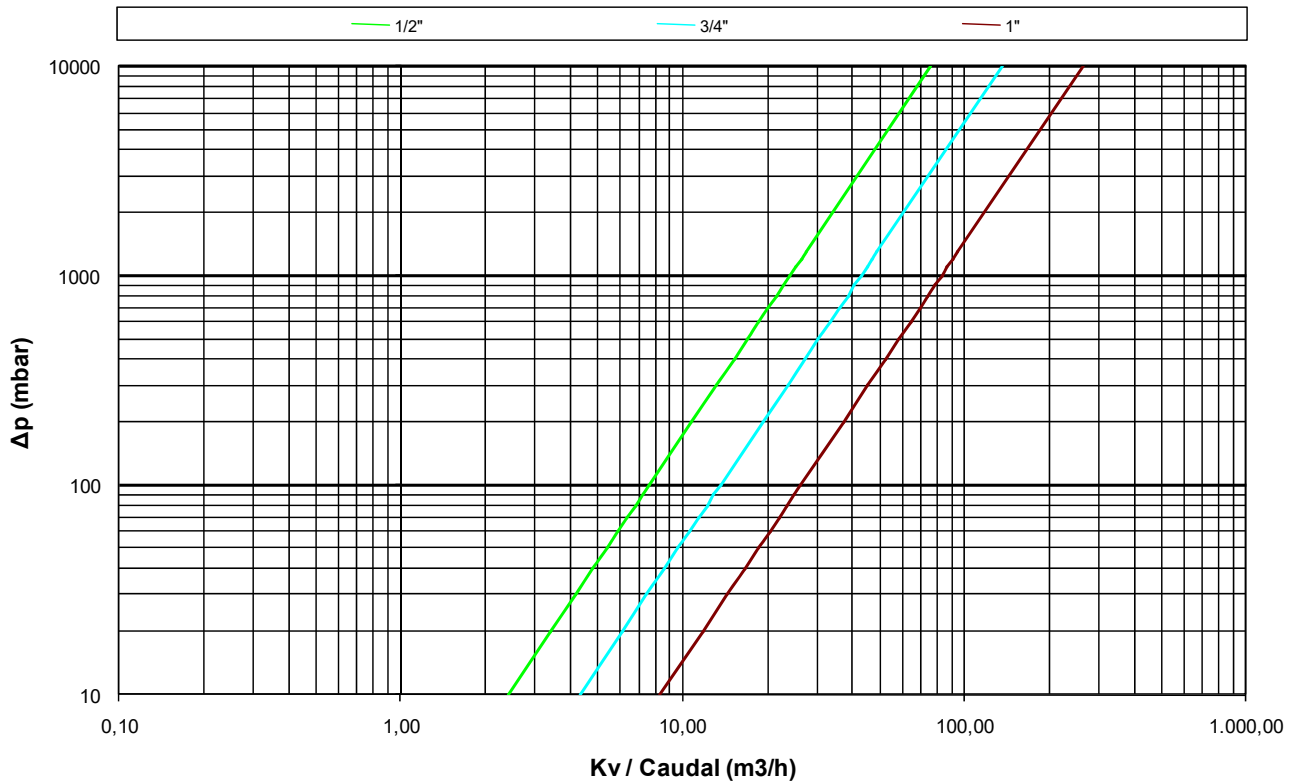

CURVA PRESIÓN - TEMPERATURA / PRESSURE - TEMPERATURE RATING

