







33 521 671



- 129mm projection
- fixed spout
- rectangular, air-enriched flow
- height of mixer 138 mm
- height up to aerator 71 mm
- hole diameter 35 mm
- 2x screw-in M 10 x 1 pressure hose, leak-tested
- max. flow 4.6 l/min
- lead-free
- This product can help a building meet the requirements of Green Building Rating Systems, e.g. LEED®, BREEAM®, DGNB

	Brushed Chrome	33 521 671-93
	Chrome	33 521 671-00
	Brushed Platinum	33 521 671-06
	Dark Chrome	33 521 671-19
	Brushed Light Gold	33 521 671-27
	Matte Black	33 521 671-33
	Brushed Dark Platinum	33 521 671-99

33 521 671

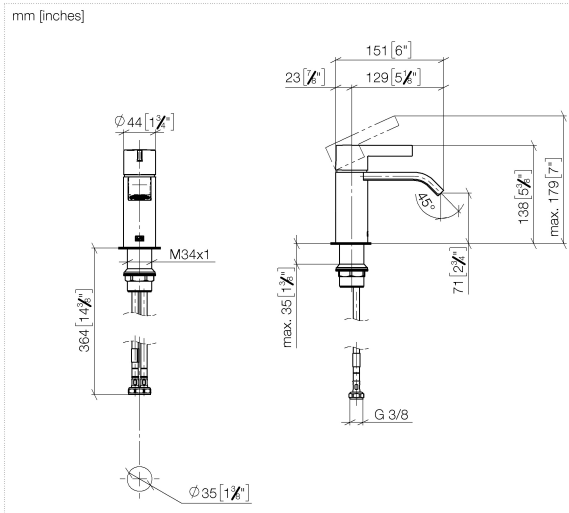

Flow rate chart

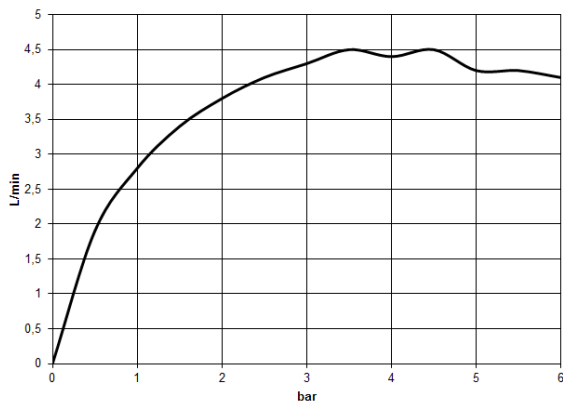

Codes & Standards

DIN 4109

ISO 3822

Ü-Zeichen



## IMO Single-lever basin mixer without pop-up waste - Brushed Chrome

---

IMO

33 521 671

Certificates

---

LGA\_19

33 521 671

**Product version from 4/1/2024**

Parts for other finishes can be found here: [Chrome](#)

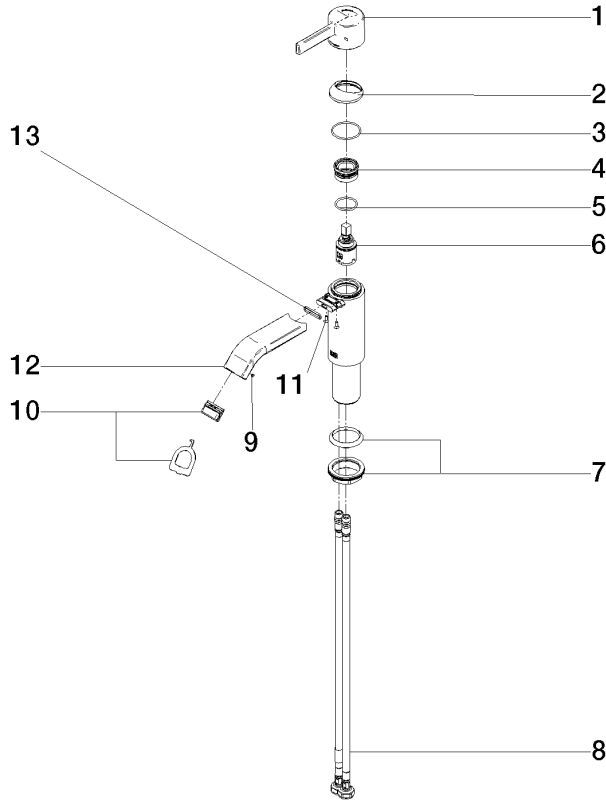



IMO Single-lever basin mixer without pop-up waste - Brushed Chrome

IMO

33 521 671

**Spare parts list**

**Product version from 4/1/2024**

No.	Item Number	Name	Quantity used	Delivery time
	90 20 67 019 00-93	handle	15	20