

Features

- Low-threshold design for easy entry and exit.
- Single threshold for three-wall installation.
- Durable plastic construction.
- Integral 18-inch undercut seat at right.
- Coordinates with other products in the Tresham collection.

Material

- Acrylic.

Installation

- Left drain.



Recommended Products/Accessories

K-1733 9 kW Steam Generator
K-702206-G54 Frameless Sliding Shower Door
K-702206-G73 Frameless Sliding Shower Door
K-702206-L Frameless Sliding Shower Door
K-702207-L Frameless Sliding Shower Door
K-702217-L Frameless Sliding Shower Door
K-705705-L Frameless Pivot Shower Door
K-705711-L Frameless Pivot Shower Door
K-705717-L Frameless Pivot Shower Door
K-705723-L Frameless Pivot Shower Door
K-705729-L Frameless Pivot Shower Door
K-705741-L Frameless Pivot Shower Door
K-705824-L Semi-Frameless Pivot Shower Door
K-705825-L Semi-Frameless Pivot Shower Door
K-706009-D3 Frameless Sliding Shower Door
K-706009-L Frameless Sliding Shower Door
K-706012-L Frameless Sliding Shower Door
K-706013-L Frameless Sliding Shower Door
K-706015-D3 Frameless Sliding Shower Door
K-706015-L Frameless Sliding Shower Door
K-706019-L Frameless Sliding Shower Door
K-9132 Shower Drain
K-23726 Drain treatment
K-23732 Tub & shower cleaner

Codes/Standards







CSA B45.5/IAPMO Z124
ASTM E162
ASTM E662

KOHLER® Plastic Baths and Receptors Lifetime Limited Warranty

See website for detailed warranty information.

Available Colors/Finishes

Color tiles intended for reference only.

Color	Code	Description
	0	White
	96	Biscuit
	47	Almond
	NY	Dune
	95	Ice™ Grey
	G9	Sandbar

60" single-threshold shower base with integral seat K-1977

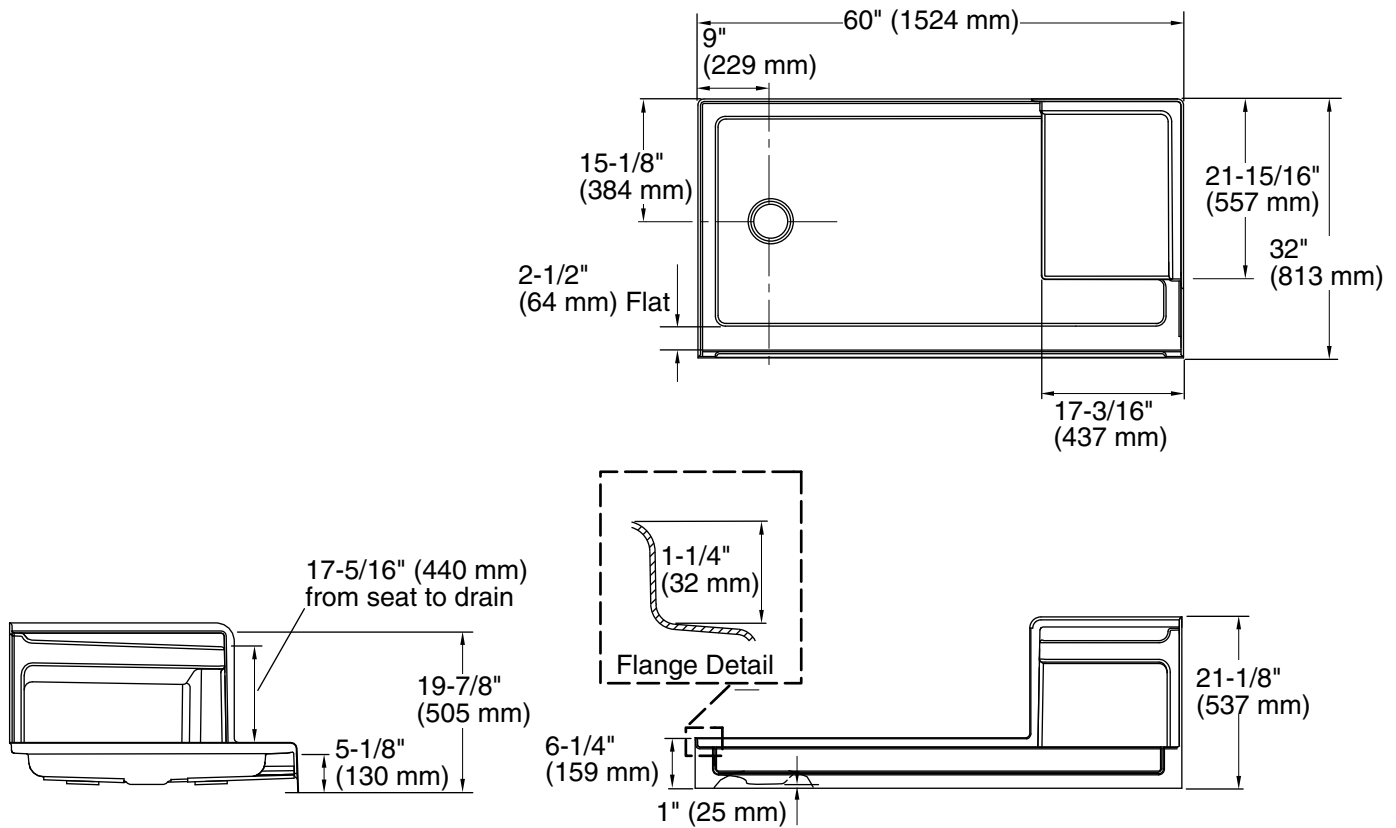

Technical Information

All product dimensions are nominal.

Installation:	Three-wall alcove
Drain location:	Left
Weight:	72 lbs (32.7 kg)
Minimum floor load:	20 lbs/ft ² (97.6 kg/m ²)

Notes

Measure your actual product for rough-in details.

Install this product according to the installation instructions.

Shimming may be required between the stud frame and the fixture.

Stud opening tolerance is +1/4" (6 mm), -0" (0 mm).

KOHLER steam generator/control kit are designed for use with this product. Kohler Co. shall not be responsible for problems encountered due to the installation and use of other manufacturer's steam generators.