



# V.01 CATALOGO ALIAS



# ALIAS SOFT SEATING

Design by Vaghi R&D

Sedute per l'attesa:  
una concezione  
intelligente  
improntata  
alla semplicità,  
flessibilità,  
modularità,  
comfort ed alla  
valorizzazione  
degli spazi.

**EN** Modular soft seating: its intelligent concept is driven by simplicity, flexibility, modularity, comfort and improvement of space.

**FR** Sièges modulaires: dont concept particulièrement intelligent est basé sur la simplicité, la flexibilité, la modularité, le confort et la valorisation des espaces.

**ES** Asientos modulares: su concepto inteligente es impulsado por la simplicidad, la flexibilidad, la modularidad, el confort y el deseo de la valorización de el espacio.



Configura la tua seduta /  
Set up your chair





AS2ML - AS1ML < AS1MB A



5100









AS20W < AS10B A

ATTESE WAITING  
ALIAS SOFT SEATING



AS1DB ▲ PM09F - PM06F - PM12F >







AS1SB + ATRBB - AS1DB + AS2DB - AS1DB - AS2SB

ATTESE WAITING  
ALIAS SOFT SEATING

AS1MB



AS2MB



POLTRONA E DIVANO ARMCHAIR AND SOFA

AS10B



AS20B



AS30B



POLTRONA E DIVANO ARMCHAIR AND SOFA

AS10W



AS20W



POLTRONA E DIVANO ARMCHAIR AND SOFA

AS1DB



AS2DB+ATRBB



AS1SB



AS2SB + ATRBB



SEDUTE MODULARI ASIMMETRICHE ASYMMETRIC MODULAR SEATING

PM06F



PM09F



PM12F



POUF OTTOMAN

## MODELLI DISPONIBILI AVAILABLE MODELS

### AM/AS

Poltrona e divano / Armchair and sofa / Fauteuil et canapé / Sillón y sofá

### ASM

Sedute modulari asimmetriche / Asymmetric modular seating / Sièges modulaires asymétriques / sillas modulares asimétricas

### PM

Pouf / Ottoman / Poufs / Pufs

## CERTIFICAZIONI CERTIFICATIONS

EN 16139 EN 1022 EN 1728 Test by CATAS

Omologazione Ministeriale in Classe 1IM

## FINITURE FINISHES

### PARTI METALLICHE METAL PARTS

Cromato, verniciato nero, bianco (RAL 9016) o tortora (RAL 1019) / Chromed, black, white (RAL 9016), dove grey (RAL 1019) painted / Chrome, verni couleur noir, blanc (RAL 9016) ou gris tourterelle (RAL 1019) / Cromo, acabado en negro, blanco (RAL 9016) o gris tórtola (RAL 1019)

### PARTI IN ALLUMINIO ALUMINIUM PARTS

Lucido, verniciato nero, bianco (RAL 9016) o tortora (RAL 1019) / Polished, black, white (RAL 9016), dove grey (RAL 1019) painted / Poli, verni couleur noir, blanc (RAL 9016) ou gris tourterelle (RAL 1019) / Pulido, acabado en negro, blanco (RAL 9016) o gris tórtola (RAL 1019)

### PARTI IN PLASTICA PLASTIC PARTS

Nero / Black / Noir / Negro

### PARTI IN LEGNO WOODEN PARTS

Faggio / Beechwood / Hêtre / Haya

### PARTI IN LAMINATO HPL LAMINATED HPL PARTS

Grigio (RAL 7039) o bianco (RAL 9003) / Grey (RAL 7039) or white (RAL 9003) painted / Gris (RAL 7039) ou blanc (RAL 9003) / Gris (RAL 7039) o blanco (RAL 9003)

## ACCESSORI ACCESSORIES

### BRACCIOLO ARMREST

Imbottito / Upholstered / Rembouré / Tapizado

### CUSCINI CUSHIONS

Amovibili / Removable / Amovibles / Extraibles

### TAVOLINO SIDE TABLE

Laminato HPL / Laminated HPL / Stratifié HPL / Laminado HPL

### GAMBA LEG

Alluminio / Aluminium / Aluminium / Aluminio  
Legno / Wood / Bois / Madera

### TERMINALI GLIDES

Materiale plastico / Plastic / En plastique / Patas de plástico

## RIVESTIMENTI COVERINGS



tessuto  
fabric  
tissu  
tela

AG - AR - AL - BR - BB - BL - CT - CE - DB - ET



pelle  
leather  
cuir  
cuero

EP - FP

ATTESE WAITING  
**ALIAS SOFT SEATING**

**MISURE E VARIANTI SIZES AND VARIANTS**

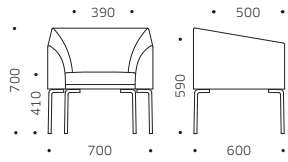

**AS1ML**

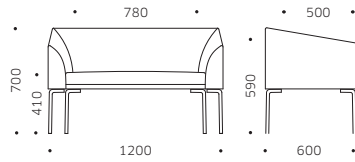

**AS2ML**

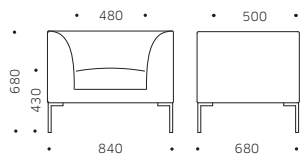

**AS10L / AS10W**

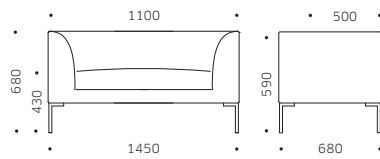

**AS20L / AS20W**

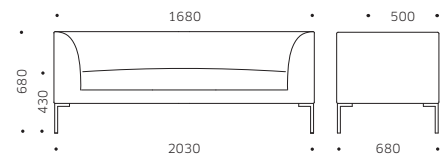

**AS30L**

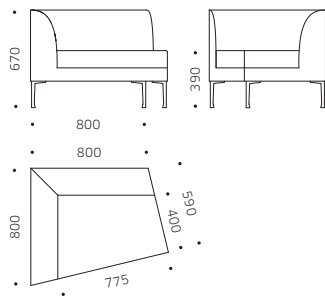

**AS1DL**

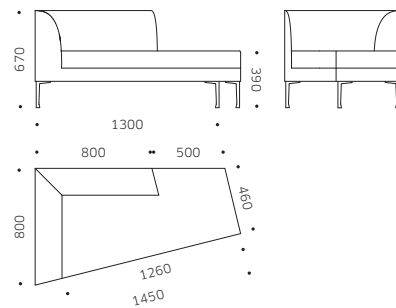

**AS2DL**

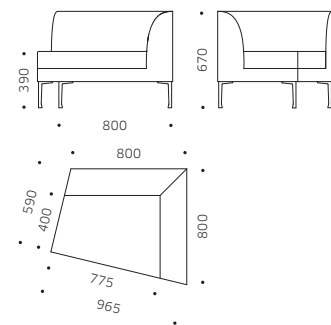

**AS1SB**

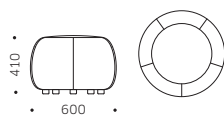

**PM06F**

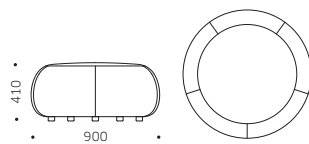

**PM09F**

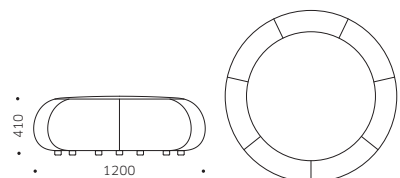

**PM12F**



## ESEMPI DI COMPOSIZIONE EXAMPLES OF COMPOSITION

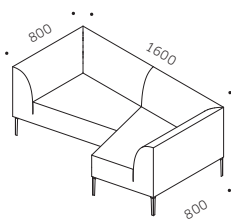

N.2 AS1DL

**modulo a 2 posti contigui**  
2 seater adjoining module  
module à 2 sièges joints  
módulo de 2 plazas  
contiguas

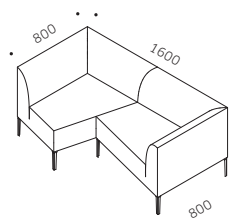

N.2 AS1SL

**modulo a 2 posti contigui**  
2 seater adjoining module  
module à 2 sièges joints  
módulo de 2 plazas  
contiguas

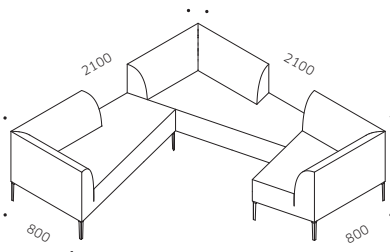

N.2 AS2DL + N.1 AS1DL

**angolare 3 posti contigui  
con allungo laterale**  
3 seater corner  
composition  
angolare a 3 sièges  
joints avec allonge latérale  
esquinero de 3 plazas  
contiguas, con  
prolongación lateral

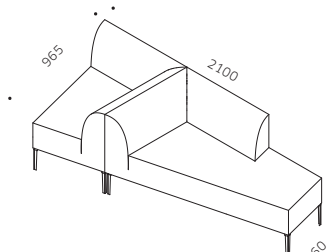

AS1DL+AS2DL

**modulo a 2 posti singoli,  
con allungo laterale**  
2 seater single module,  
with side extension  
module à 2 sièges isolés,  
avec allonge latérale  
módulo de 2 plazas  
individuales, con  
prolongación lateral

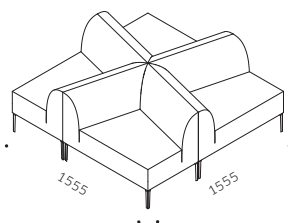

N.4 AS1DL

**isola a 4 posti singoli**  
4 single seater  
composition  
île à 4 sièges isolés  
isla de 4 plazas  
individuales

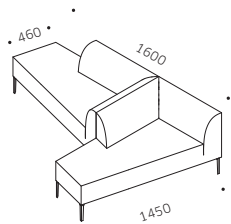

N.2 AS1SL

**modulo a 2 posti singoli,  
con allungo laterale**  
2 seater single module,  
with side extension  
module à 2 sièges isolés,  
avec allonge latérale  
módulo de 2 plazas  
individuales, con  
prolongación lateral

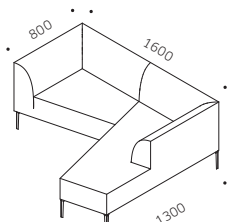

AS1DL+AS2DL

**modulo a 2 posti contigui,  
con allungo laterale**  
2 seater angular  
composition  
module à 2 sièges joints,  
avec allonge latérale  
módulo de 2 plazas  
contiguas, con  
prolongación lateral

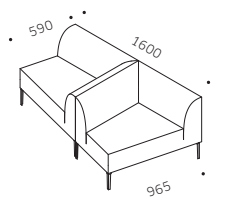

N.2 AS1SL

**modulo a 2 posti singoli**  
2 seater single module  
module à 2 sièges isolés  
módulo de 2 plazas  
individuales



VAGHI.COM

VAGHI s.r.l. via Brughetti 16/18 20813 Bovisio Masciago (MB)  
T +39 0362 591404 info@vagli.com

