

Hafa® Eden

Art: 1561010

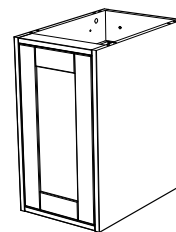

Spare Parts

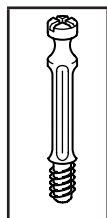

17

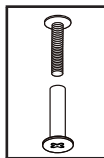

15

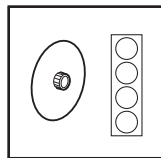

19

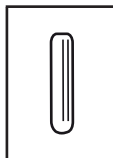

18



16

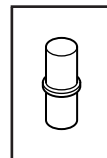

7

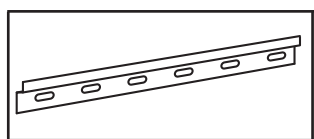

12

14

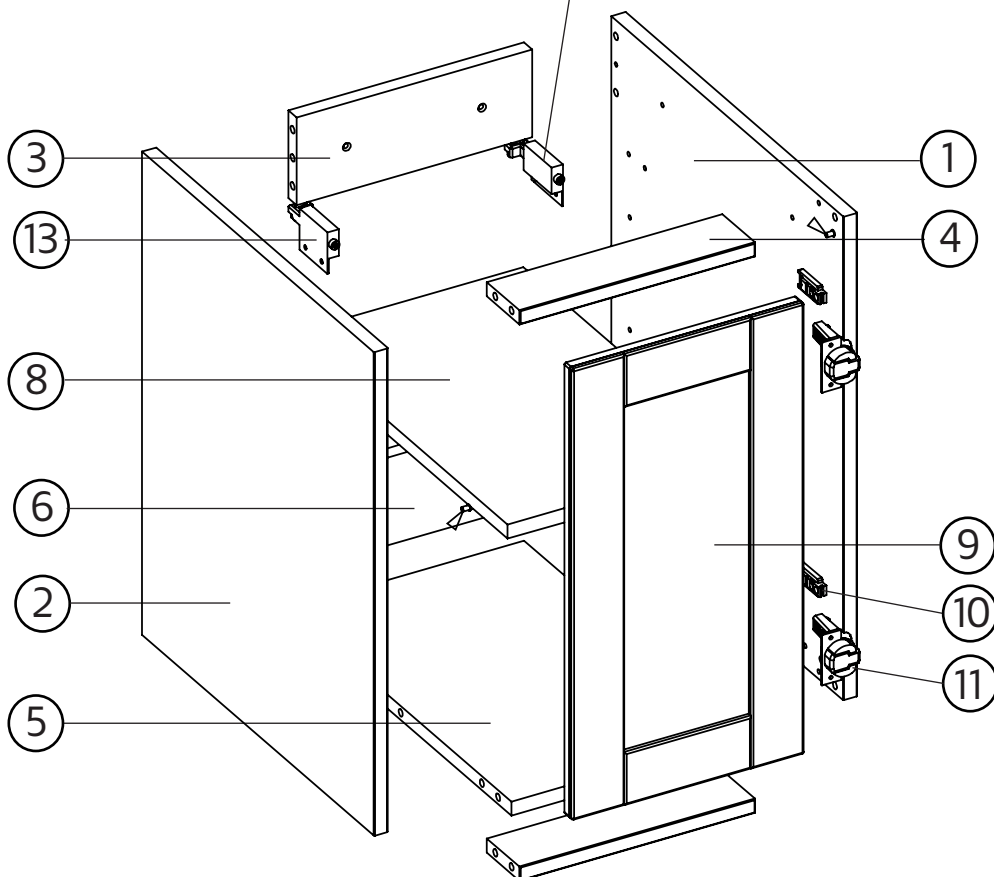

Hafa®

Hafa
Svarvaregatan 5, Box 525
SE-301 80 Halmstad
SWEDEN

Garanti/Warranty.
Service, resevdelar/spare-parts
Sweden: Tel: +46 (0)35 15 44 75
Norway: Tel: +47 69 31 02 30
Finland: Puh: 0207 43 50 00

www.hafa.se
www.hafa.dk
www.hafabad.no
www.hafa.se
www.hafabathroom.ru
www.hafa.eu

E-mail:
service@hafa.se
service@hafabad.no

SKETCH NO.	SPARE PART NO	Eden tvättställskåp 300	Eden wash basin cabinet 300
1	9204338	EDEN TVSK 300 HÖGER GAVEL VIT	EDEN WB-CA 300 RIGHT SIDE WHITE
2	9204339	EDEN TVSK 300 VÄNSTER GAVEL VIT	EDEN WB-CA 300 LEFT SIDE WHITE
3	9204340	EDEN TVSK 300 ÖVRE BAKRE REGEL VIT	EDEN WB-CA 300 UPPER BACK RAIL WHITE
4	9204341	EDEN TVSK 300 FRÅMRE REGEL VIT	EDEN WB-CA 300 FRONT RAIL WHITE
5	9204342	EDEN TVSK 300 BOTTEN VIT	EDEN WB-CA 300 BOTTOM WHITE
6	9204343	EDEN TVSK 300 NEDRE BAKRE REGEL VIT	EDEN WB-CA 300 LOWER BACK RAIL WHITE
7	9202006	EDEN TVSK 300 HYLLBÄRARE	EDEN WB-CA 300 SHELF SUPPORT
8	9204344	EDEN TVSK 300 HYLLA VIT	EDEN WB-CA 300 SHELF WHITE
9	9204345	EDEN TVSK 300 LUCKA VIT	EDEN WB-CA 300 DOOR WHITE
10	9204336	EDEN TVSK 300 STOMPLATTA BLUM	EDEN WB-CA 300 GUIDE BLUM
11	9204337	EDEN TVSK 300 GÅNGJÄRN BLUM MED DÄMPNING	EDEN WB-CA 300 HINGE BLUM SOFT CLOSE
12	9204397	EDEN TVSK 300 UPPHÄNGNINGSSKENA	EDEN WB-CA 300 ASSEMBLING RAIL
13	9202332	EDEN TVSK UPPHÄNGNINGSBESLAG VÄNSTER	EDEN WB-CA SUSPENSION LEFT
14	9202333	EDEN TVSK UPPHÄNGNINGSBESLAG HÖGER	EDEN WB-CA SUSPENSION RIGHT
15	9202024	EDEN TVSK SKRUV MED HYLSA	EDEN WB-CA SCREW WITH SLEEVE
16	9202031	EDEN SNÄCKLÅS	EDEN HOUSING
17	9202032	EDEN SNÄCKSKRUV	EDEN BOLT FOR HOUSING
18	9202033	EDEN TRÄPLUGG	EDEN DOWEL
19	9202025 9202027 9202029	EDEN TÄCKPLATTA MELAMIN VIT 14 MM EDEN TÄCKPLATTA MELAMIN VIT 20 MM EDEN TÄCKBRICKA VIT	EDEN MELAMIN COVER WHITE 14 MM EDEN MELAMIN COVER WHITE 20MM EDEN COVER CUP WHITE 14 MM