

USER MANUAL

BEDIENUNGSANLEITUNG
MODE D'EMPLOI
ISTRUZIONI PER L'USO

**KNOW
HOW
INSTALLED**

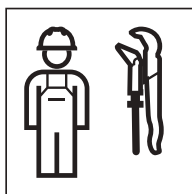



i

d16-63

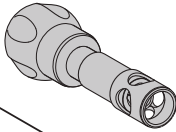

d16-63

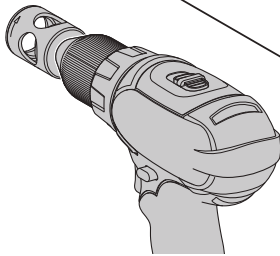

1

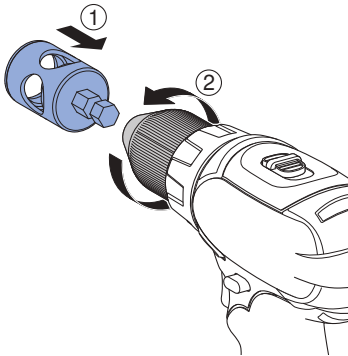

i

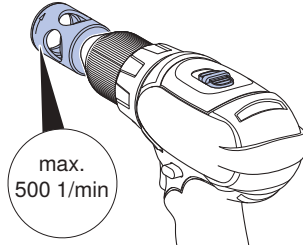

2

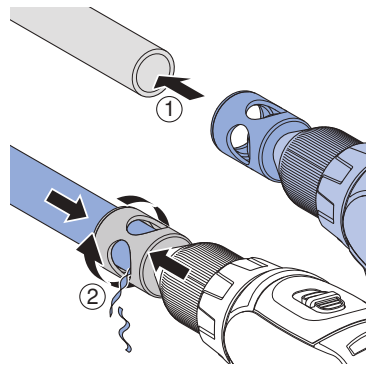

3

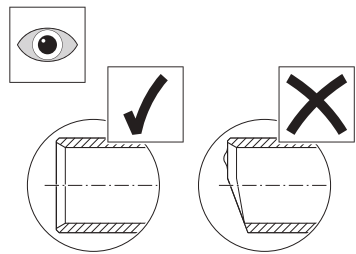

4

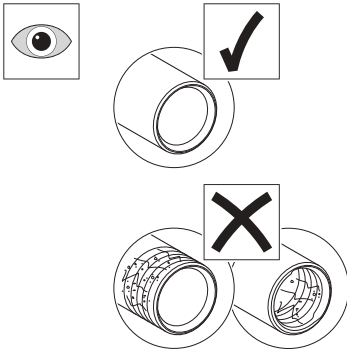

5

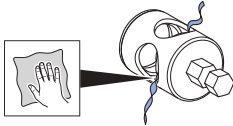



Geberit International AG
Schachenstrasse 77, CH-8645 Jona
documentation@geberit.com
www.geberit.com