

E-8373

VIGNOLA Series

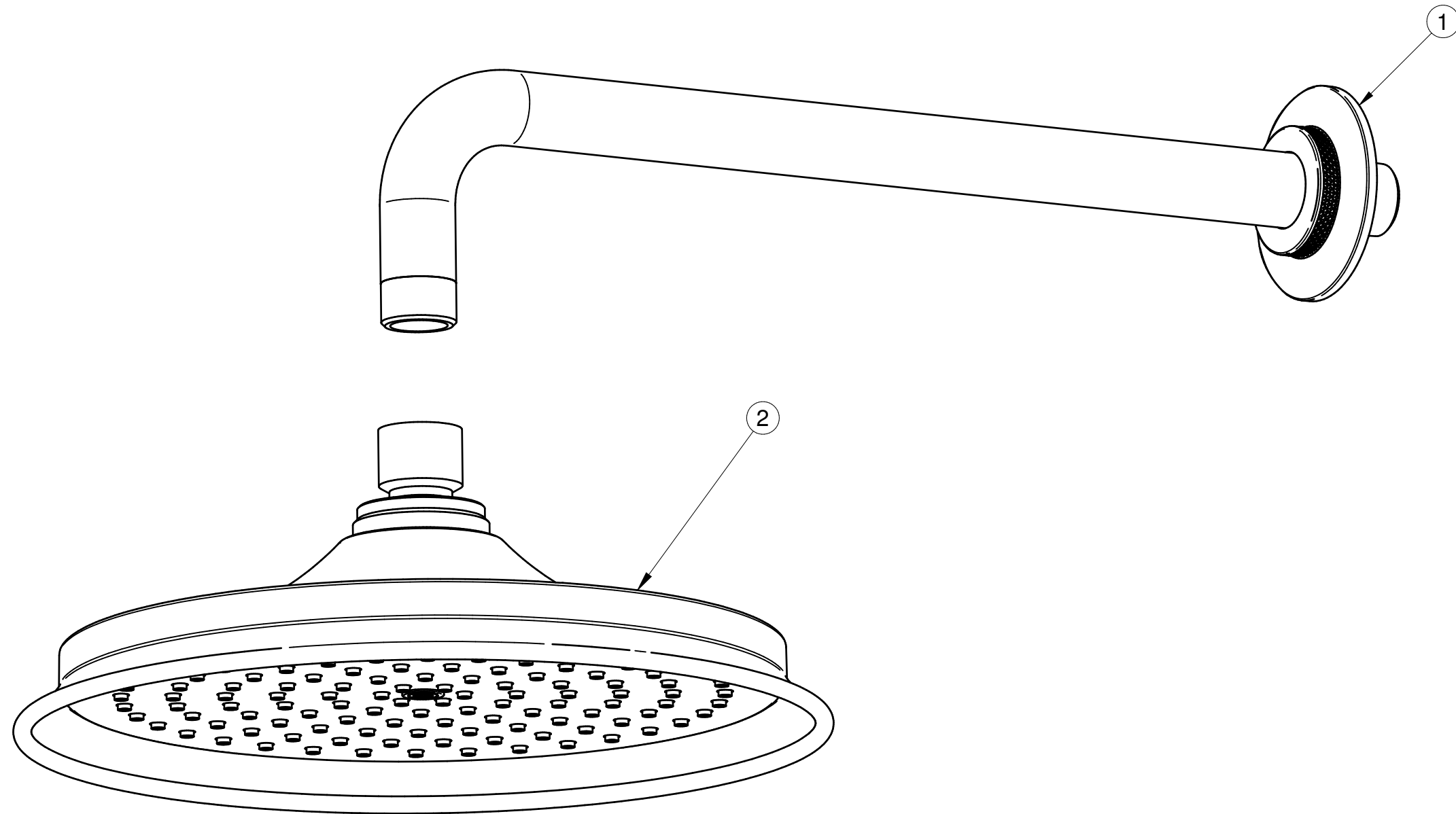

GRAFF®