



Underscore® Rectangle

66" x 36" Heated BubbleMassage™ air bath w/ whirlpool
K-1173-XHGH

Features

- 122 airjets release thousands of heated bubbles that surround, support, and massage the body.
- Variable-speed blower lets you adjust massage intensity to 18 levels.
- Eight Flexjet® hydromassage jets can be individually adjusted for water flow and direction.
- Variable-speed pump for adjusting hydromassage intensity.
- Built-in heater.
- Automatic and manual purge cycles remove residual water from air channels after use.
- 60-minute automatic shutoff timer.
- Slotted overflow allows for deep soaking.
- Generous 66" length provides spacious bathing for up to two people.
- Integral lumbar support.
- Keypad control.
- Textured bottom surface.

Material

- Acrylic.

Technology

- Heated BubbleMassage™ technology warms and humidifies air before it enters the bath.

Installation

- Drop-in or undermount.
- Reversible drain.
- 120V electrical requirement allows for easy installation with standard outlet.
- Requires three dedicated circuits.

Required Products/Accessories

K-7271 Brass Slotted Overflow Bath Drain
K-9698 Flexjet® Whirlpool Trim Kit

or

K-7272 PVC Slotted Overflow Bath Drain
K-9698 Flexjet® Whirlpool Trim Kit

Recommended Products/Accessories

K-1491 Bath/Whirlpool Pillow
K-1601 Bath/Whirlpool Footstop
K-1703 Whirlpool Remote Control
K-9497 2-1/2" Keypad Trim
K-24916 Wireless Music Kit
K-702200-G54 Frameless Sliding Bath Door
K-702200-G73 Frameless Sliding Bath Door
K-702200-L Frameless Sliding Bath Door
K-702205-L Frameless Sliding Bath Door
K-706000-D3 Frameless Sliding Bath Door



Codes/Standards







ASME A112.19.7/CSA B45.10
CSA B45.5/IAPMO Z124
ASTM E162
ASTM E662
UL 1795
CSA C22.2 No. 218.2

KOHLER® Hydrotherapy Components
Five-Year Limited Warranty
KOHLER® Plastic Baths and Receptors
Lifetime Limited Warranty

See website for detailed warranty information.

Available Colors/Finishes

Color tiles intended for reference only.

Color	Code	Description
	0	White
	96	Biscuit
	NY	Dune
	95	Ice™ Grey
	58	Thunder™ Grey
	7	Black Black™

1-800-4KOHLER (1-800-456-4537)

Kohler Co. reserves the right to make revisions without notice to product specifications.

For the most current Specification Sheet, go to www.kohler.com.

1-25-2020 05:40 - US/CA

THE BOLD LOOK
OF **KOHLER**®



Underscore® Rectangle

66" x 36" Heated BubbleMassage™ air bath w/ whirlpool

K-1173-XHGH

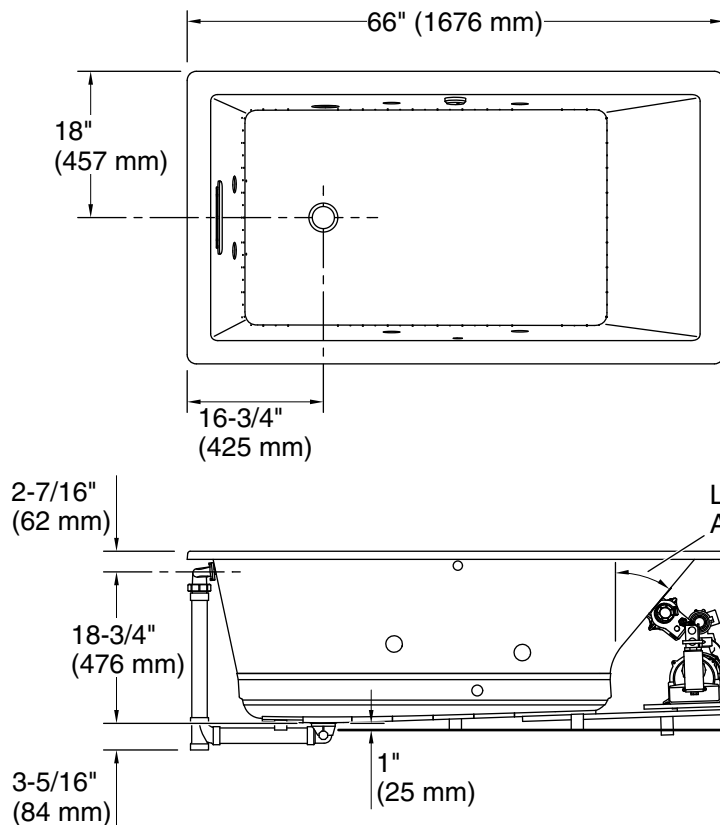

No change in measurements if connected with drain illustrated. (K-7272)

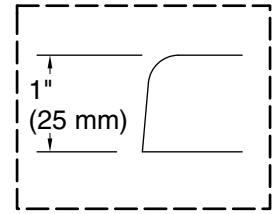

Drop-in Rim Detail

Blower Motor Access
30" (762 mm) W x 15" (381 mm) H Min

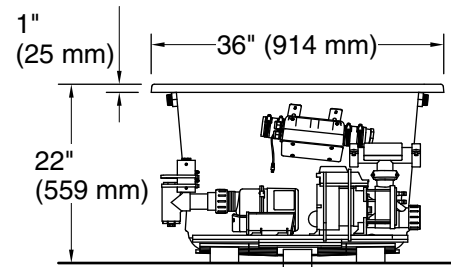

1-1/2" Bath Drain

Required Electrical Service

Three dedicated circuits required, protected with Class A Ground-Fault Circuit-Interrupter (GFCI). Outside North America, this device may be known as a Residual Current Device (RCD).

Blower:	120 V, 15 A, 60 Hz
Air bath, Pump:	120 V, 15 A, 60 Hz
Heater:	120 V, 15 A, 60 Hz

Technical Information

All product dimensions are nominal.

Installation:	Drop-in, Undermount
Drain location:	End
Basin area, bottom:	44-1/2" x 26-1/2" (1130 mm x 673 mm)
Basin area, top:	60-1/4" x 30-1/4" (1530 mm x 768 mm)
Weight:	182 lbs (82.6 kg)
Minimum floor load:	62.5 lbs/ft ² (305.2 kg/m ²)
Water depth:	17-3/4" (450 mm)
Water capacity:	102 gal (386.1 L)
Cutout:	Drop-in, 65-1/2" x 35-1/2" (1664 mm x 902 mm)
Electrical component rating:	Blower: 120 V, 10 A, 60 Hz Air bath: 120 V, 5 A, 60 Hz

Notes

Measure your actual product for rough-in details. Install this product according to the installation instructions.

The hot water supply should be 70% of the capacity of the bath or greater. Installations will vary.