

A solid and
reliable foundation

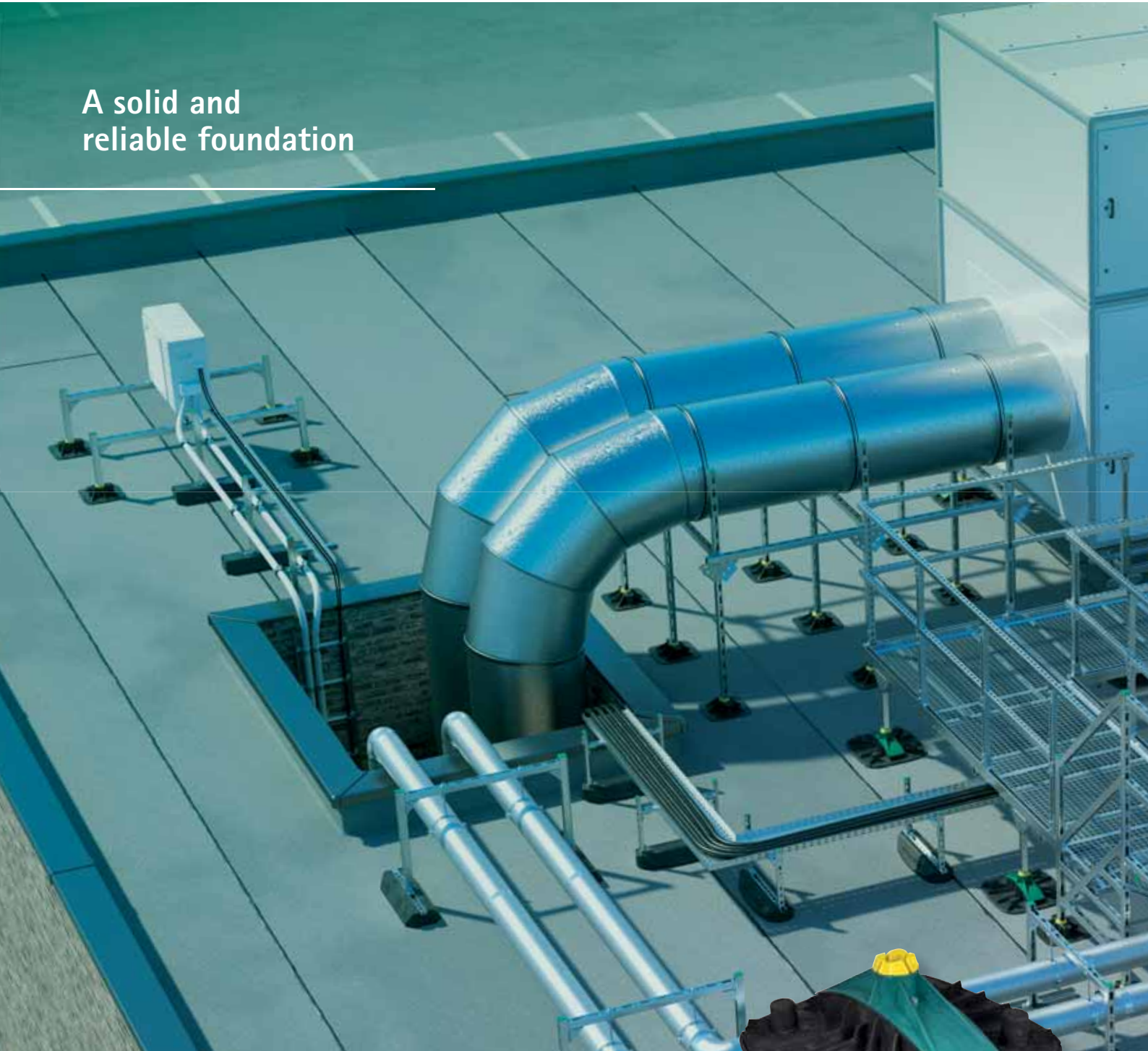

BIS Yeti[®]

For any Strut based installation



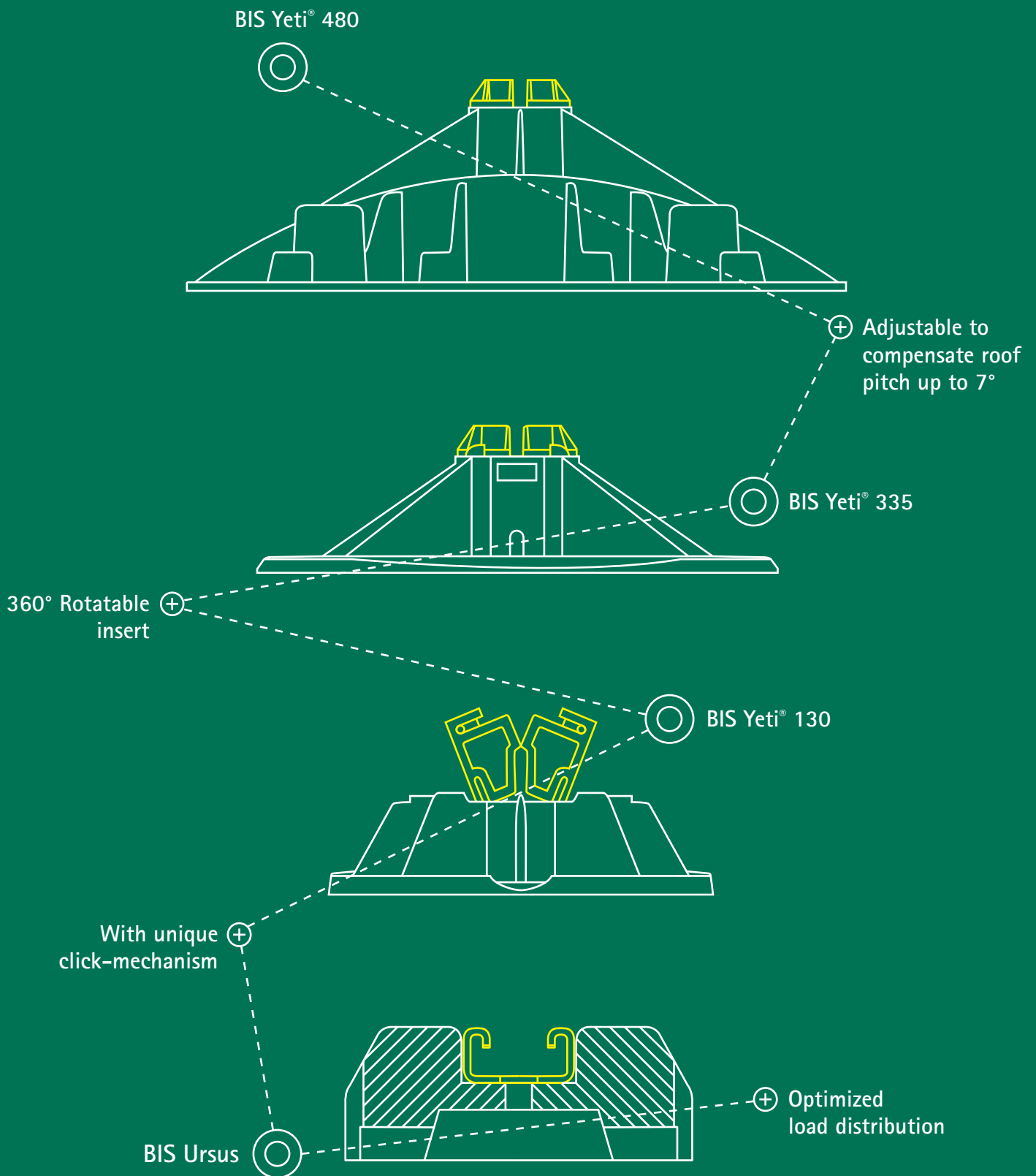

Inspired by smart solutions from the start

Walraven is a globally active company in the installation industry, founded in 1942. We have always been dedicated to make the work of our customers easier and more effective. With simple and smart solutions, comprehensive services and excellent support.

Walraven. The value of smart

Walraven Roof Support System

A solid and reliable foundation for any Strut based installation

BIS Yeti® 480



BIS Yeti® 480 is a non-penetrative, modular system for supporting installations on flat roofs, other flat surfaces and even on low pitched roofs (up to 7°). The sturdy BIS Yeti® feet are used in combination with BIS RapidStrut® fixing rail. With the optional ballast blocks extra weight can be added providing even greater stability. The BIS Yeti® 480, available for both vertical and horizontal applications, is equipped with a non-slip, anti-vibration mat which prevents damage to the roof membrane, thereby minimising the risk of leakage.

BIS Yeti® 335



The BIS Yeti® 335 is the smaller family member of the BIS Yeti® 480. It is designed to support installations on flat roofs or other flat surfaces, in combination with BIS RapidStrut® fixing rail.

The BIS Yeti® 335, available for both vertical and horizontal applications, is supplied with a 360° rotatable insert, allowing precise positioning. It also comes with a non-slip, anti-vibration mat to prevent damage to the roof membrane.

BIS Yeti® 130



A flexible and reliable foundation for light Strut based installations on roofs. It also comes with a non-slip, anti-vibration mat to prevent damage to the roof membrane.

BIS Ursus Foot



BIS Ursus is designed to support small, linear pipework systems, ductwork runs, cable trays and is ideal for climate installations, walkways and similar on flat roofs. The BIS Ursus Foot Support System is made from UV resistant, vulcanised rubber, and includes a BIS RapidStrut® fixing rail piece, with BIS UltraProtect® 1000 surface treatment.

Features and benefits



No drilling required

Prevents penetration of roof membrane and reduces the risk of leaks.



Recyclable

Mounting units are made from recycled weather and UV resistant materials.



Optimized load distribution

Optimal distribution of the load and reduction of dead weight protects the roof surface.



Saves time and money

Easy to use modular support system.



Sound & vibration proof

With non-slip anti-vibration mat.



SG Bauakustik

Nr. 1762-001-18



*For flat and low pitched
roofs and high loads*

BIS Yeti® 480

Adjustable for precise positioning and suitable for high loads

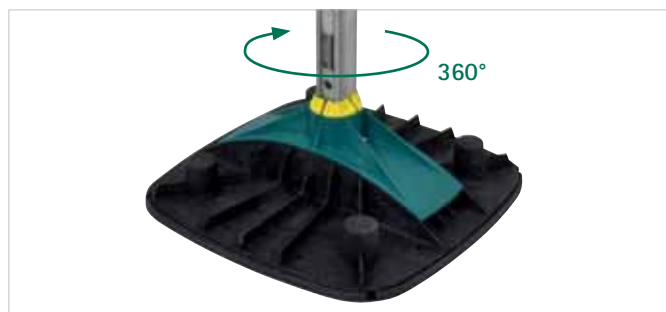

- 360° rotatable insert



- Adjustable to compensate roof pitch up to 7°



- With non-slip anti-vibration mat



- Optional stackable ballast block to increase stability

Technical data

BIS Yeti® 480

Part No.	Model	Size
67685001	Vertical	480 x 480 mm
67685101	Horizontal	480 x 480 mm

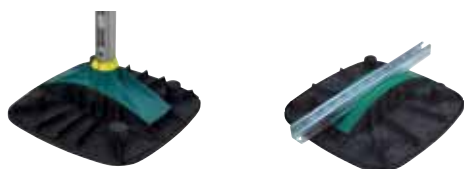

Ballast Block

Part No.	Weight	In combination
67685401	8 kg	Yeti® 480



Mouldings made from WPC, a composite of recycled plastic and wood fibre.
Resistant to UV and chemical influences.

Maximum allowed loads*

The maximum allowed load is tested on a flat concrete surface under straight load. For technical support or advice on these products applied to anything other than concrete floors please contact our project engineers.

* In combination with BIS RapidStrut® Rail.

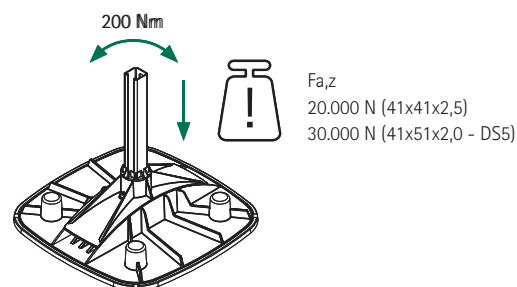

📞 Tel. +44 (0)1295 75 34 00
🌐 walraven.com

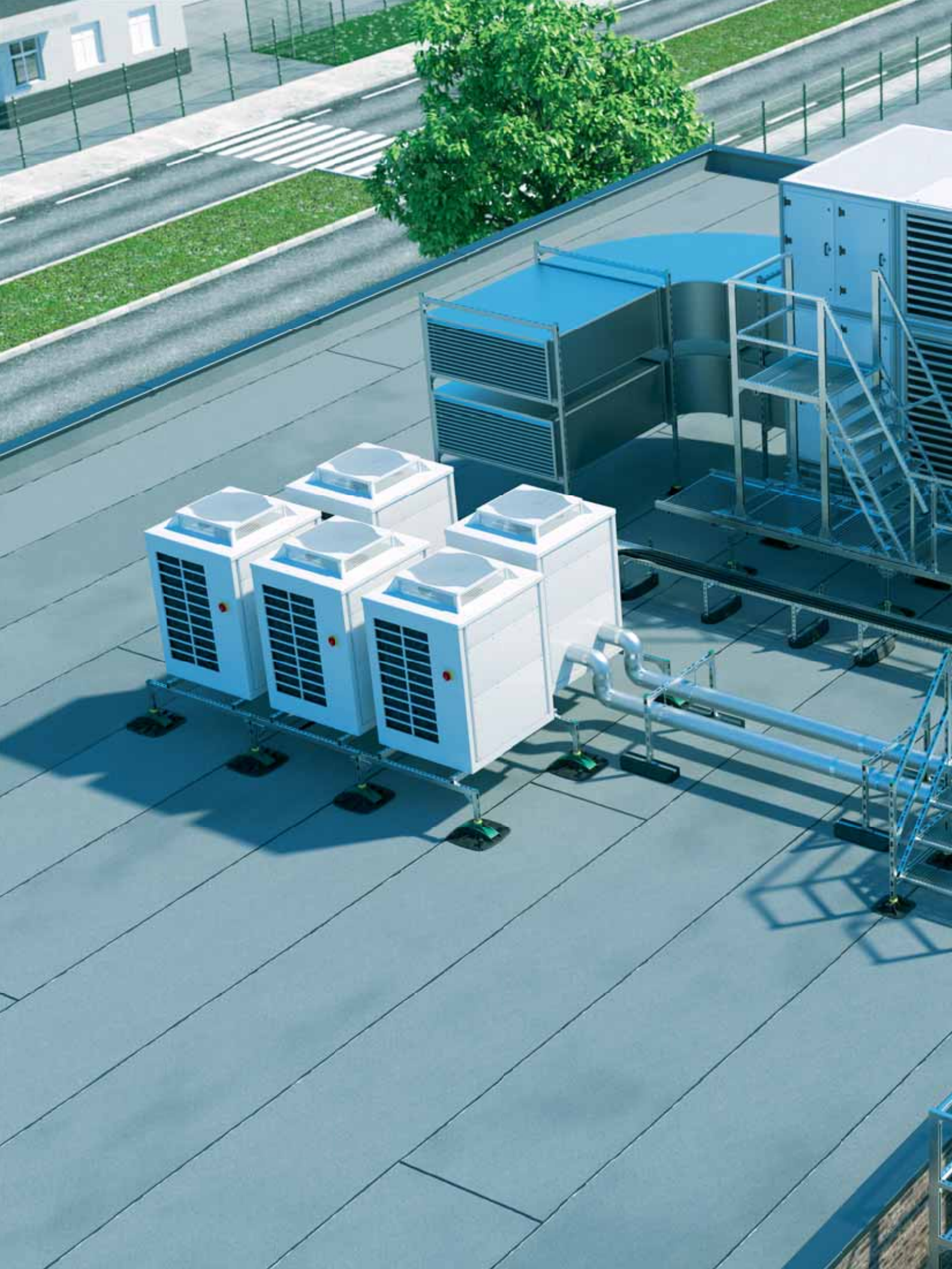

The value of smart

Flexible application options with BIS RapidStrut® System

- Combines with all BIS Yeti® & BIS Ursus products
- Extensive range of rails and accessories
- Fast and easy fixing
- Very high corrosion resistance





*For flat roofs, for
horizontal and vertical
applications*

BIS Yeti® 335

Adjustable for precise positioning

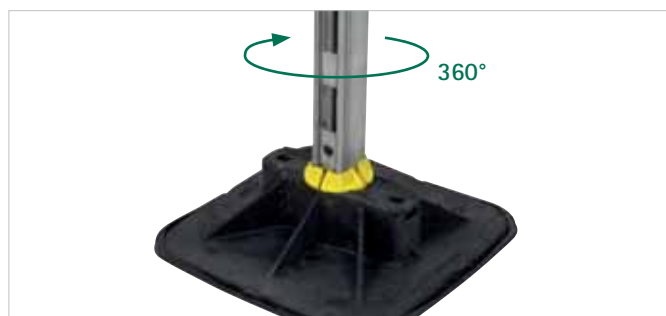

- 360° rotatable insert

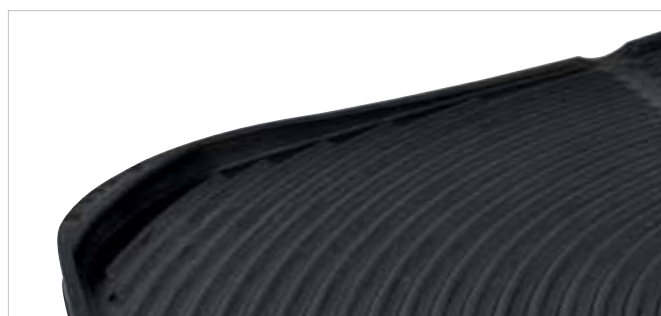

- With non-slip anti-vibration mat

Frame Set

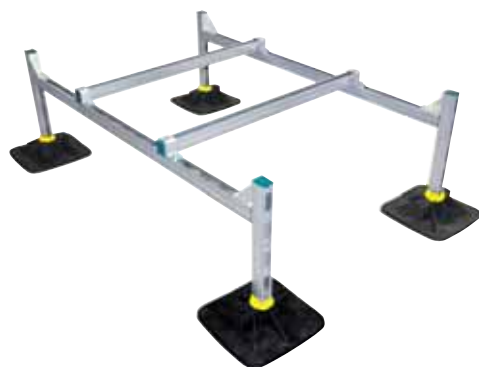

- Also available as a complete Frame-Set.
67685501

H-Set

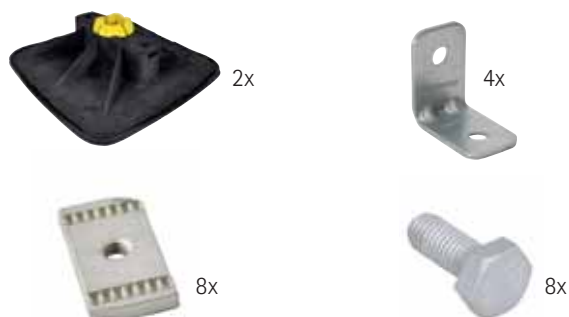

- Also available as H-Set (rails are not included).
67685302

Technical data

BIS Yeti® 335

Part No.	Model	Size
67685201	For horizontal and vertical use	335 x 335 mm

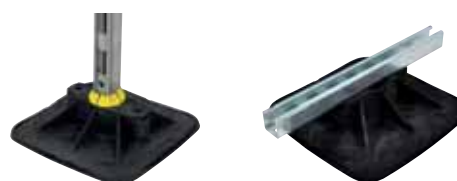

Mouldings made from WPC, a composite of recycled plastic and wood fibre. Resistant to UV and chemical influences.

Maximum allowed loads*

The maximum allowed load is tested on a flat concrete surface under straight load. For technical support or advice on these products applied to anything other than concrete floors please contact our project engineers.

* In combination with BIS RapidStrut® Rail.

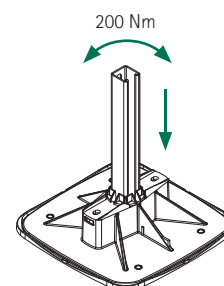
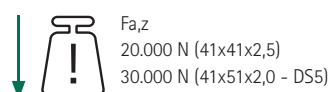

? Tel. +44 (0)1295 75 34 00
i walraven.com



*A flexible and reliable
foundation for light Strut based
installations on roofs*

BIS Yeti® 130

With unique click-mechanism

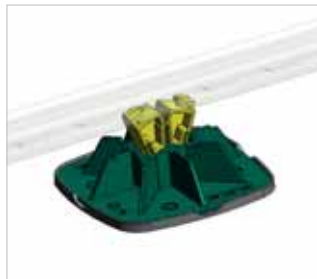

The insert is automatically closing when the rail gets pushed in

Features and benefits

- Suitable for light applications
- With unique click-mechanism
- With sound absorbing and non-slip anti-vibration mat
- Flexibility to use - build your solution
- Cost-effective but still high quality

Technical data

- Mouldings made from WPC, a composite of recycled plastic and wood fibre
- Made from 100% recycled plastic
- Resistant to UV and chemical influences
- 130 x 130 mm
- For horizontal and vertical use
- # 67685130
- Maximum load is 2500 N

Horizontal use

All Strut rails with standard hole pattern can be used, preferably 41 x 21 x 2,5 or 41 x 41x 2,5. You can build your own length of horizontal support.

Vertical use

Strut rails 41 x 21 can be used as H-construction for light weights, the adapter is not necessary, just push the rail into the body of BIS Yeti® 130.

Applications



■ Duct Support



■ Pipe Support



■ Cable Tray Support



■ Step-overs / Walkways

📞 Tel. +44 (0)1295 75 34 00
 ⓘ walraven.com

BIS UltraProtect® 1000

Optimal protection

- All applied surface treatments effortlessly withstand a salt spray test of at least 1000 hours*
- Suitable for corrosive environments (C1–C4 in accordance with ISO 12944-2)



Better than Hot Dip Galvanizing

- Higher corrosion resistance: 1000 hours* versus 300 - 600 hours (with a layer thickness of 50 - 80 µm)
- Threaded products are also well protected
- Products feel smooth and are also visually appealing



Complementary system

- The products in the BIS UltraProtect® 1000 System combine together perfectly
- Can also be combined with zinc plated, pre-galvanized or hot dip galvanized products



*Until the occurrence of maximum 5% red rust.

The proof after 1000 hours salt spray test

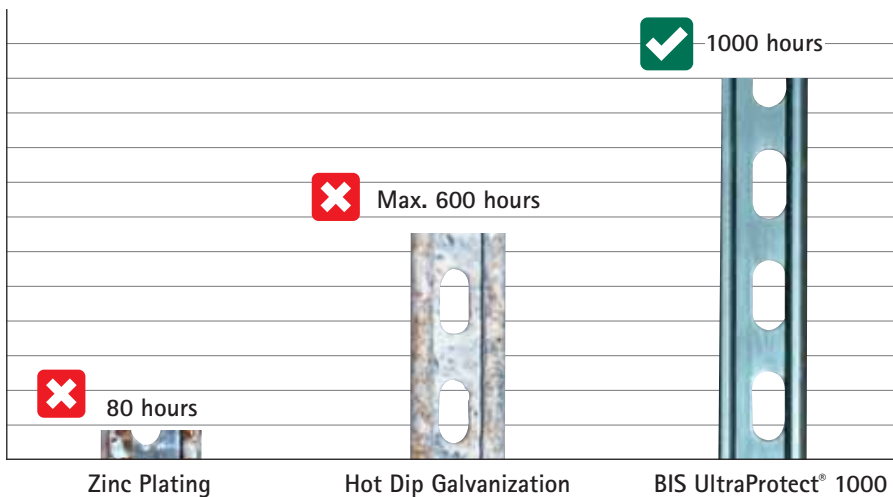

Corrosion resistance

- C1 - C4 / ISO 12944-2

Salt spray test

- 1000 hour / ISO 9227

Complementary system

- Perfect combination with other products



*For supporting small
pipework systems, ductwork
runs and cable trays*

BIS Ursus Foot

For linear installation systems

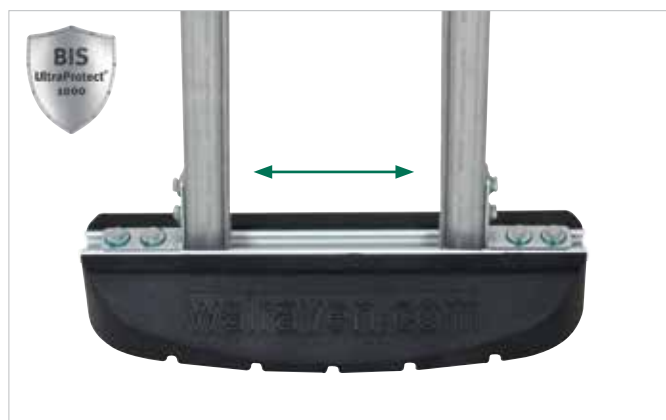

- For linear installation with BIS RapidStrut® System

Technical data

- Material: vulcanized rubber, black
- Resistant to UV and chemical influences

1. BIS Ursus 250 x 130 mm - # 67687250
2. BIS Ursus 400 x 130 mm - # 67687400
3. BIS Ursus 600 x 200 mm - # 67687601



Maximum allowed loads*

The maximum allowed load is tested on a flat concrete surface under straight load. For technical support or advice on these products applied to anything other than concrete floors please contact our project engineers.

*In combination with BIS RapidStrut® Rail.

BIS Yeti® 335 Hinge

For Rooftop Installations

Features and benefits

- Adjustable connector for rails
- Fully flexible in angle and direction due to rotatable insert in Yeti 335
- Material: steel 1.0332
- Suitable for in- and outdoor application

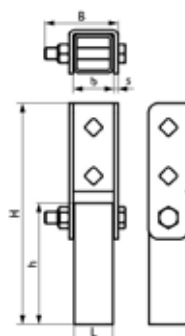

Technical data

Part No.	L	B (mm)	H (mm)	h (mm)	b (mm)	s (mm)
67685414	40	70	228	125	42	4

☎ Tel. +44 (0)1295 75 34 00

🌐 walraven.com

Find out how we can support you

Would you like to find out more about any of the solutions described in this brochure?
Or would you like to discuss how we could help you find the best possible solution for your project? Get in touch today!

United Kingdom Ireland

Walraven Ltd.

Thorpe Way, Banbury (GB)
Oxon, OX16 4UU
Tel. +44 (0)1295 75 34 00
Fax +44 (0)1295 75 34 28
sales.uk@walraven.com

Walraven Group

Mijdrecht (NL) · Tienen (BE) · Bayreuth (DE) · Banbury (GB) · Malmö (SE) · Grenoble (FR) · Barcelona (ES) · Kraków (PL)
Mladá Boleslav (CZ) · Moscow (RU) · Kyiv (UA) · Detroit (US) · Shanghai (CN) · Dubai (AE) · Budapest (HU) · Mumbai (IN)
Singapore (SG)

