

Art.: 3196N

Válvula de escuadra con filtro - rosca NPT / Angle valve with filter - NPT thread

Características	Features
1. Válvula de escuadra con filtro, paso estándar.	1. Angle ball valve with filter, standard bore.
2. Construcción en latón forjado s/ UNE-EN 12165.	2. Made in hot forging brass according UNE-EN 12165.
3. Extremo roscado hembra NPT s/ ANSI B 1.2.0.1 y macho s/ ISO 228/1.	3. Threaded NPT female end acc/ ANSI 1.2.0.1 and male acc/ ISO 228/1.
4. Asientos en NBR.	4. NBR Seats.
5. Maneta en ABS.	5. Handle made in ABS
6. Presión máxima de trabajo 10 bar (PN 10).	6. Maximum working pressure 10 bar (PN 10).
7. Temperatura de trabajo desde -20°C a 110°C.	7. Working temperature from -20°C to 110°C
8. Filtro construido en acero inoxidable AISI 316.	8. Filter made by stainless steel AISI 316.
9. Acabado cromado brillante.	9. Finishing chrome plated.

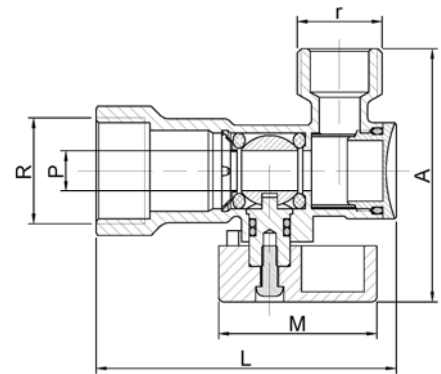
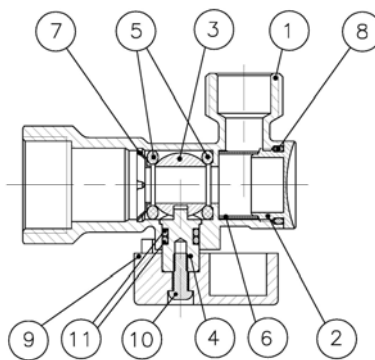

Nº	Denominación/Name	Material	Acabado Superficial/Surface Treatment
1	Cuerpo / Body	Latón / Brass (CW617N)	Cromado / Chrome plated
2	Tapa / Cap	Latón / Brass (CW617N)	Cromado / Chrome plated
3	Esfera / Ball	Latón / Brass (CW617N)	Cromado / Chrome plated
4	Eje / Stem	Latón / Brass (CW617N)	-
5	Asientos / Seats	NBR	-
6	Filtro / Filter	Acero Inox. / S. Steel (AISI 316)	-
7	Tapa asiento / Seat cap	Acero Inox. / S. Steel (AISI 316)	-
8	Tórica / O-ring	NBR	-
9	Maneta / Handle	ABS	Cromado / Chrome plated
10	Tornillo / Screw	Acero / Steel	Cromado / Chrome plated
11	Tórica / O-ring	NBR	-

Ref. / Ref.	Medida / Size	Dimensiones / Dimensions (mm)						Peso / Weight (Kg)
		P	R	r	L	A	M	
3196N 04 04	1/2" NPT x G 1/2"	8	1/2" NPT	G 1/2"	59	50	31	0,104