

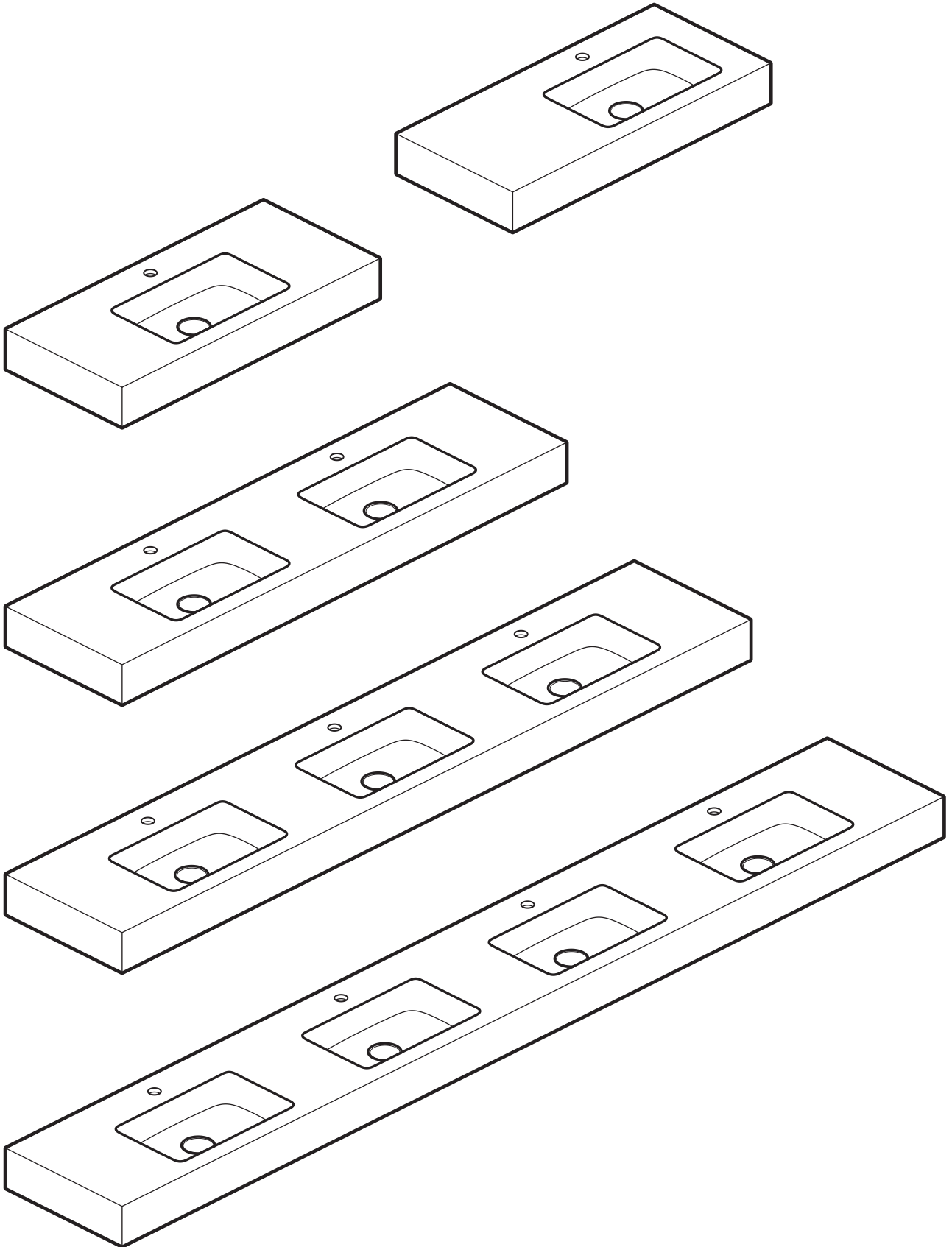







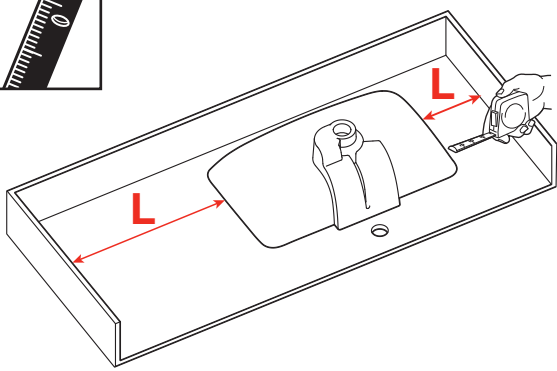
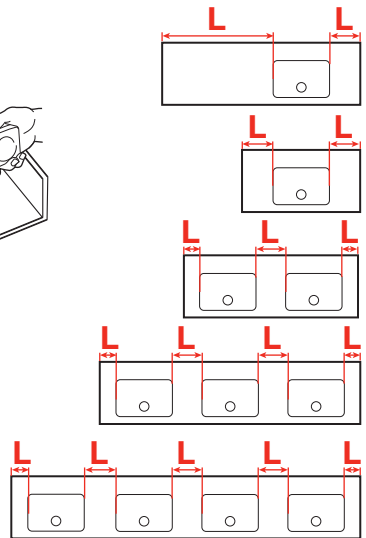

Roca

MODO



L		
55 - 450	 x1	→ A
451 - 900	 x2	→ B
901 - 1350	 x3	→ C
1351 - 1800	 x4	→ D
1801 - 2315	 x5	→ E

[mm]

A L = 55 - 450

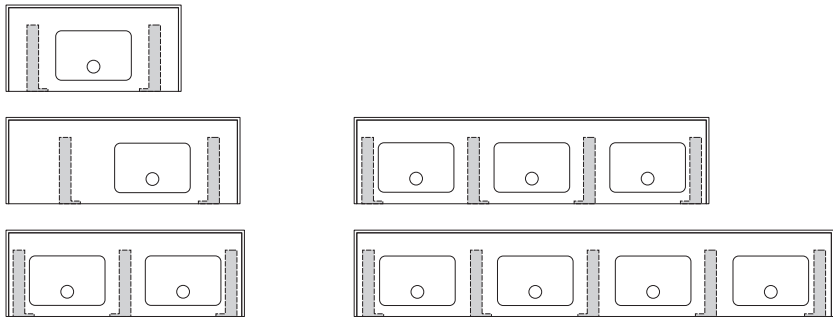

1

(÷2) (÷2)

2

3

A **B**



A **B** **C** **D** **E**

4

A **D**

B **E**

C

 →  **5**

B L = 451 - 900

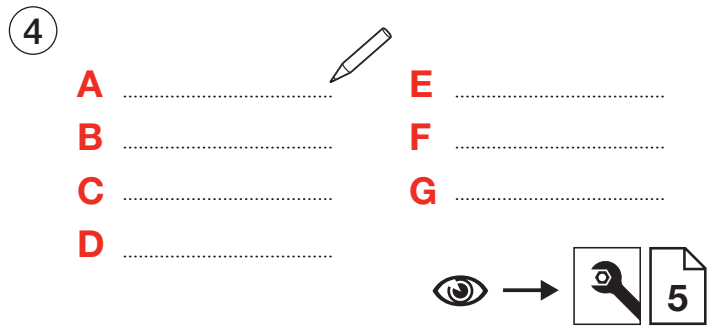
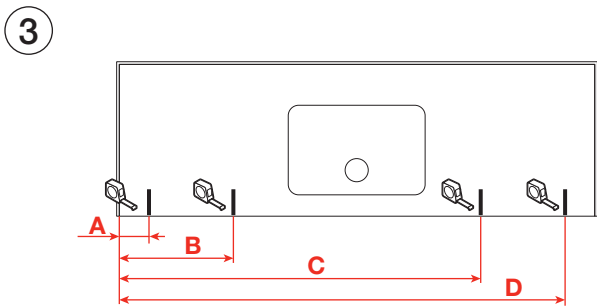
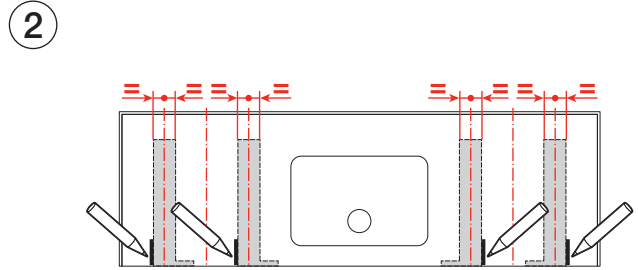
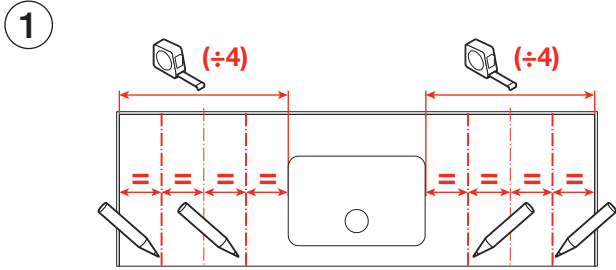
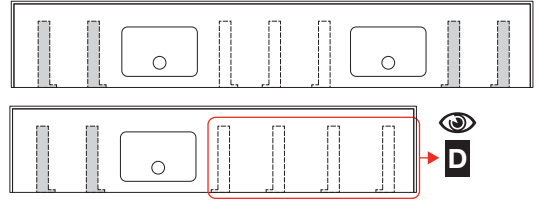
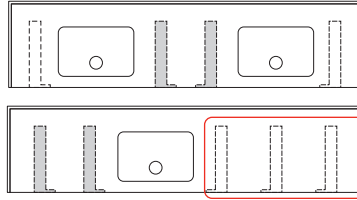
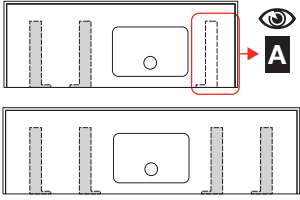

C L = 901 - 1350

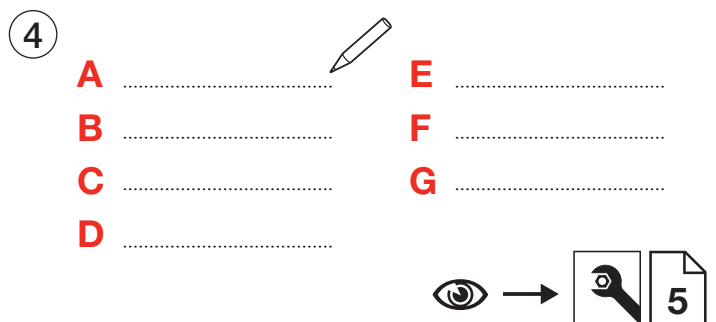
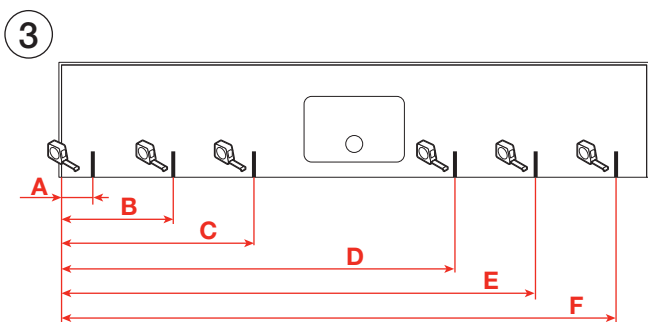
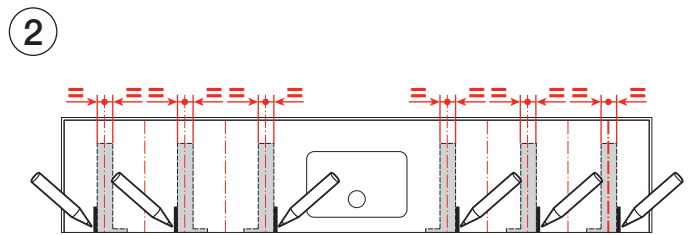
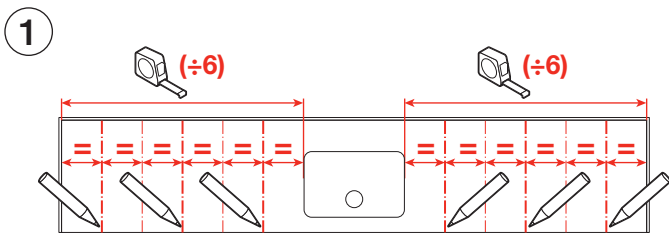
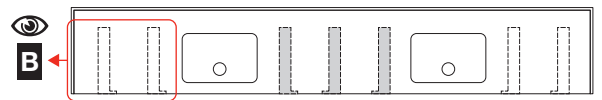
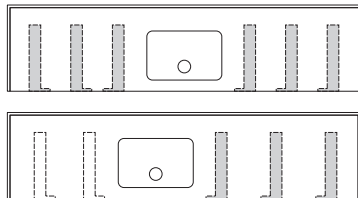
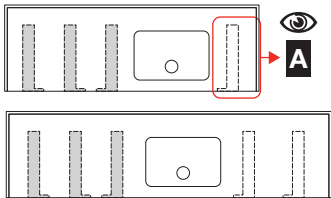

D L = 1351 - 1800

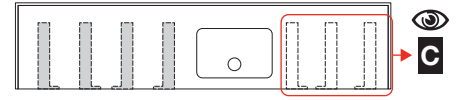
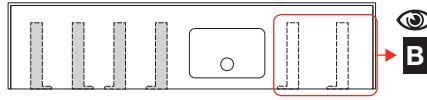
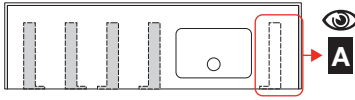

1

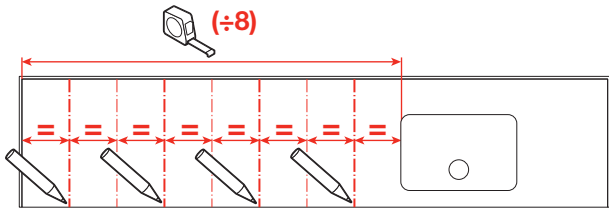

2

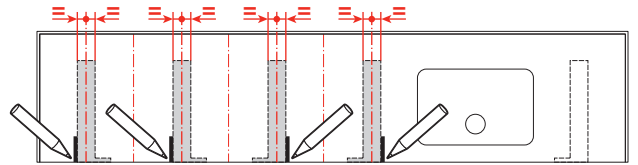

3

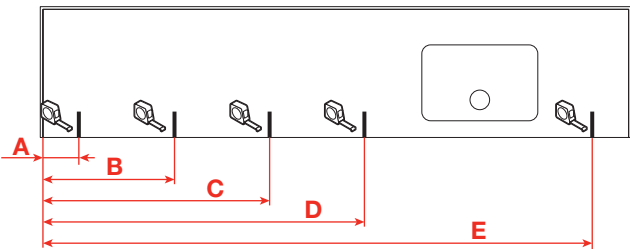

4

A  E

B F

C G

D

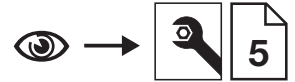

E L = 1801 - 2315

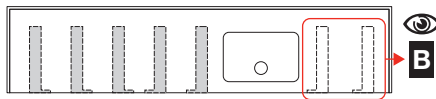
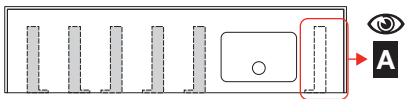

1

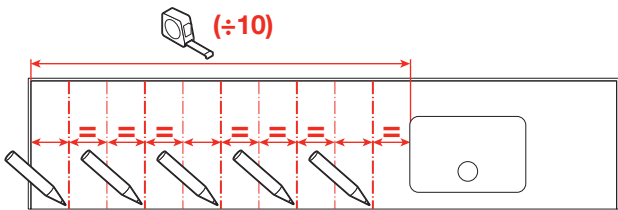

2

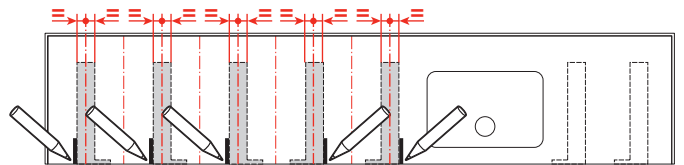

3

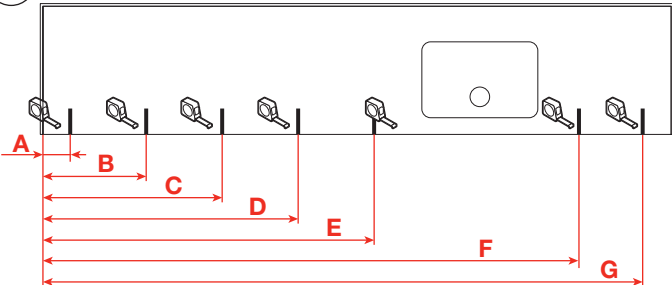

4

A  E

B F

C G

D





1

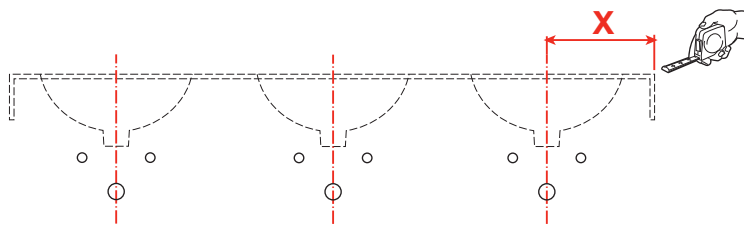
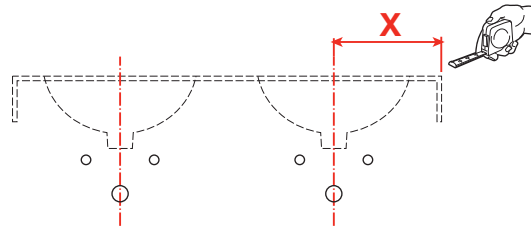
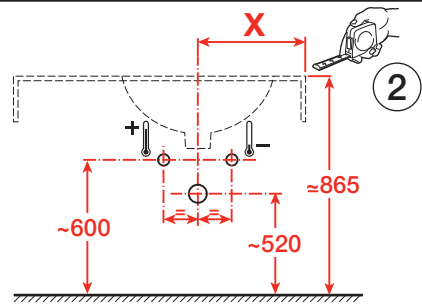
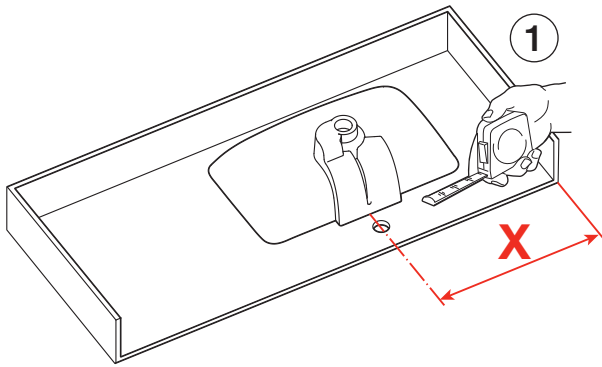

2

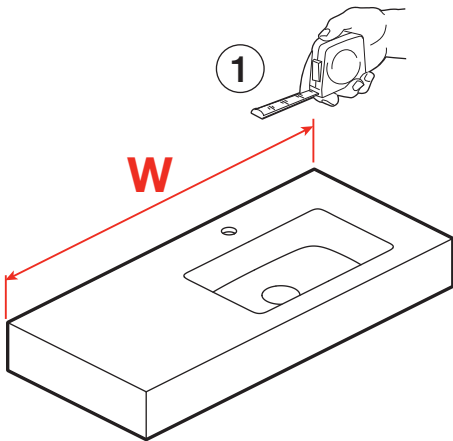

1

2

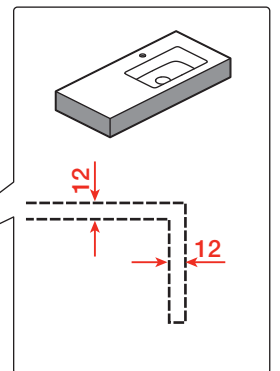
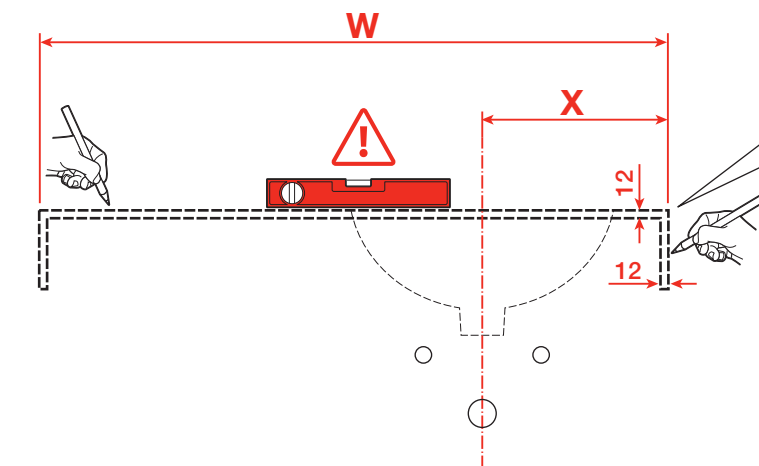

3

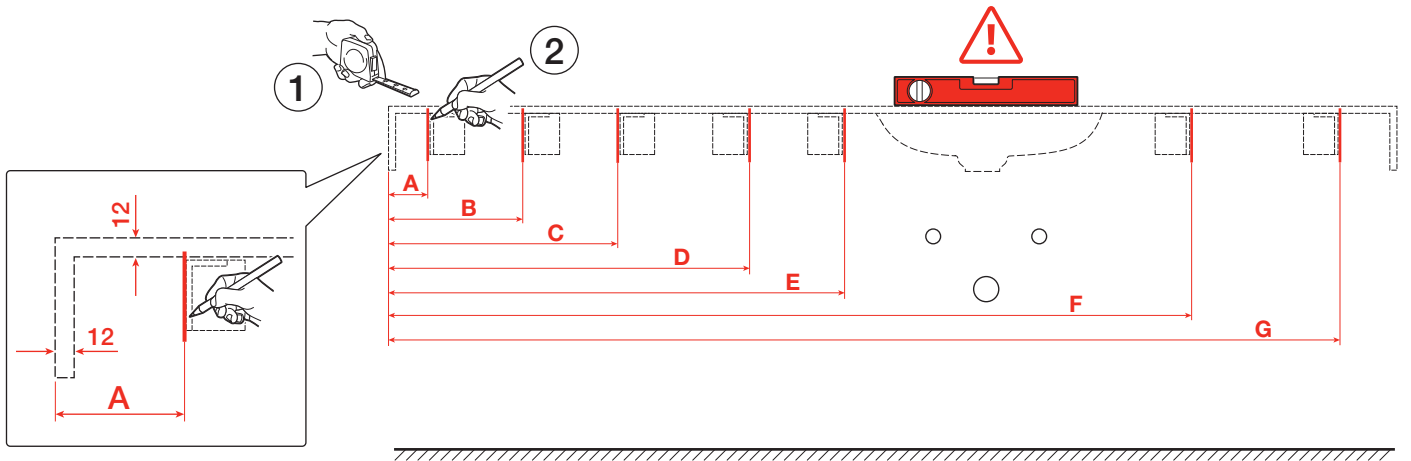

4

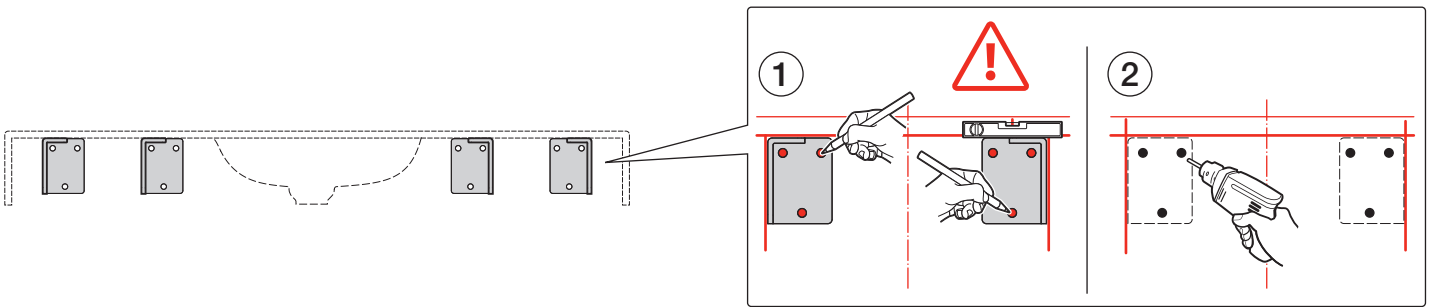

5

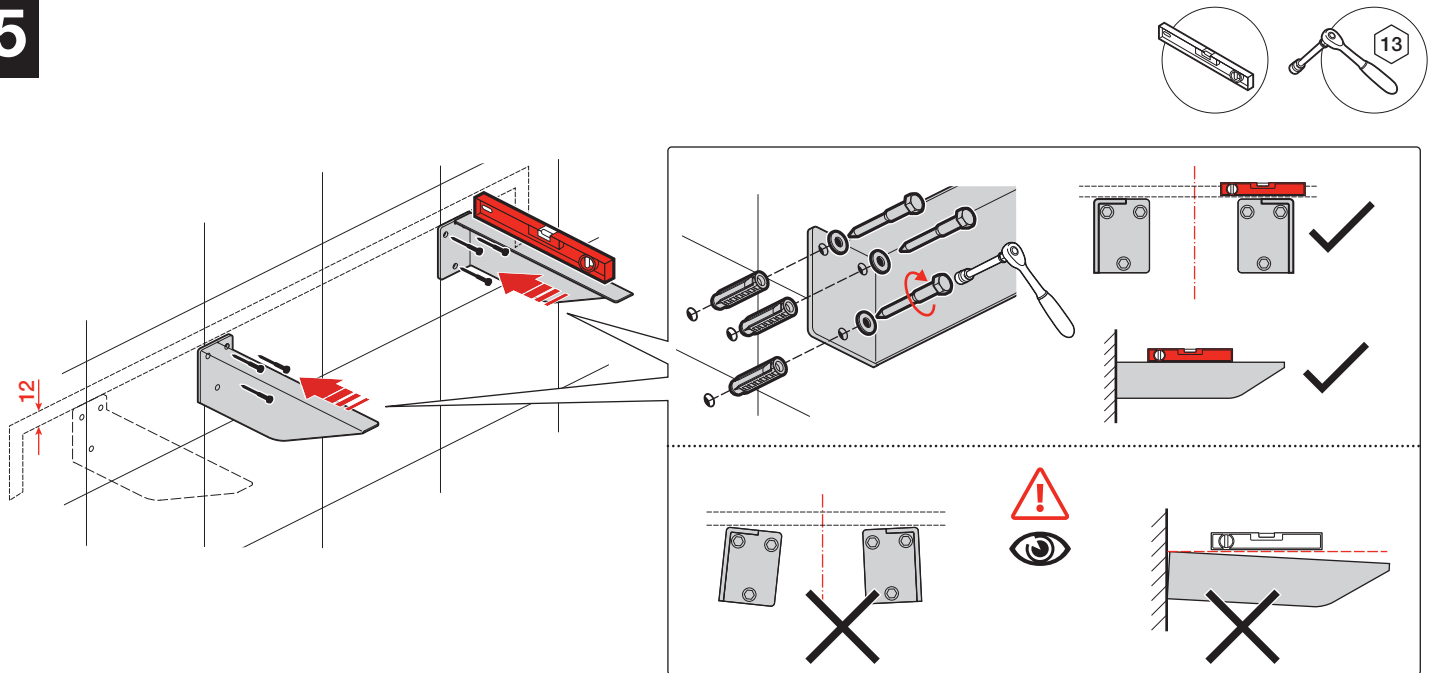

6

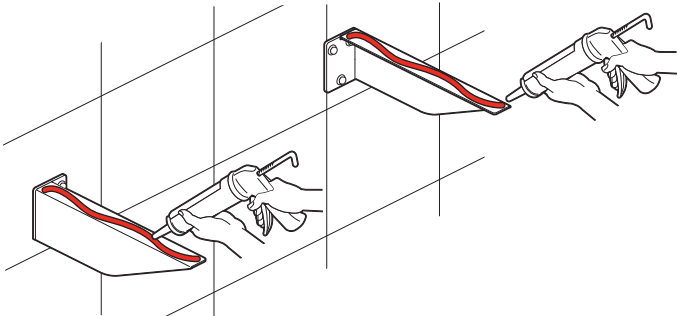

7

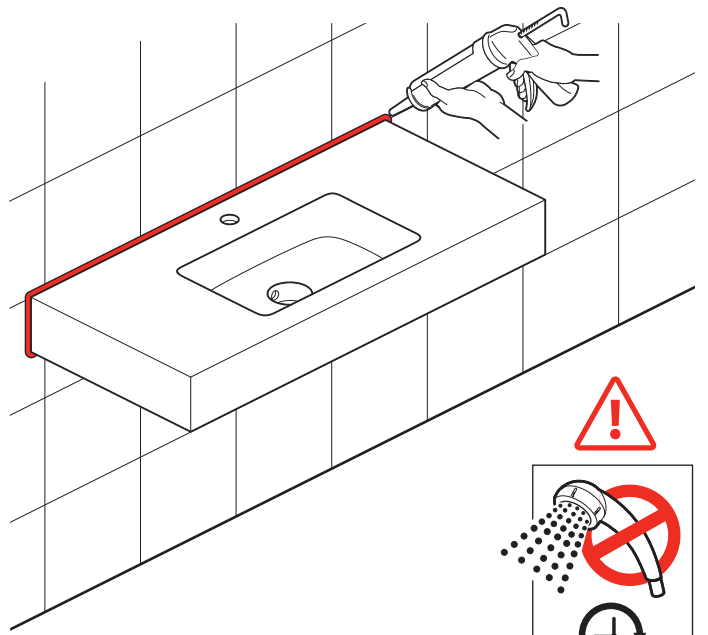

12 h

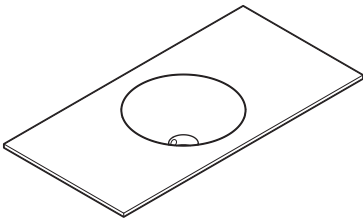

Ref: A525771000

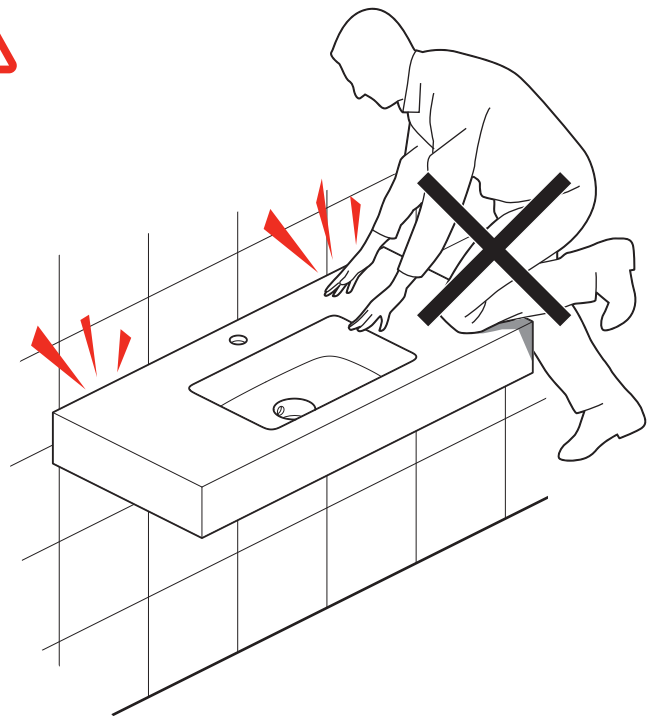



Roca Sanitario, S.A.
Avda. Diagonal, 513
08029 Barcelona
SPAIN
www.roca.com

933 LÍNEA DE ATENCIÓN
661 AL CONSUMIDOR
266 ESPAÑA 
SERVICIO TÉCNICO
ESPAÑA 

productsupport.rs@roca.net
soporteproducto.rs@roca.net