

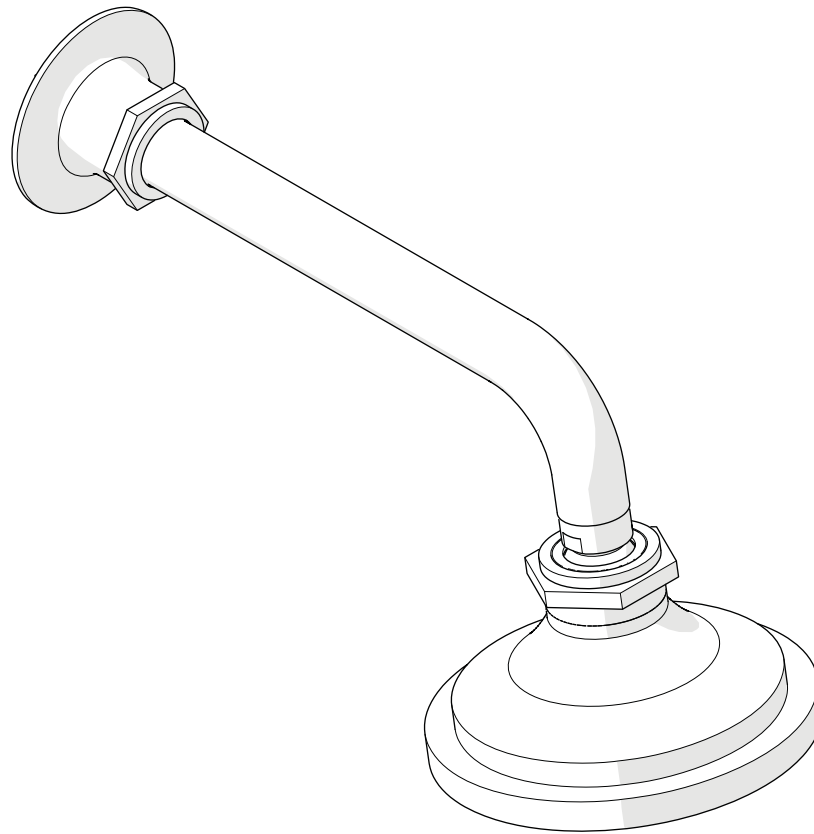

ESTB. 1978

WATERWORKS SERVICE PARTS



STYLE HNSH10

Henry 5" Shower Head, Arm and Flange with Adjustable Spray

WELCOME TO

WATERWORKS

For over three decades, Waterworks has transformed the bath through an absolute commitment to design authenticity, innovation and quality. A blend of scholarly appreciation and applied experience guarantees mechanical integrity, meticulous craftsmanship, and timeless designs.

**TO ORDER PARTS CALL
1 (800) 927-2120 (EXT 2)**

Order by part number and specify color, finish, or other options if required.

PRODUCT SUPPORT

Our Product Support team provides troubleshooting and technical problem resolution, including replacement parts and installation recommendations throughout the life of your product.

Product Support is available Monday through Friday, 8AM-6PM EST.

**LIMITED LIFETIME
WARRANTY**

Our warranty covers repair and replacement of Waterworks products if within the applicable coverage period and deemed defective by Waterworks. Waterworks will, at its option, repair or replace such products; this does not include installation costs, labor charges, or other incidental or consequential costs.

To obtain your complete warranty or inquire about warranty service, please visit us at www.waterworks.com or contact our Product Support Team.



ESTB. 1978

WATERWORKS

MAIN KITS

STYLES: HNSH10

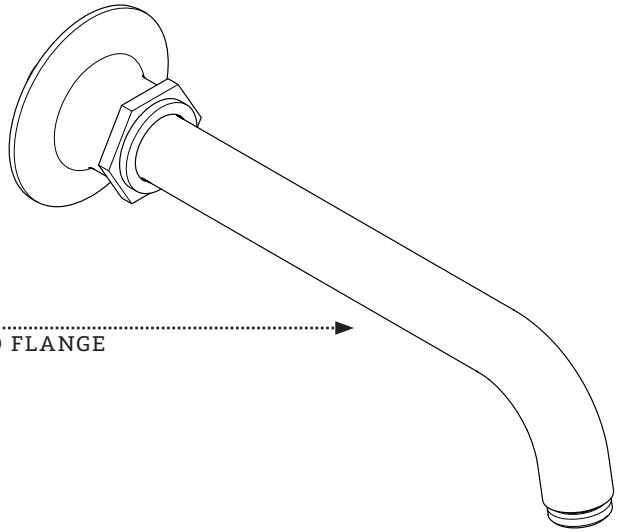

103757*
ARM AND FLANGE

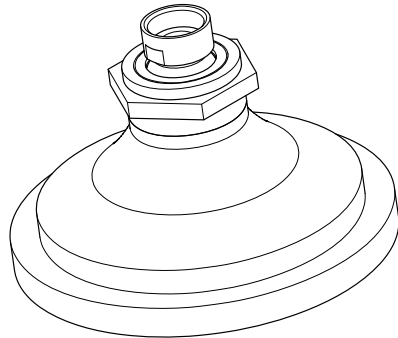

103756*
SHOWERHEAD

*FINISH/COLOR MUST BE SPECIFIED WHEN ORDERING
++SUPPLIED AS A PAIR

KIT COMPONENTS

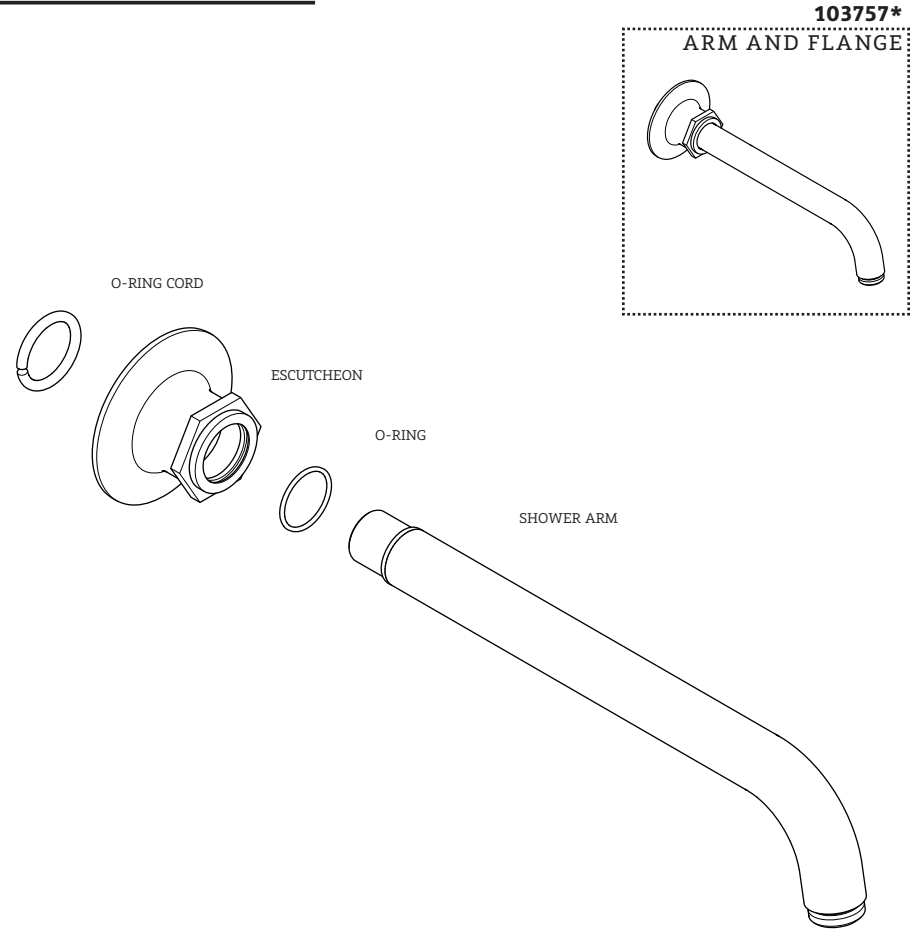



ESTB. 1978

WATERWORKS

KIT COMPONENTS

STYLES: HNSH10

RETAINING COLLAR

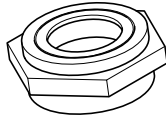

PLASTIC WASHER



RUBBER WASHER



FLOW REGULATOR



PIVOT BALL



O-RING



SHOWERHEAD

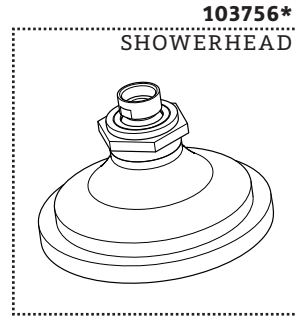
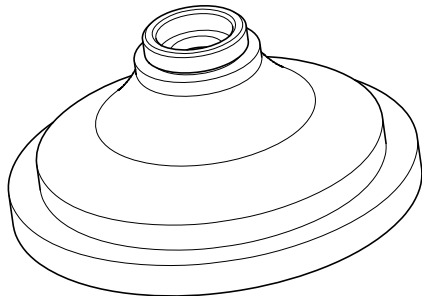

*FINISH/COLOR MUST BE SPECIFIED WHEN ORDERING
++SUPPLIED AS A PAIR

SERVICE PARTS INDEX

<u>STYLE</u>	<u>DESCRIPTION</u>	<u>PG</u>
103757*	ARM AND FLANGE	3
103756*	SHOWERHEAD	4



ESTB. 1978

WATERWORKS

PRODUCT SUPPORT

60 BACKUS AVENUE
DANBURY, CT 06810

1 (800) 927-2120 (EXT 2)

WWW.WATERWORKS.COM