

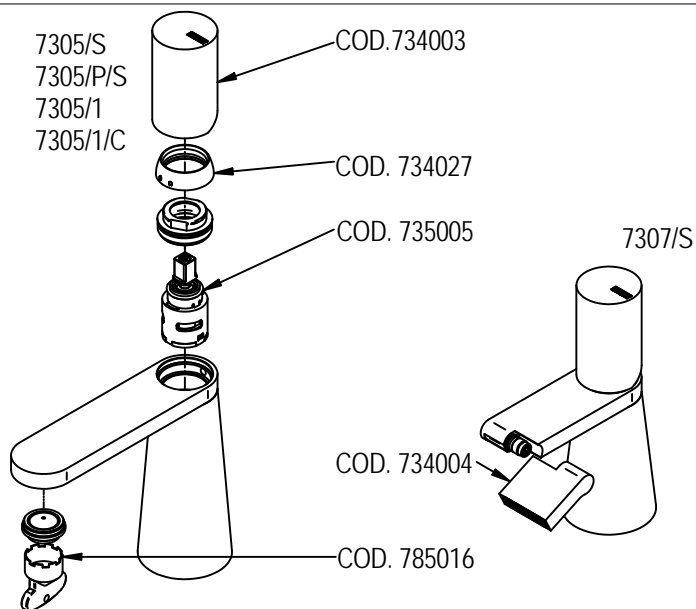

RICAMBI / SPARE PARTS



Iudo

Istruzioni di installazione / Installation instruction

Art. 7305/S
Art. 7305/P/S



Art. 7305/1
Art. 7305/1/C



Art. 7307/S



Per installatore: Al fine di garantire la durata del prodotto installare rubinetti sottolavabo con filtro da pulire periodicamente. Effettuare risciacquo delle tubazioni prima di installare il prodotto (PUNTO 1) Eventuali residui se finissero all'interno della cartuccia potrebbero causare il danneggiamento

For installer: In order to guarantee a long duration of the product install angle valves with filter, which have to be regularly cleaned (POINT 1). Carry out the rinsing of the pipes before install the tap. Some external materials may damage the cartridge if not removed before installation

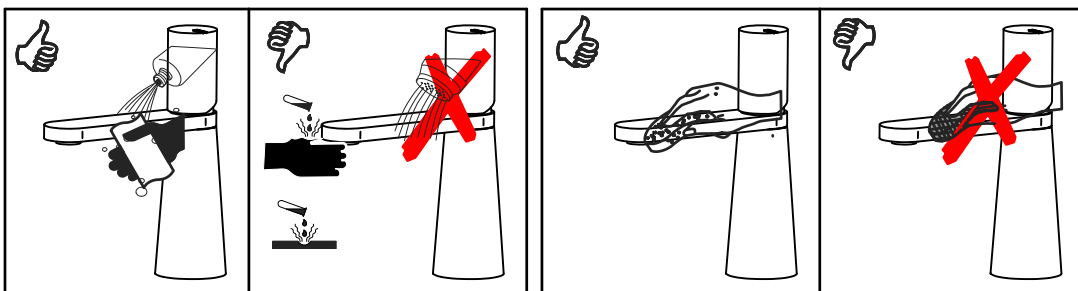

MANUTENZIONE E PULIZIA

Per una corretta manutenzione e pulizia di questo prodotto, raccomandiamo alcuni semplici accorgimenti:

- Utilizzare detersivi neutri, spruzzando il prodotto direttamente su un panno morbido onde evitare infiltrazioni
- Evitare sempre il contatto con prodotti acidi o abrasivi
- Risciacquare bene con abbondante acqua per eliminare eventuali residui ed asciugare sempre con un panno morbido
- Effettuare una pulizia periodica al fine di prevenire le formazioni calcaree

La BELLOSTA CARLO & C. non è RESPONSABILE di danni derivati dall'utilizzo di prodotti impropri per la pulizia.

MAINTENANCE AND CLEANING

For a proper maintenance and cleaning, we recommend the following:

- Use neutral detergents, avoiding to spray directly on taps to avoid residual infiltration
- Avoid contact with acid or abrasive products
- Rinse with water and always dry with a clean cloth to avoid residue of detergent
- Perform a periodic cleaning to prevent limestone deposits

BELLOSTA CARLO & C. cannot be held responsible for damages due to an improper use of detergents

ufficio tecnico
BELLOSTA
S.F. 10/16 ISO 9001:2015



9001-2015 I

socio sostenitore

associato

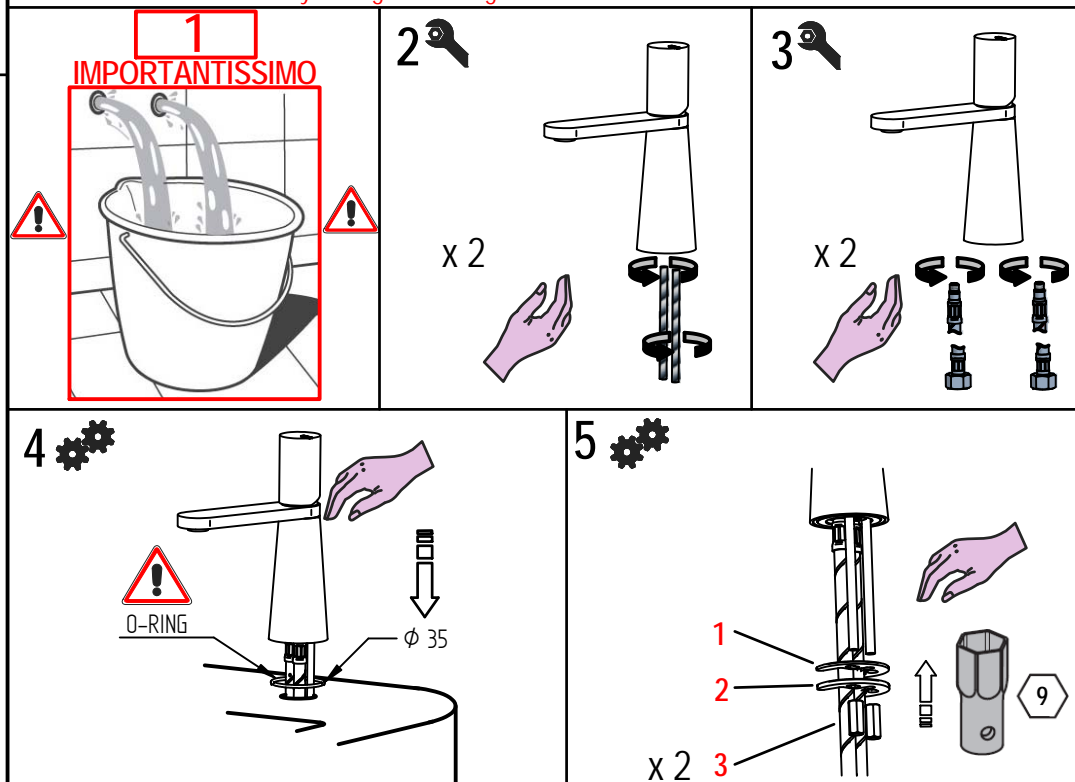

MADE IN ITALY

DESIGN MADE IN ITALY

Questo prodotto è stato realizzato interamente in Italia con l'utilizzo di materie prime di altissima qualità

David Dolcini

This product has been entirely manufactured in Italy, by top quality raw materials.



Rubinetti d'autore dedicati a te

6

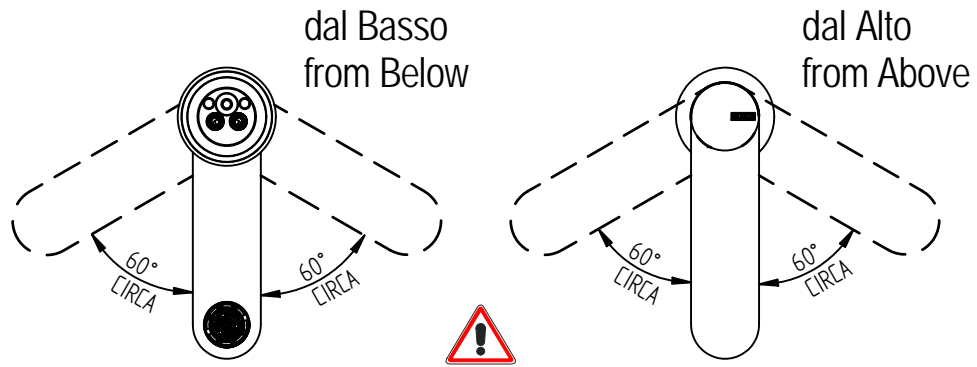

7

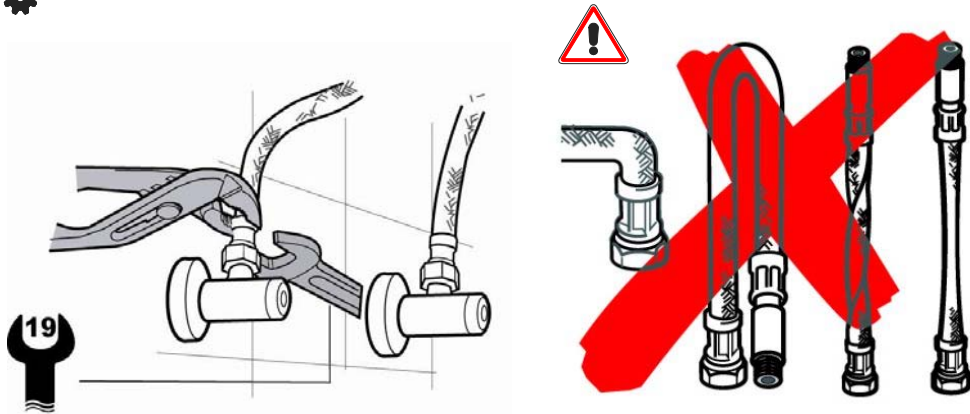

8

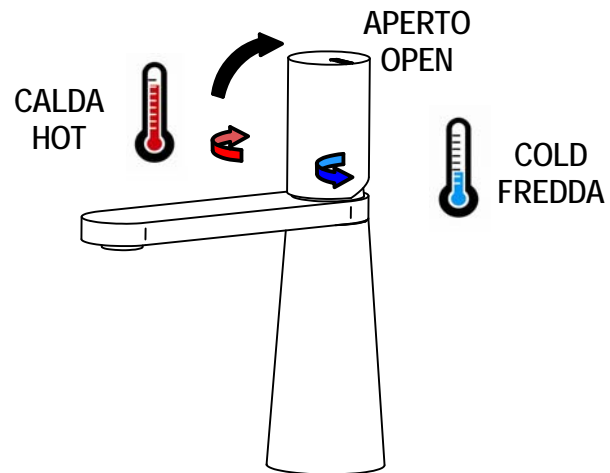

SOSTITUZIONE CARTUCCIA / CARTRIDGE REPLACEMENT

Prima di iniziare le operazioni di sostituzione della cartuccia assicurarsi che l'acqua dell'impianto principale sia chiusa e che la cartuccia sia svuotata da residui di acqua.

Before starting replacement of cartridge, ensure that water system has been turned off and empty remaining water.

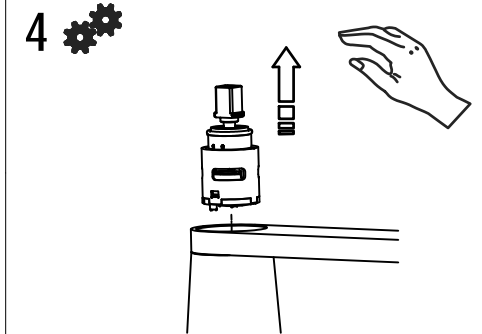
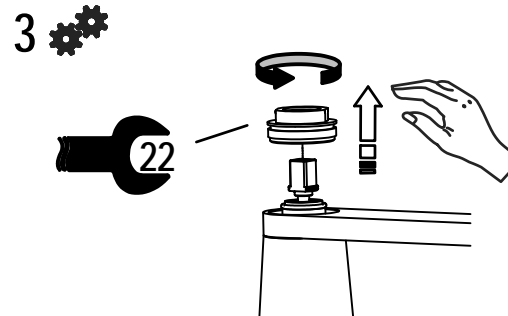
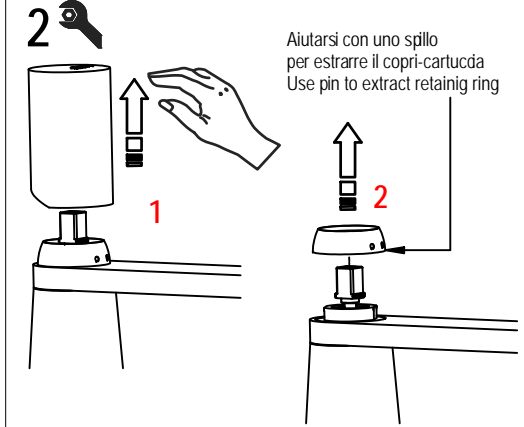
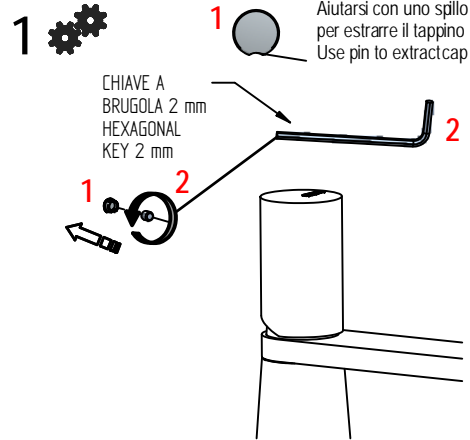

SOSTITUZIONE AERATORE / AERATOR REPLACEMENT

