

TABLETOP SOAP DISPENSER, LOCKABLE WP193



Ø 65 x 328 x 165 mm

chrome-plated brass

- Tabletop soap dispenser, lockable, in chrome-plated brass.
- Solid body in brass; visible surfaces high-gloss chrome-plated.
- Design height: 80 mm
Outlet height: 45 mm
Projection: 111 mm
- Non-drip soap pump with 500 ml soap container in plastics and pressure valve in brass.
- Also available with 250 ml or 1000 ml containers in plastics.
- 500 ml container in stainless steel as an option for a surcharge.
- Designed for standard liquid soaps.
- Refillable from above by unscrewing the top part, secured with hexagon socket screw.
- Wear parts can be replaced as modules.
- Installation dimensions: Ø 22-26 mm,
Surface thickness max. 40 mm.
- Mounting: With one counternut.
- Delivery includes fixing material.
- Weight, including single package: 1.3 kg



Suggested text for specifications:

Tabletop soap dispenser, lockable, in chrome-plated brass for counter mounting. Solid body in brass; visible surfaces high-gloss chrome-plated. Non-drip soap pump with 500 ml soap container in plastics and pressure valve in brass. Designed for standard liquid soaps. Refillable from above by unscrewing the top part, secured with hexagon socket screw. Delivery includes fixing material.

Dimensions: (with container) 65 x 328 x 165 mm

Design height: 80 mm

Outlet height: 45 mm

Projection: 111 mm

Article No. WP193

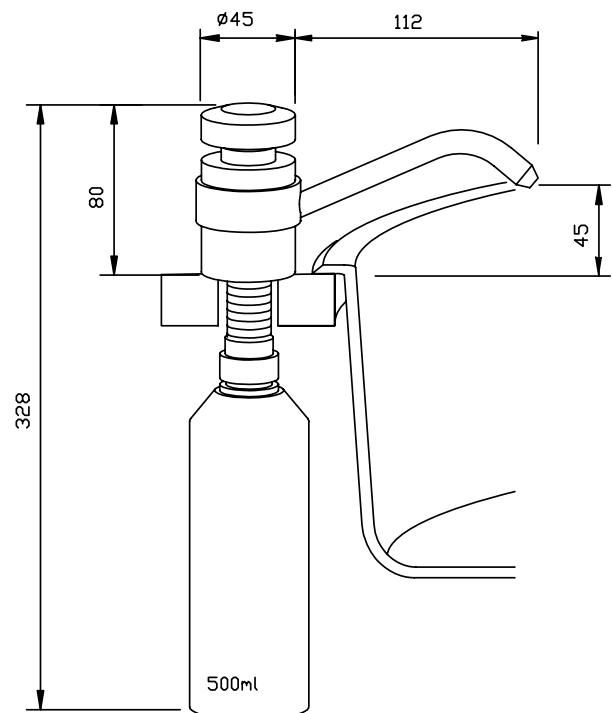

Available surface	ID No.
chrome-plated	923 151

Ernst Wagner GmbH & Co. KG

Ernst-Abbe-Straße 21 · D-72770 Reutlingen · Tel.: +49712151539-0 · Fax: -20
info@wagner-ewar.de · www.wagner-ewar.de

WAGNER
EWAR