

Hafa® Go

Art.nr 1580300, 1580301, 1580302

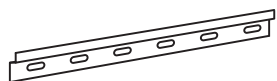

1 x a

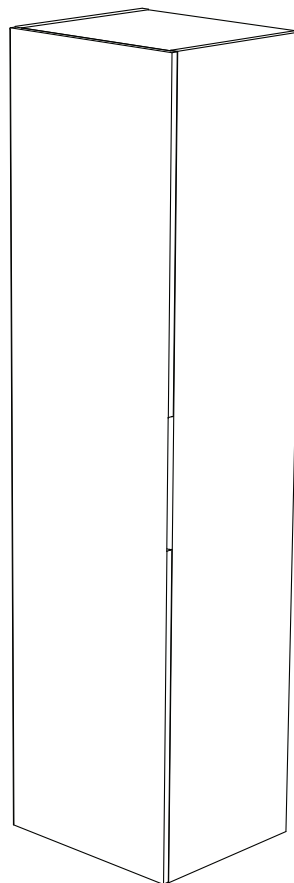

1 x b

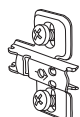

3 x c

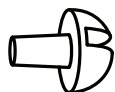

16 x d



38 x e

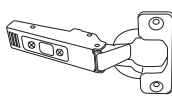

1 x f



6 x h

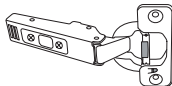

2 x g

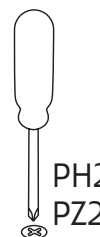

PH2
PZ2



SILICONE

Hafa®

Hafa
Svarvaregatan 5, Box 525
SE-301 80 Halmstad
SWEDEN

Garanti/Warranty.
Service, reservdelar/spare parts
Sweden: Tel: +46 (0)35 15 44 75
Norway: Tel: +47 (0)69 31 02 30
Finland: Puh: +358 (0)9 61500940

www.hafa.se
www.hafa.dk
www.hafabad.no
www.hafa.se
www.hafabathroom.ru
www.hafa.eu

E-mail:
service@hafa.se
service@hafabad.no



(SE) Rekommendation (DK) Anbefale (NO) Anbefale (FI) Suositus (GB) Recommendation

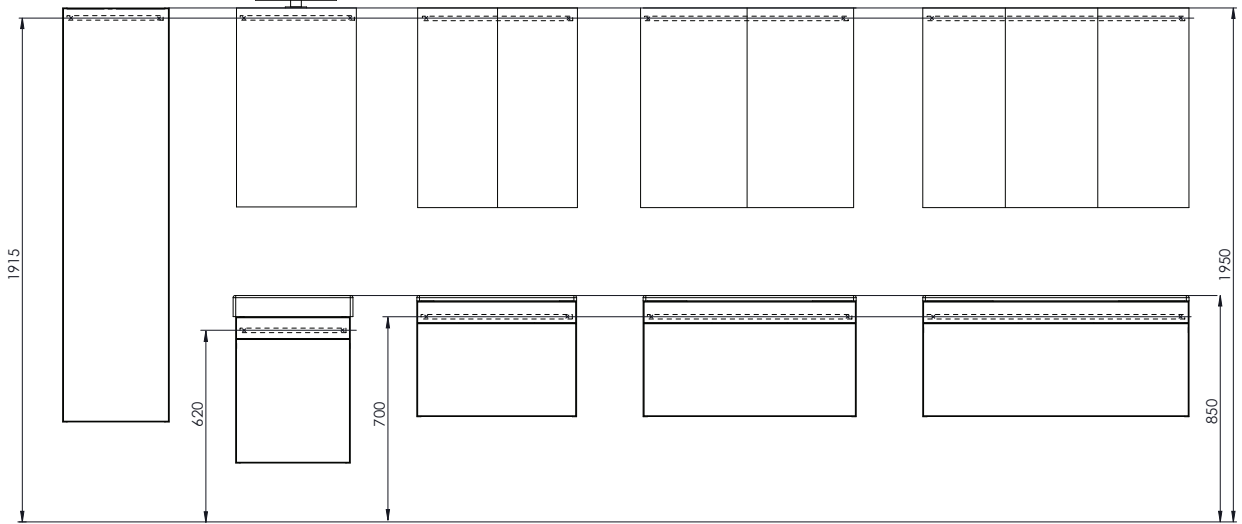

1

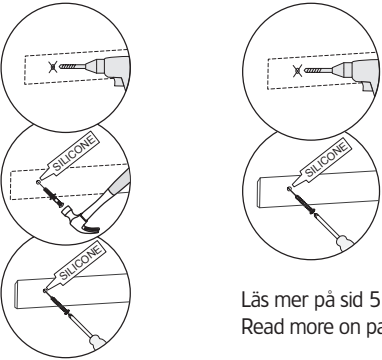
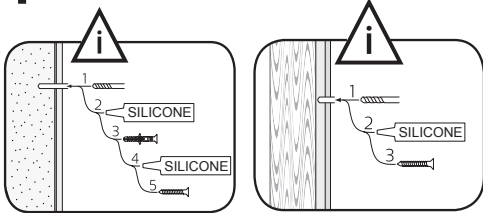

Läs mer på sid 5
Read more on page 5



OBS! Använd skruv som passar ditt väggmaterial
OBS! Brug den skrue, der passer til dine vægmaterialer
OBS! Bruk skruer som passer til veggmaterialet
HUOM! Käytä seinämateriaaliin sopivaa ruuvia
NOTE! Use screws suitable for your wall material

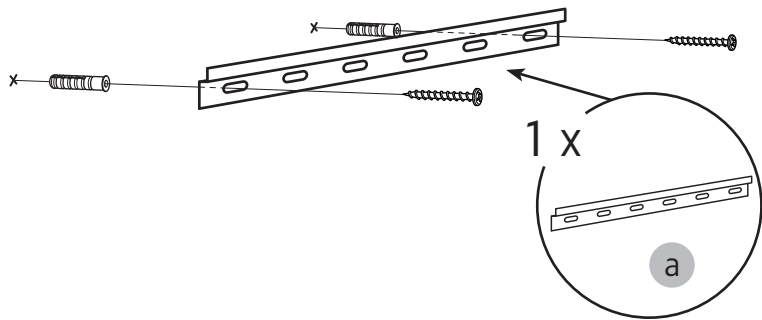

2

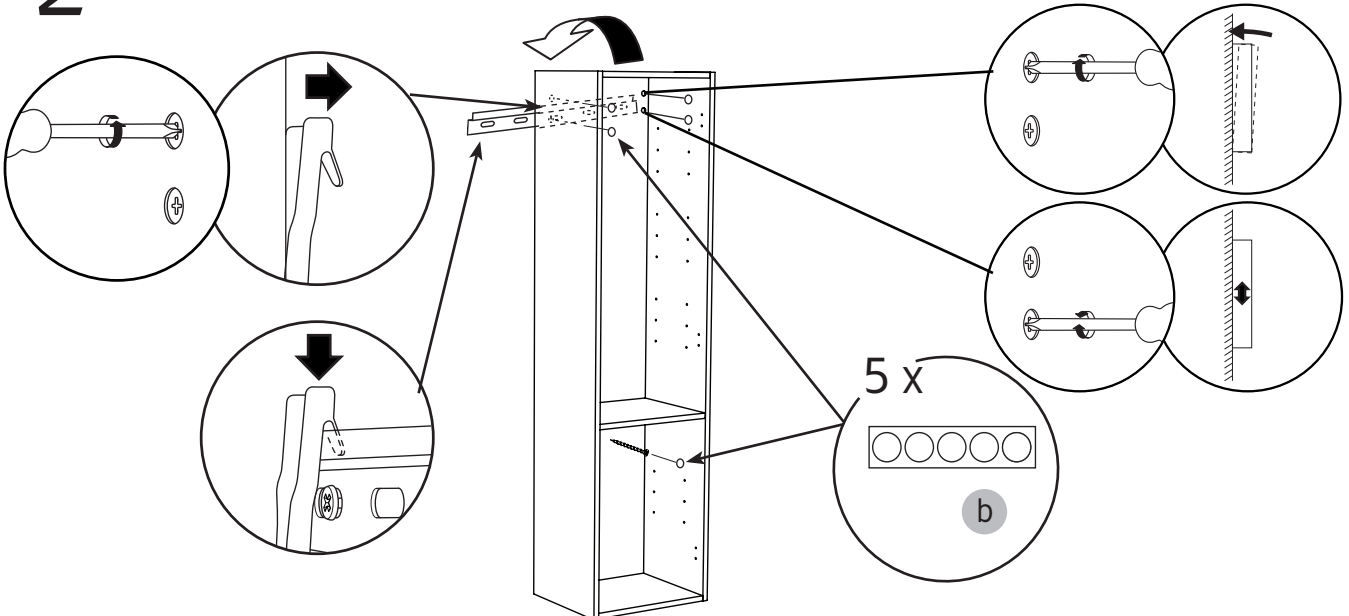

3

i

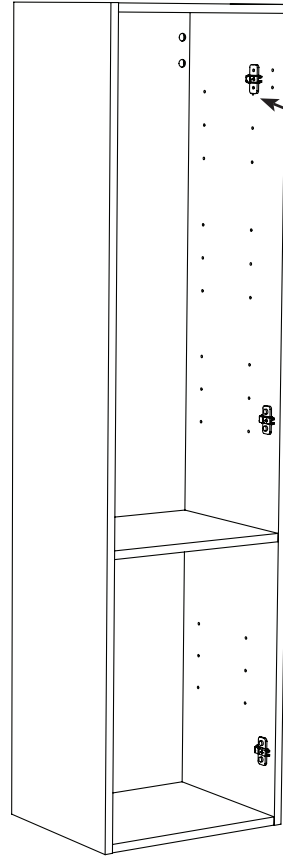
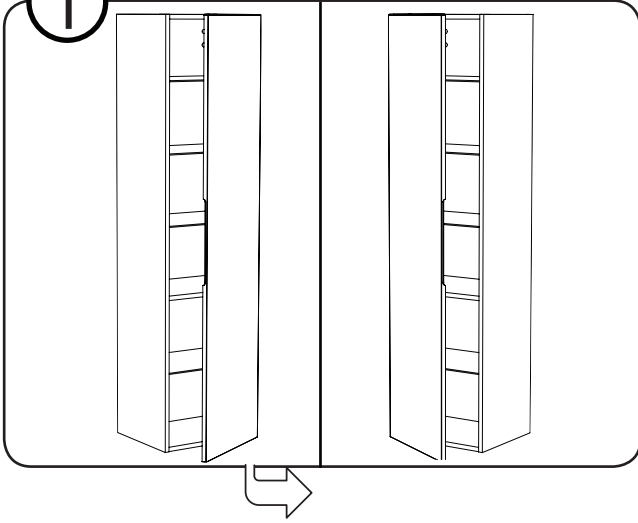

3 x

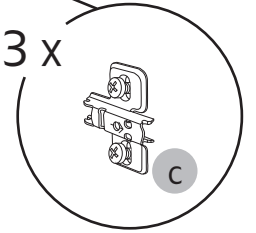

4

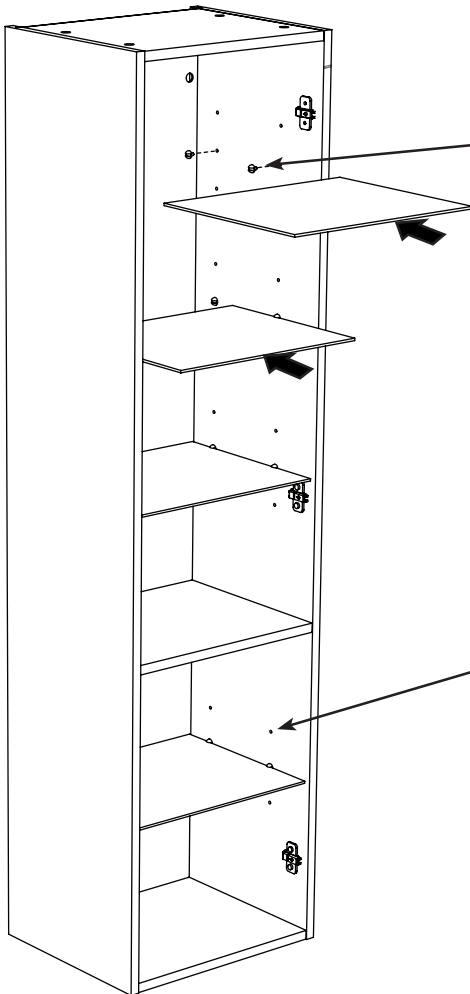

16 x

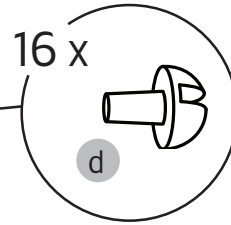

38 x

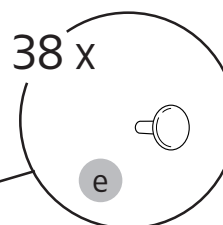

5

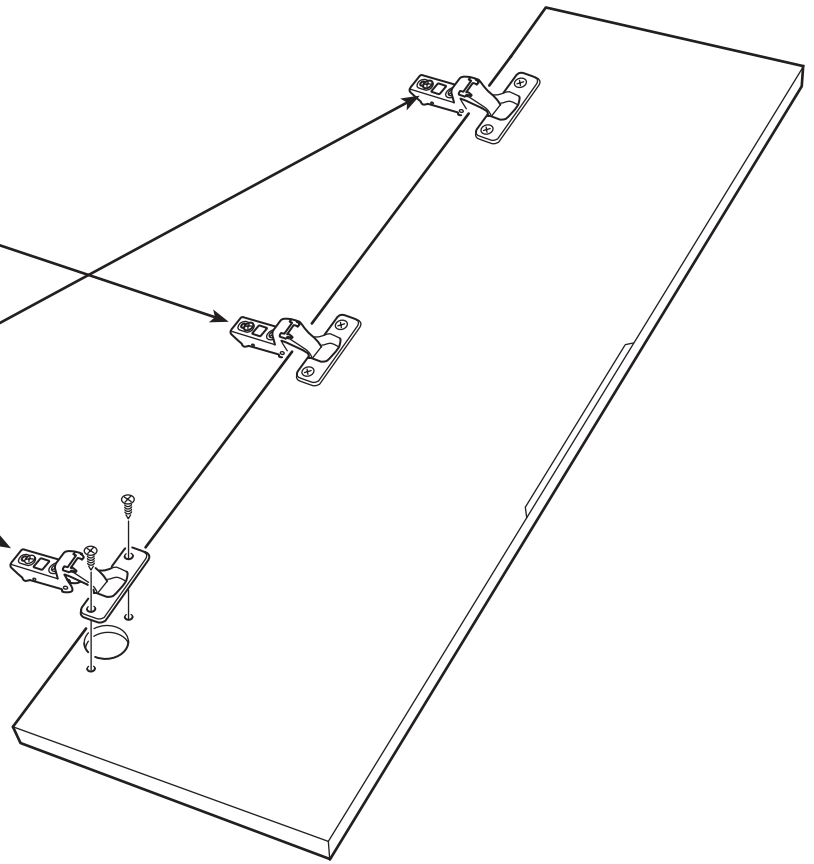
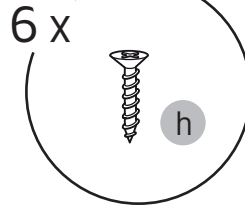
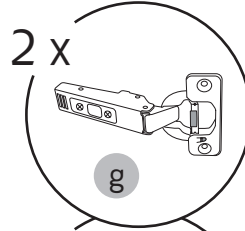
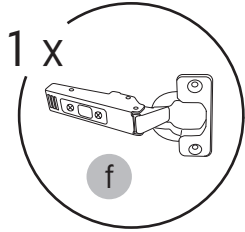

6

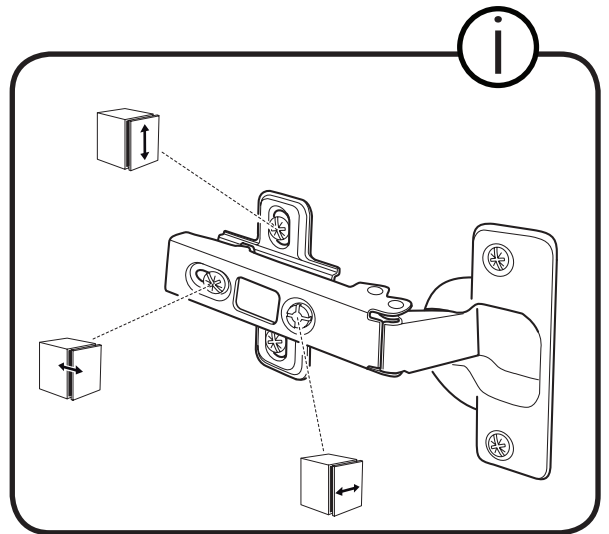
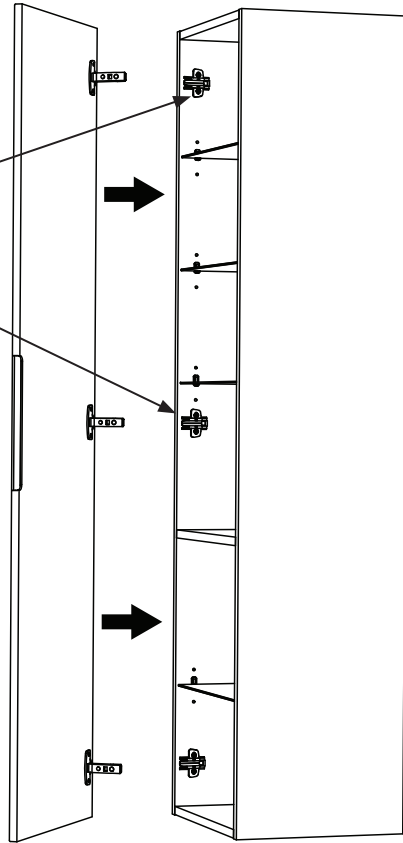
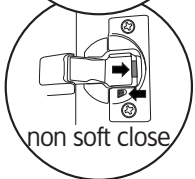
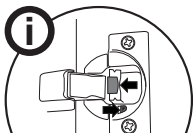
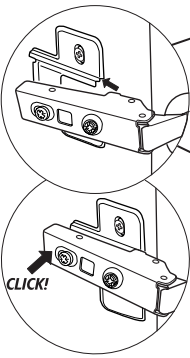

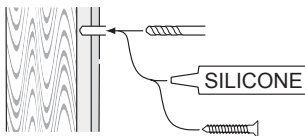

alt.

SE

Skruvinfästningar ska göras i betong eller annan massiv konstruktion, träreglar, träkortlingar eller i konstruktion som är provad och godkänd för infästning, till exempel skivkonstruktion. Se exempel på godkända konstruktioner på sakervatten.se. Material för tätning ska fästa mot underlaget och vara vattenbeständigt, mögelresistent och åldersbeständigt. Krav på tätning gäller både i våtzon 1 och 2.

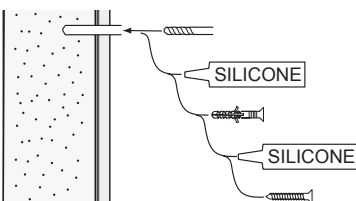

GB

Below are Swedish recommendations:

Screw fastenings should be made in concrete or other solid structure, wooden studs, wooden noggings or in structures that have been tested and approved for fastenings, for example a sheet construction. See examples of approved constructions at sakervatten.se. Sealing substances must fixate to the materials it aims to seal, be waterproof, mould-resistant and age-resistant. Requirements for sealing apply in wet zones 1 and 2.



**Accepterad
monteringsanvisning
2016:1**

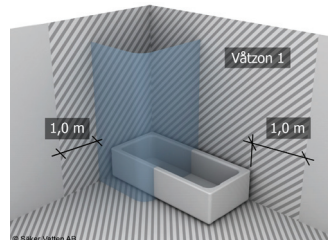

	<p>Hafa Svarvaregatan 5, Box 525 SE-301 80 Halmstad SWEDEN</p>	<p>Garanti/Warranty. Service, reservdelar/spare parts Sweden: Tel: +46 (0)35 15 44 75 Norway: Tel: +47 (0)69 31 02 30 Finland: Puh: +358 (0)9 61500940</p>	<p>www.hafa.se www.hafa.dk www.hafabad.no www.hafa.se www.hafabathroom.ru www.hafa.eu</p>	<p>E-mail: service@hafa.se service@hafabad.no</p>
---	--	--	--	--