

TABLETOP SOAP DISPENSER WP192-3



Ø 68 x 456 x 170 mm

stainless steel

- Tabletop soap dispenser in robust, germ-reducing and easy-care stainless steel (AISI 316L).
- Solid stainless steel body; visible surfaces satin finished. Further available surfaces: see below.
- Design height: 208 mm
Outlet height: 198 mm
Projection: 111 mm
- Non-drip soap pump with 500 ml soap bottle in plastics and pressure valve in stainless steel.
- Also available with 250 ml or 1000 ml containers in plastics.
- 500 ml container in stainless steel as an option for a surcharge.
- Designed for standard liquid soaps.
- Refillable from above by unscrewing the top part.
- Wear parts can be replaced as modules.
- Installation dimensions: Ø 22-26 mm, surface thickness max. 40 mm.
- Mounting: With one counternut.
- Delivery includes fixing material.
- Weight, including single package: 1.7 kg



Suggested text for specifications:

Tabletop soap dispenser in stainless steel (AISI 316L) for counter mounting. Solid stainless steel body; visible surfaces satin finished. Non-drip soap pump with 500 ml soap bottle in plastics and pressure valve in stainless steel. Designed for standard liquid soaps. Refillable from above by unscrewing the top part. Delivery includes fixing material.

Dimensions: (with container) 65 x 456 x 160 mm

Design height: 208 mm

Outlet height: 198 mm

Projection: 111 mm

Article No. WP192-3

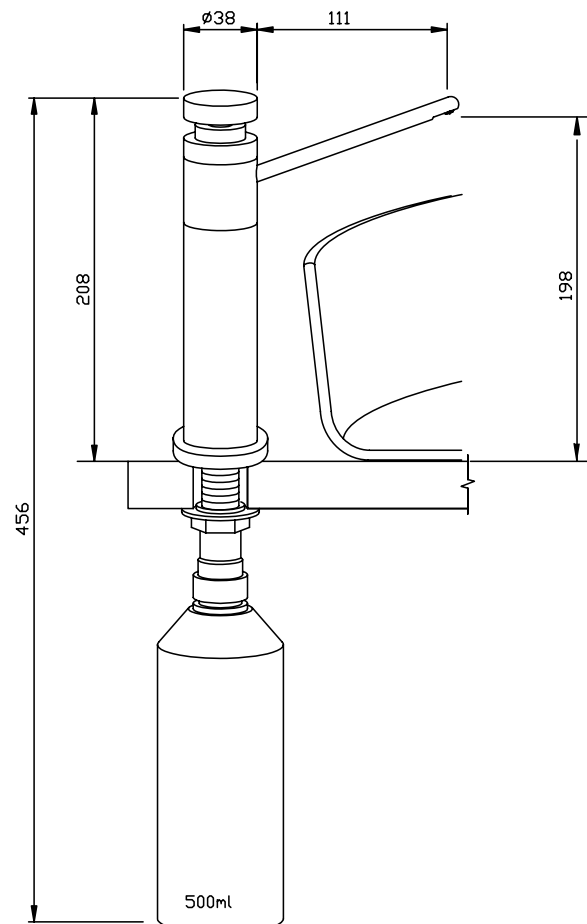

Options	ID No.
Washer / rosette	923 159
Available surfaces	ID No.
satin finished (standard)	923 371
highly polished	931 371

Ernst Wagner GmbH & Co. KG

Ernst-Abbe-Straße 21 · D-72770 Reutlingen · Tel.: +49712151539-0 · Fax: -20
info@wagner-ewar.de · www.wagner-ewar.de

WAGNER
EWAR