

Features

- Single-speed whirlpool offers performance and value, with 8 fully adjustable jets.
- Hydromassage flow and direction can be controlled at each jet.
- Built-in heater.
- Comfort Depth® design offers a convenient 19" step-over height while retaining the same depth as a standard 21" bath.
- Molded lumbar support offers extra comfort while bathing.
- Slotted overflow allows for deep soaking.
- Integral apron.
- Integral flange helps prevent water from seeping behind wall and simplifies alcove installation.
- Textured bottom surface.
- Coordinates with other products in the Archer collection.

Material

- Acrylic.

Hydrotherapy

- Whirlpool.

Installation

- Right drain.
- Alcove.

Required Products/Accessories

K-7271 Brass Slotted Overflow Bath Drain

or

K-7272 PVC Slotted Overflow Bath Drain

Recommended Products/Accessories

K-24916 Wireless Music Kit

K-23726 Drain treatment

K-23732 Tub & shower cleaner



ADA

Codes/Standards

ASME A112.19.7/CSA B45.10

CSA B45.5/IAPMO Z124

UL 1795

CSA C22.2 No. 218.2

ADA

ICC/ANSI A117.1











**KOHLER® Plastic Baths and Receptors
Lifetime Limited Warranty**

**KOHLER® Hydrotherapy Components
Five-Year Limited Warranty**

See website for detailed warranty information.

Available Colors/Finishes

Color tiles intended for reference only.

Color	Code	Description
	0	White
	96	Biscuit
	47	Almond
	NY	Dune
	95	Ice™ Grey
	G9	Sandbar
	33	Mexican Sand™
	K4	Cashmere
	58	Thunder™ Grey
	7	Black Black™

No change in measurements if connected with drain illustrated. (K-7272)

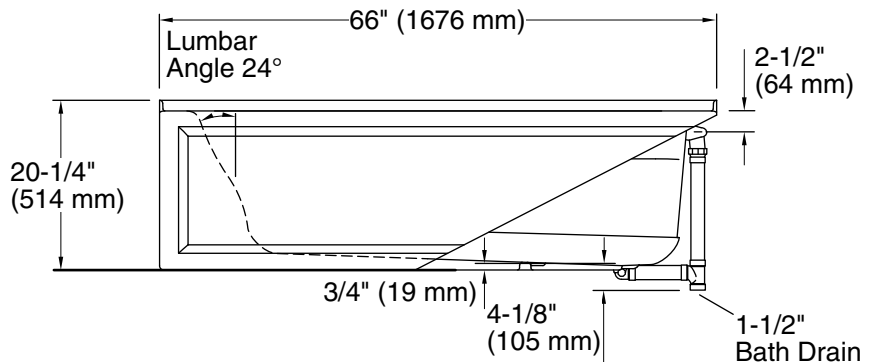
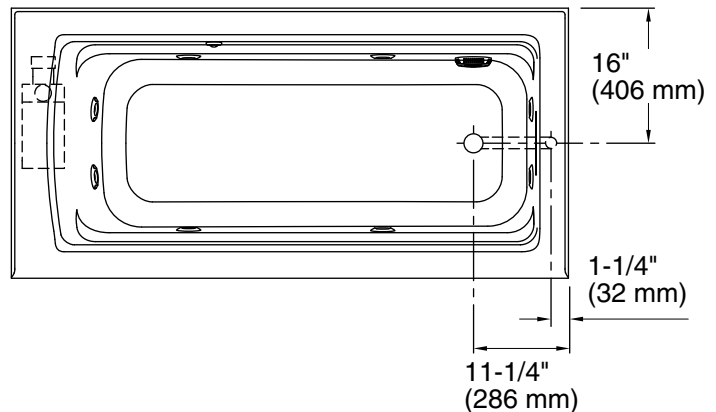
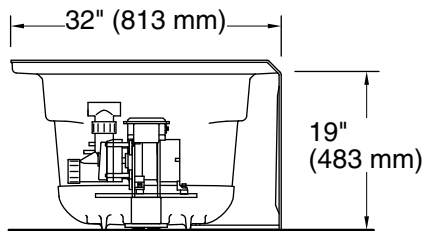
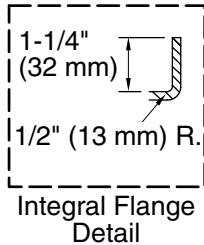

Required Electrical Service

Two dedicated circuits required, protected with Class A Ground-Fault Circuit-Interrupter (GFCI). Outside North America, this device may be known as a Residual Current Device (RCD).

Pump: 120 V, 15 A, 60 Hz
Heater: 120 V, 15 A, 60 Hz

Technical Information

All product dimensions are nominal.

Installation: Three-wall alcove
Drain location: Right
Basin area, bottom: 50-3/8" x 19-5/8" (1280 mm x 498 mm)
Basin area, top: 57-5/16" x 24-1/16" (1456 mm x 611 mm)
Weight: 120 lbs (54.4 kg)
Minimum floor load: 47 lbs/ft² (229.5 kg/m²)
Water depth: 15-5/16" (389 mm)
Water capacity: 66 gal (249.8 L)
Electrical component rating: Pump: 120 V, 7 A, 60 Hz
Heater: 120 V, 12.5 A, 60 Hz, 1500 W
Pump speed: Single
Minimum flat for door: 2-3/16" (55 mm)

Notes

Measure your actual product for rough-in details. Install this product according to the installation instructions.
The hot water supply should be 70% of the capacity of the bath or greater. Installations will vary.
ADA compliant when installed to the specific requirements of these regulations.