

COMBINATION SENSOR-SOAP/PAPER/WASTE WP510E



298 x 1348 x 120 mm

950 ml sensor soap, 250 paper towels, 11 l waste bin

- Combination consisting of a sensor liquid soap dispenser, a paper towel dispenser and a waste bin in robust, germ-reducing and easy-care stainless steel (AISI 304).
- All-stainless steel housing; all corners fully welded, visible surfaces satin finished and brushed. Further available surfaces: see below.
- Sensor liquid soap dispenser with EWAR® eModule touch-free operated soap pump.
- Designed for standard 950 ml disposable bottles of liquid soap or hand lotion.
- Also refillable with large container using the plug-in tank as an option.
- Paper towel dispenser with deep-drawn paper removal opening for easy paper removal.
- Designed for approx. 250 standard paper towels in zigzag fold. Paper size (folded): 240-250 mm x 100-115 mm.
- Inspection slots to indicate fill level.
- Accessible for refilling through lockable front flap with fall protection.
- Waste bin equipped with removable mesh basket. Capacity approx. 11 l. Accessible through lockable door with self-closing, flame-retardant disposal flap.
- Keyed alike cylinder locks in corrosion-resistant zinc die-casting.
- eModule battery-powered with two 1.5 V Baby/LR14 batteries. Power supply available as an option.
- Wear parts can be replaced as modules.
- Mounting: With eight screws through key holes and one optional anti-theft hole in the back wall.
- Delivery includes fixing material, batteries, first fill with soap and one pack of paper towels.
- Weight, including single package: 14.8 kg



Suggested text for specifications:

Combination consisting of a sensor liquid soap dispenser, a paper towel dispenser and a waste bin in stainless steel (AISI 304) for surface mounting. All-stainless steel housing; all corners fully welded, visible surfaces satin finished and brushed. Sensor liquid soap dispenser with touch-free operated soap pump. Designed for standard 950 ml disposable bottles of liquid soap or hand lotion. Paper towel dispenser with deep-drawn paper removal opening, filling quantity approx. 250 paper towels. Inspection slots to indicate fill level. Accessible for refilling through lockable front flap with fall protection. Waste bin equipped with removable mesh basket. Capacity approx. 11 l. Accessible through lockable door with self-closing, flame-retardant disposal flap. Keyed alike cylinder locks in corrosion-resistant zinc die-casting. Delivery includes fixing material, batteries, first fill with soap and one pack of paper towels.

Dimensions: 298 x 1348 x 120 mm

Article No. WP510e

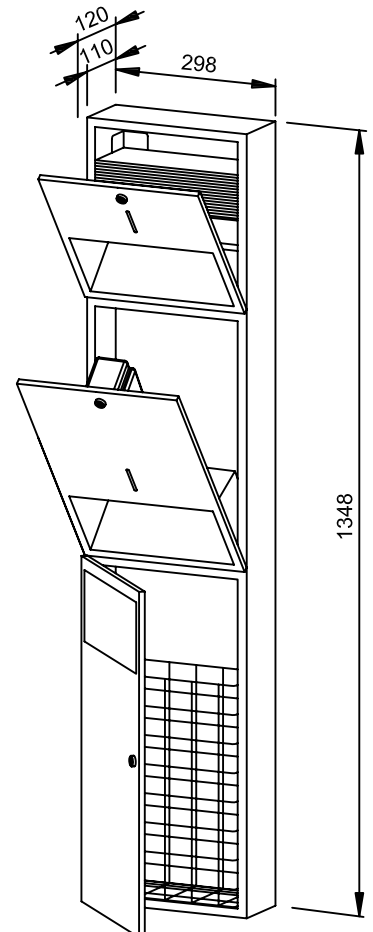

Options	ID No.
Power supply for eModule	923 060

Available surfaces	ID No.
satin finished (standard)	727 745
highly polished	731 745
(coloured) plastic powder-coating	728 745

Ernst Wagner GmbH & Co. KG

Ernst-Abbe-Straße 21 · D-72770 Reutlingen · Tel.: +49712151539-0 · Fax: -20
info@wagner-ewar.de · www.wagner-ewar.de

WAGNER
EWAR