

### Features

- Includes face plate with handle.
- Single handle controls temperature setting.
- Supplied with ADA compliant metal lever handle.
- Complements the Finial® faucet and accessory collections.

### Material

- Premium material construction with metal handle ensures reliability and durability.
- KOHLER finishes resist corrosion and tarnishing.

### Installation

- Trim set requires valve to complete installation (sold separately).
- Patented K-joint installation technology ensures consistent trim appearance, regardless of variability in valve rough-in.

### Required Products/Accessories

K-2975-KS 3/4" Thermostatic Mixing Valve

or

K-2972-KS 1/2" Thermostatic Mixing Valve

### Recommended Products/Accessories

K-23723 Faucet cleaner



ADA CSA B651 OBC

### Codes/Standards





ASME A112.18.1/CSA B125.1  
ADA  
ICC/ANSI A117.1  
CSA B651  
OBC

### KOHLER® Faucet Lifetime Limited Warranty

See website for detailed warranty information.

### Available Colors/Finishes

*Color tiles intended for reference only.*

Color	Code	Description
	CP	Polished Chrome
	SN	Vibrant® Polished Nickel
	AF	Vibrant® French Gold
	PB	Vibrant® Polished Brass
	BN	Vibrant® Brushed Nickel
	BV	Vibrant® Brushed Bronze
	BRZ	Oil-Rubbed Bronze
	2BZ	Oil-Rubbed Bronze

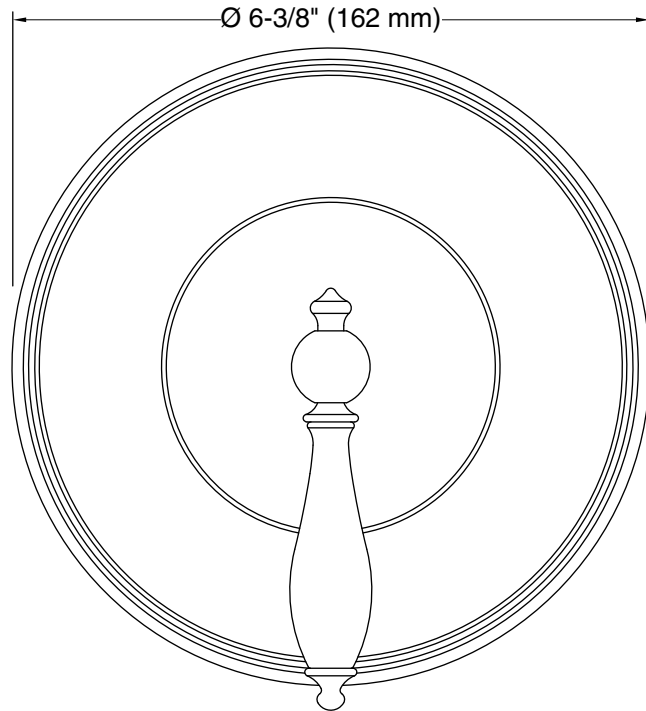
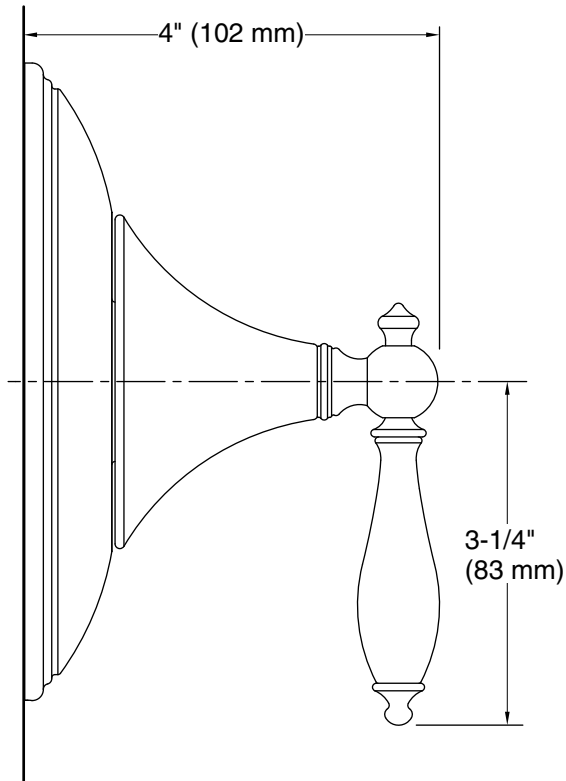

**Technical Information**

All product dimensions are nominal.

**Notes**

Install this product according to the installation instructions.

ADA, OBC, CSA B651 compliant when installed to the specific requirements of these regulations.