

Features

- Low-threshold design for easy entry and exit.
- Recessed right drain.
- Single threshold for three-wall installation.
- Requires K-9330 Groove aluminum drain cover or K-9334 Groove teak drain cover (sold separately).

Material

- Acrylic.

Required Products/Accessories

K-9330 Drain Cover

or

K-9334 Drain Cover

Recommended Products/Accessories

K-9132 Shower Drain

K-23726 Drain treatment

K-23732 Tub & shower cleaner



Codes/Standards

CSA B45.5/IAPMO Z124

ASTM E162







ASTM E662

KOHLER® Plastic Baths and Receptors Lifetime Limited Warranty

See website for detailed warranty information.

Available Colors/Finishes

Color tiles intended for reference only.

| Color | Code | Description |
|--|------|---------------|
|  | 0 | White |
|  | 96 | Biscuit |
|  | 47 | Almond |
|  | NY | Dune |
|  | 95 | Ice™ Grey |
|  | G9 | Sandbar |
|  | 33 | Mexican Sand™ |

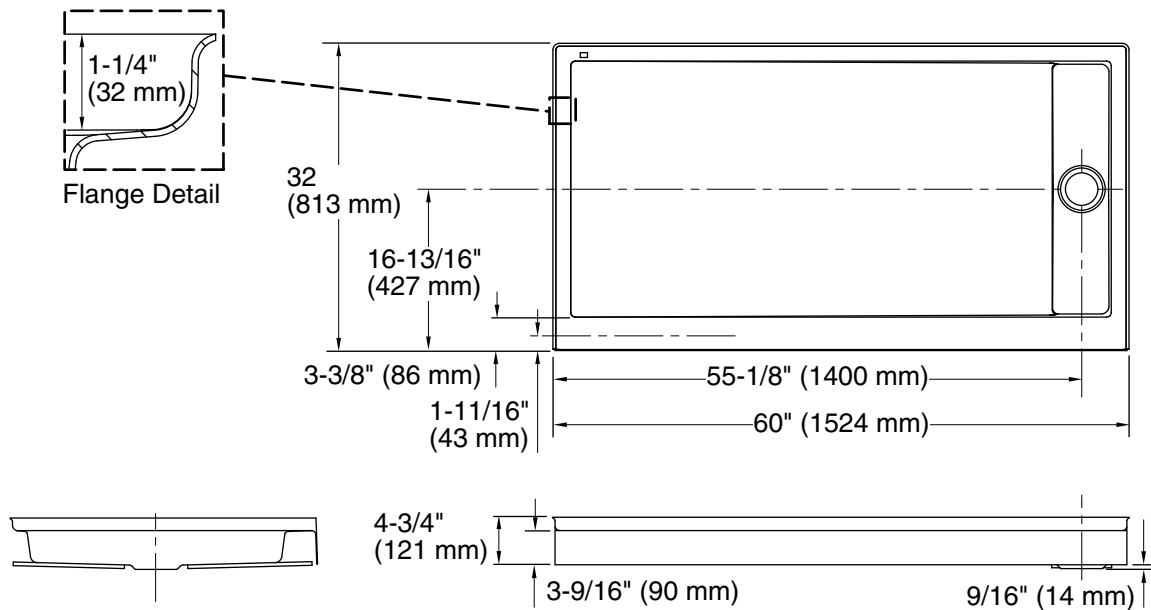

Technical Information

All product dimensions are nominal.

Installation: Three-wall alcove

Drain location: Right

Weight: 65 lbs (29.5 kg)

Minimum floor load: 20 lbs/ft² (97.6 kg/m²)

Notes

Measure your actual product for rough-in details.

Install this product according to the installation instructions.

Shimming may be required to level the fixture.

Shimming may be required between the stud frame and the fixture.

Stud opening tolerance is + 1/4" (6 mm), - 0" (0 mm).